

IES Indoor Report

Photometric Filename:AD10681(D)(D5)-12W-3500K-RA90-60D-WH.IES

Indoor Luminaire Photometric Data

Description Information

Luminaire Name:AD10681 (D) (D5)-12W-3500K-RA90-60D-WH	Lum. Catalog: 天花板灯	Test ID:
Lamp Name: CLU701-1002C4-353H5K2	Lamp Catalog: COB	Test Date: 2022/06/05
Manufacture:	Shld. Ang(°):60	Test Machine:GON-2000
Test Lab: Test	Frequency(Hz):50	Lamp CCT(K): 3500 Ra: 90
Lum. Size (W*L*H):0.000m*0.000m*0.000m	Lum. Area(m2):0.000	Lum. W(kg): 0.000
Test System: C, γ	Test Step: C=30.0 γ =1.0	Temp. (°C): 25
		Humidity(%): 50.0

Character Parameter

Lamp Speciality Parameter		Luminaire Speciality Parameter	
Rated Flux(lm): 750.000	Luminaire Flux(lm): 656.828	Field Angle(10%Imax): 85.6(°)	
Rated Power(W): 12	Luminaire Efficiency: 87.58%	Down Lumens&Percent: 603.186lm 91.83%	
Rated Voltage(V): 220	Luminaire EER(lm/W): 61.443	Up Lumens&Percent: 53.642lm 8.17%	
Tested Power(W): 10.690	Max. Candela(cd): 762.133	S/MH: C0_a180=0.769 C90_270=0.767	
Lamps' Inside: 1	Max Cand@Ang.(°): C=180.0 γ =2.0	CIE Type: Semi-Direct	
Tested Electrics(V, A, pf):221.0, 0.087, 0.553	Beam Angle(50%Imax): 48.9(°)	ErP Φ use(90°): 540.049lm	
Lamp Size(W*L*H):0.000m*0.000m*0.000m	Left=-22.5°, Right=26.4°	IRF(%): 285.596	

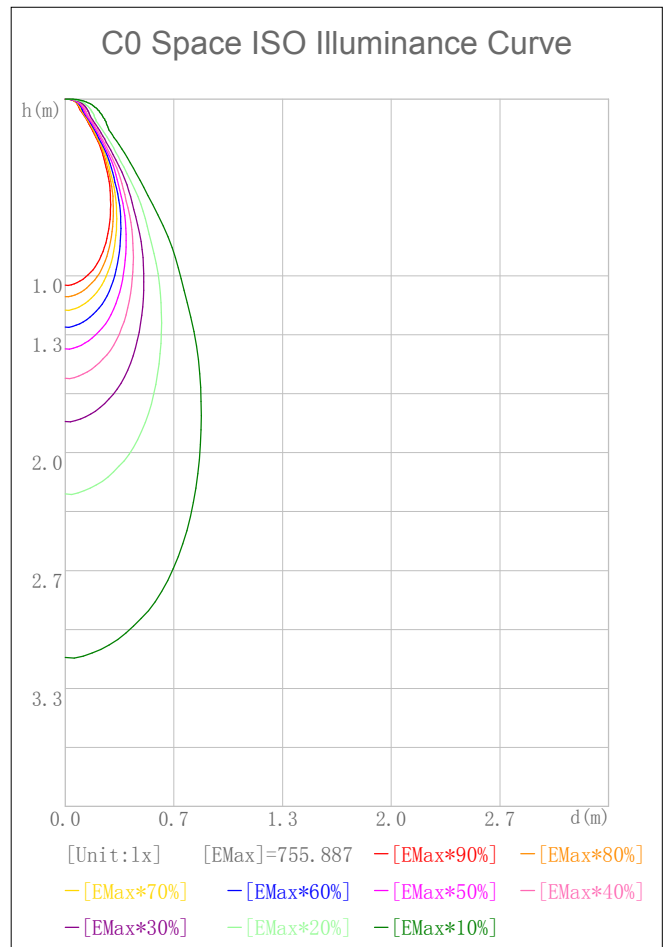
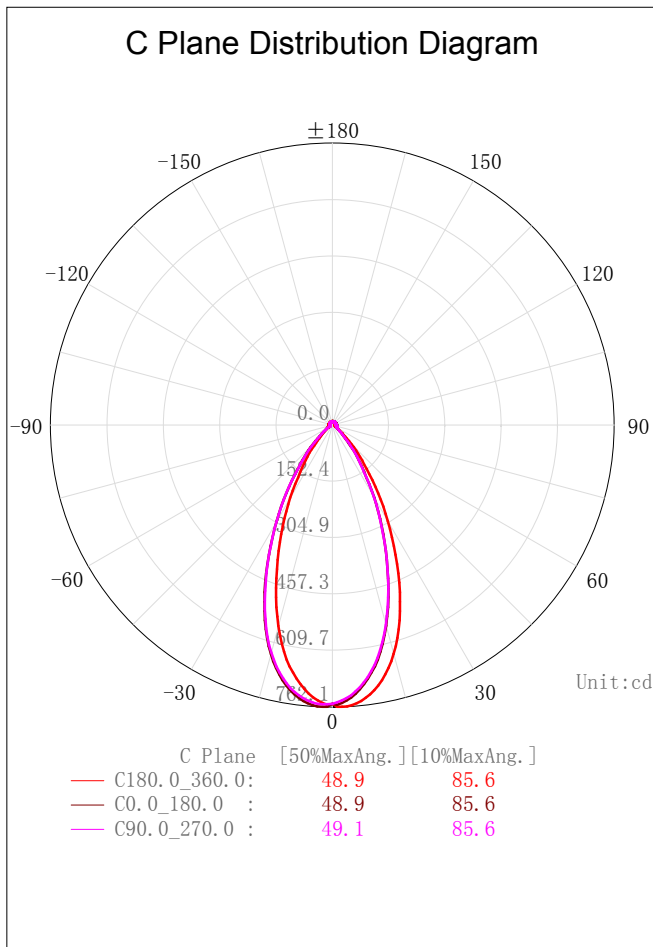

IES Indoor Report

Photometric Filename:AD10681(D)(D5)-12W-3500K-RA90-60D-WH.IES

2D Plane Light Intensity Distribution Curve

Lum. Name: AD10681(D)(D5)-12W-3500K-RA90-60D-WH	Lum. Catalog: 天花灯	Test ID:
Lamp Name: CLU701-1002C4-353H5K2	Lamp Catalog: COB	Test Lab: Test
Manufacture:	Test Machine:GON-2000	Test Date: 2022/06/05

C Plane Distribution Diagram

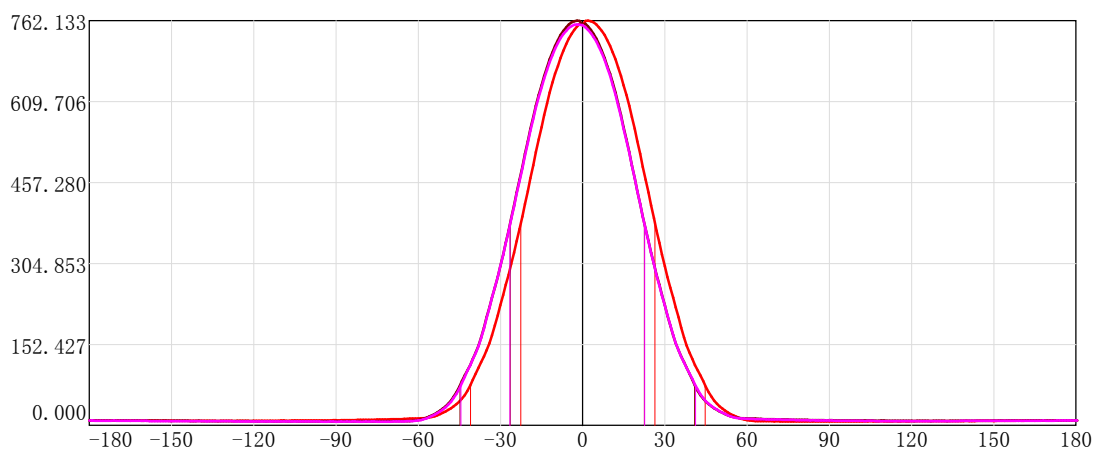
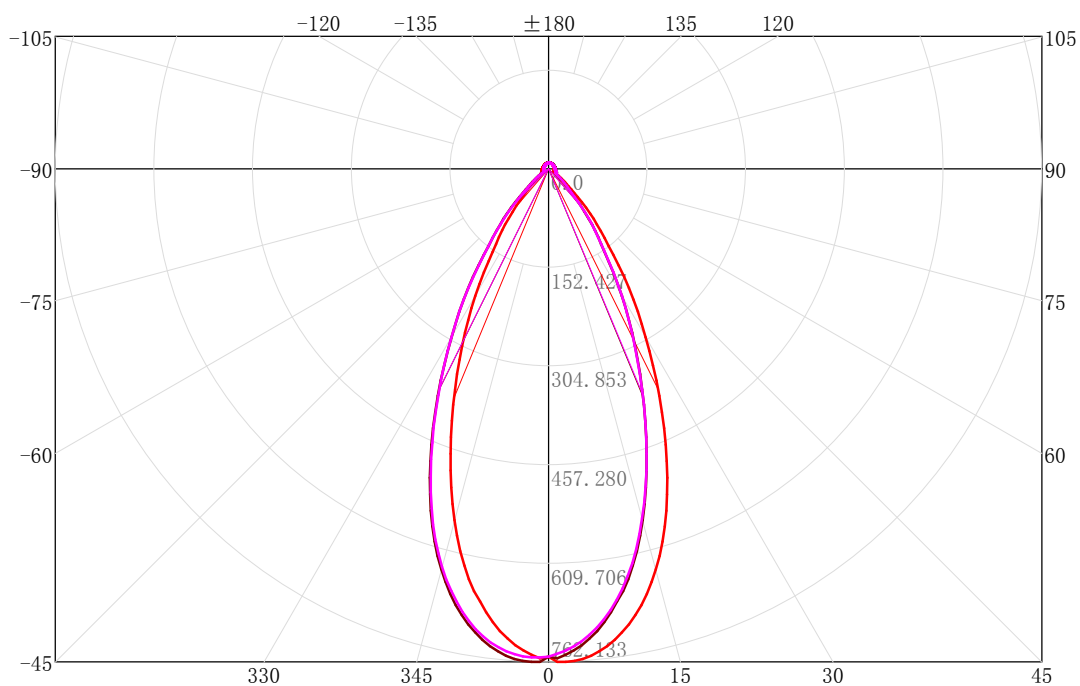

	C Plane	[50%MaxAng.]	[10%MaxAng.]	Unit:cd
—	C180.0_360.0:	48.9	85.6	
—	C0.0_180.0 :	48.9	85.6	
—	C90.0_270.0 :	49.1	85.6	

IES Indoor Report

Photometric Filename:AD10681(D)(D5)-12W-3500K-RA90-60D-WH.IES

3D Light Intensity Distribution Modal

Lum. Name: AD10681(D)(D5)-12W-3500K-RA90-60D-WH	Lum. Catalog: 天花灯	Test ID:
Lamp Name: CLU701-1002C4-353H5K2	Lamp Catalog: COB	Test Lab: Test
Manufacture:	Test Machine:GON-2000	Test Date: 2022/06/05

3D Light Intensity Distribution Modal

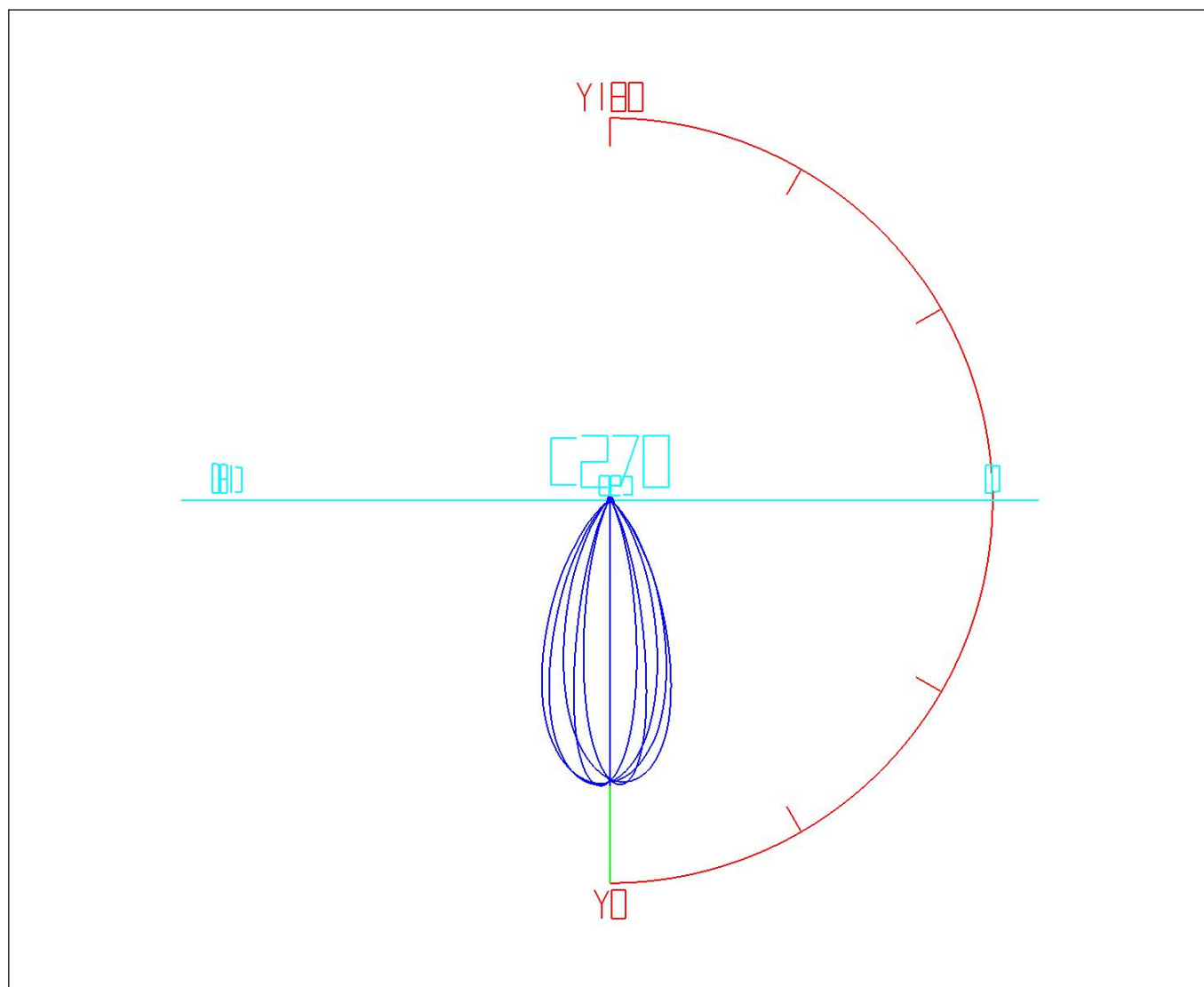

Curves: 3D Model ——— Fixture ——— Vert. HUD ——— Hori. HUD ———
View Angles: Orient:0 Tilt:0 Roll:0 Spin:0

IES Indoor Report

Photometric Filename:AD10681(D)(D5)-12W-3500K-RA90-60D-WH.IES

Zonal Flux Tabulation

Zone (γ)	Zone Flux (lm)	Sums Flux (lm)	Zone%Lamp	Sums%Lamp	Zone (γ)	Zone Flux (lm)	Sums Flux (lm)	Zone%Lamp	Sums%Lamp
0.0-1.0	0.72	0.72	0.10	0.10	47.0-48.0	3.38	551.56	0.45	73.54
1.0-2.0	2.16	2.88	0.29	0.38	48.0-49.0	3.03	554.59	0.40	73.95
2.0-3.0	3.58	6.46	0.48	0.86	49.0-50.0	2.73	557.32	0.36	74.31
3.0-4.0	4.99	11.45	0.67	1.53	50.0-51.0	2.47	559.79	0.33	74.64
4.0-5.0	6.36	17.82	0.85	2.38	51.0-52.0	2.22	562.02	0.30	74.94
5.0-6.0	7.70	25.52	1.03	3.40	52.0-53.0	2.00	564.01	0.27	75.20
6.0-7.0	8.99	34.51	1.20	4.60	53.0-54.0	1.80	565.81	0.24	75.44
7.0-8.0	10.23	44.73	1.36	5.96	54.0-55.0	1.62	567.44	0.22	75.66
8.0-9.0	11.40	56.13	1.52	7.48	55.0-56.0	1.47	568.91	0.20	75.85
9.0-10.0	12.50	68.63	1.67	9.15	56.0-57.0	1.34	570.25	0.18	76.03
10.0-11.0	13.53	82.16	1.80	10.95	57.0-58.0	1.23	571.48	0.16	76.20
11.0-12.0	14.46	96.62	1.93	12.88	58.0-59.0	1.16	572.64	0.15	76.35
12.0-13.0	15.30	111.92	2.04	14.92	59.0-60.0	1.10	573.74	0.15	76.50
13.0-14.0	16.04	127.96	2.14	17.06	60.0-61.0	1.06	574.80	0.14	76.64
14.0-15.0	16.68	144.64	2.22	19.29	61.0-62.0	1.04	575.83	0.14	76.78
15.0-16.0	17.21	161.85	2.29	21.58	62.0-63.0	1.02	576.86	0.14	76.91
16.0-17.0	17.63	179.49	2.35	23.93	63.0-64.0	1.02	577.88	0.14	77.05
17.0-18.0	17.94	197.43	2.39	26.32	64.0-65.0	1.01	578.89	0.14	77.19
18.0-19.0	18.13	215.56	2.42	28.74	65.0-66.0	1.01	579.90	0.13	77.32
19.0-20.0	18.21	233.77	2.43	31.17	66.0-67.0	1.01	580.91	0.13	77.45
20.0-21.0	18.19	251.97	2.43	33.60	67.0-68.0	1.00	581.91	0.13	77.59
21.0-22.0	18.08	270.05	2.41	36.01	68.0-69.0	0.99	582.90	0.13	77.72
22.0-23.0	17.88	287.93	2.38	38.39	69.0-70.0	0.99	583.89	0.13	77.85
23.0-24.0	17.60	305.53	2.35	40.74	70.0-71.0	0.99	584.88	0.13	77.98
24.0-25.0	17.25	322.79	2.30	43.04	71.0-72.0	0.99	585.87	0.13	78.12
25.0-26.0	16.84	339.63	2.25	45.28	72.0-73.0	0.98	586.85	0.13	78.25
26.0-27.0	16.37	356.00	2.18	47.47	73.0-74.0	0.98	587.84	0.13	78.38
27.0-28.0	15.86	371.86	2.11	49.58	74.0-75.0	0.98	588.82	0.13	78.51
28.0-29.0	15.31	387.17	2.04	51.62	75.0-76.0	0.98	589.80	0.13	78.64
29.0-30.0	14.71	401.88	1.96	53.58	76.0-77.0	0.97	590.78	0.13	78.77
30.0-31.0	14.07	415.95	1.88	55.46	77.0-78.0	0.97	591.75	0.13	78.90
31.0-32.0	13.38	429.34	1.78	57.25	78.0-79.0	0.97	592.72	0.13	79.03
32.0-33.0	12.65	441.99	1.69	58.93	79.0-80.0	0.96	593.68	0.13	79.16
33.0-34.0	11.90	453.89	1.59	60.52	80.0-81.0	0.96	594.64	0.13	79.29
34.0-35.0	11.17	465.05	1.49	62.01	81.0-82.0	0.96	595.59	0.13	79.41
35.0-36.0	10.44	475.49	1.39	63.40	82.0-83.0	0.95	596.55	0.13	79.54
36.0-37.0	9.71	485.19	1.29	64.69	83.0-84.0	0.95	597.50	0.13	79.67
37.0-38.0	9.03	494.22	1.20	65.90	84.0-85.0	0.95	598.45	0.13	79.79
38.0-39.0	8.40	502.63	1.12	67.02	85.0-86.0	0.95	599.40	0.13	79.92
39.0-40.0	7.78	510.41	1.04	68.05	86.0-87.0	0.95	600.35	0.13	80.05
40.0-41.0	7.15	517.55	0.95	69.01	87.0-88.0	0.95	601.30	0.13	80.17
41.0-42.0	6.53	524.09	0.87	69.88	88.0-89.0	0.95	602.24	0.13	80.30
42.0-43.0	5.94	530.02	0.79	70.67	89.0-90.0	0.94	603.19	0.13	80.42
43.0-44.0	5.35	535.37	0.71	71.38	90.0-91.0	0.94	604.13	0.13	80.55
44.0-45.0	4.77	540.15	0.64	72.02	91.0-92.0	0.94	605.07	0.13	80.68
45.0-46.0	4.25	544.39	0.57	72.59	92.0-93.0	0.93	606.00	0.12	80.80
46.0-47.0	3.78	548.18	0.50	73.09	93.0-94.0	0.93	606.93	0.12	80.92

-
-
-

IES Indoor Report

Photometric Filename:AD10681(D)(D5)-12W-3500K-RA90-60D-WH.IES

Zonal Flux Tabulation - (Cont.)

Zone (γ)	Zone Flux (lm)	Sums Flux (lm)	Zone%Lamp	Sums%Lamp	Zone (γ)	Zone Flux (lm)	Sums Flux (lm)	Zone%Lamp	Sums%Lamp
94.0-95.0	0.93	607.86	0.12	81.05	141.0-142.0	0.59	644.83	0.08	85.98
95.0-96.0	0.93	608.79	0.12	81.17	142.0-143.0	0.58	645.40	0.08	86.05
96.0-97.0	0.92	609.71	0.12	81.29	143.0-144.0	0.56	645.97	0.08	86.13
97.0-98.0	0.92	610.63	0.12	81.42	144.0-145.0	0.56	646.52	0.07	86.20
98.0-99.0	0.92	611.54	0.12	81.54	145.0-146.0	0.55	647.07	0.07	86.28
99.0-100.0	0.92	612.46	0.12	81.66	146.0-147.0	0.54	647.61	0.07	86.35
100.0-101.0	0.91	613.37	0.12	81.78	147.0-148.0	0.52	648.13	0.07	86.42
101.0-102.0	0.90	614.28	0.12	81.90	148.0-149.0	0.50	648.63	0.07	86.48
102.0-103.0	0.90	615.17	0.12	82.02	149.0-150.0	0.49	649.12	0.07	86.55
103.0-104.0	0.90	616.07	0.12	82.14	150.0-151.0	0.48	649.60	0.06	86.61
104.0-105.0	0.89	616.97	0.12	82.26	151.0-152.0	0.46	650.07	0.06	86.68
105.0-106.0	0.89	617.85	0.12	82.38	152.0-153.0	0.45	650.52	0.06	86.74
106.0-107.0	0.88	618.73	0.12	82.50	153.0-154.0	0.44	650.96	0.06	86.79
107.0-108.0	0.87	619.60	0.12	82.61	154.0-155.0	0.43	651.38	0.06	86.85
108.0-109.0	0.87	620.47	0.12	82.73	155.0-156.0	0.41	651.80	0.05	86.91
109.0-110.0	0.86	621.33	0.11	82.84	156.0-157.0	0.40	652.19	0.05	86.96
110.0-111.0	0.85	622.18	0.11	82.96	157.0-158.0	0.38	652.58	0.05	87.01
111.0-112.0	0.85	623.03	0.11	83.07	158.0-159.0	0.37	652.94	0.05	87.06
112.0-113.0	0.84	623.87	0.11	83.18	159.0-160.0	0.35	653.29	0.05	87.11
113.0-114.0	0.83	624.71	0.11	83.29	160.0-161.0	0.34	653.63	0.04	87.15
114.0-115.0	0.83	625.53	0.11	83.40	161.0-162.0	0.32	653.95	0.04	87.19
115.0-116.0	0.82	626.35	0.11	83.51	162.0-163.0	0.31	654.26	0.04	87.23
116.0-117.0	0.81	627.16	0.11	83.62	163.0-164.0	0.29	654.55	0.04	87.27
117.0-118.0	0.81	627.97	0.11	83.73	164.0-165.0	0.27	654.82	0.04	87.31
118.0-119.0	0.80	628.77	0.11	83.84	165.0-166.0	0.26	655.07	0.03	87.34
119.0-120.0	0.80	629.57	0.11	83.94	166.0-167.0	0.24	655.31	0.03	87.38
120.0-121.0	0.79	630.36	0.11	84.05	167.0-168.0	0.22	655.54	0.03	87.40
121.0-122.0	0.78	631.14	0.10	84.15	168.0-169.0	0.20	655.74	0.03	87.43
122.0-123.0	0.77	631.91	0.10	84.25	169.0-170.0	0.19	655.93	0.02	87.46
123.0-124.0	0.76	632.67	0.10	84.36	170.0-171.0	0.17	656.10	0.02	87.48
124.0-125.0	0.75	633.42	0.10	84.46	171.0-172.0	0.15	656.25	0.02	87.50
125.0-126.0	0.75	634.17	0.10	84.56	172.0-173.0	0.14	656.38	0.02	87.52
126.0-127.0	0.74	634.91	0.10	84.65	173.0-174.0	0.12	656.50	0.02	87.53
127.0-128.0	0.73	635.63	0.10	84.75	174.0-175.0	0.10	656.60	0.01	87.55
128.0-129.0	0.72	636.35	0.10	84.85	175.0-176.0	0.08	656.68	0.01	87.56
129.0-130.0	0.71	637.06	0.09	84.94	176.0-177.0	0.06	656.75	0.01	87.57
130.0-131.0	0.70	637.77	0.09	85.04	177.0-178.0	0.05	656.79	0.01	87.57
131.0-132.0	0.69	638.46	0.09	85.13	178.0-179.0	0.03	656.82	0.00	87.58
132.0-133.0	0.68	639.15	0.09	85.22	179.0-180.0	0.01	656.83	0.00	87.58
133.0-134.0	0.67	639.82	0.09	85.31					
134.0-135.0	0.66	640.48	0.09	85.40					
135.0-136.0	0.65	641.13	0.09	85.48					
136.0-137.0	0.64	641.78	0.09	85.57					
137.0-138.0	0.63	642.41	0.08	85.65					
138.0-139.0	0.62	643.03	0.08	85.74					
139.0-140.0	0.61	643.64	0.08	85.82					
140.0-141.0	0.60	644.24	0.08	85.90					

-
-
-

IES Indoor Report

Photometric Filename:AD10681(D)(D5)-12W-3500K-RA90-60D-WH.IES

Rectangle ISO Lighting Intensity Diagram

Lum. Name: AD10681(D)(D5)-12W-3500K-RA90-60D-WH	Lum. Catalog: 天花灯	Test ID:
Lamp Name: CLU701-1002C4-353H5K2	Lamp Catalog: COB	Test Lab: Test
Manufacture:	Test Machine:GON-2000	Test Date: 2022/06/05

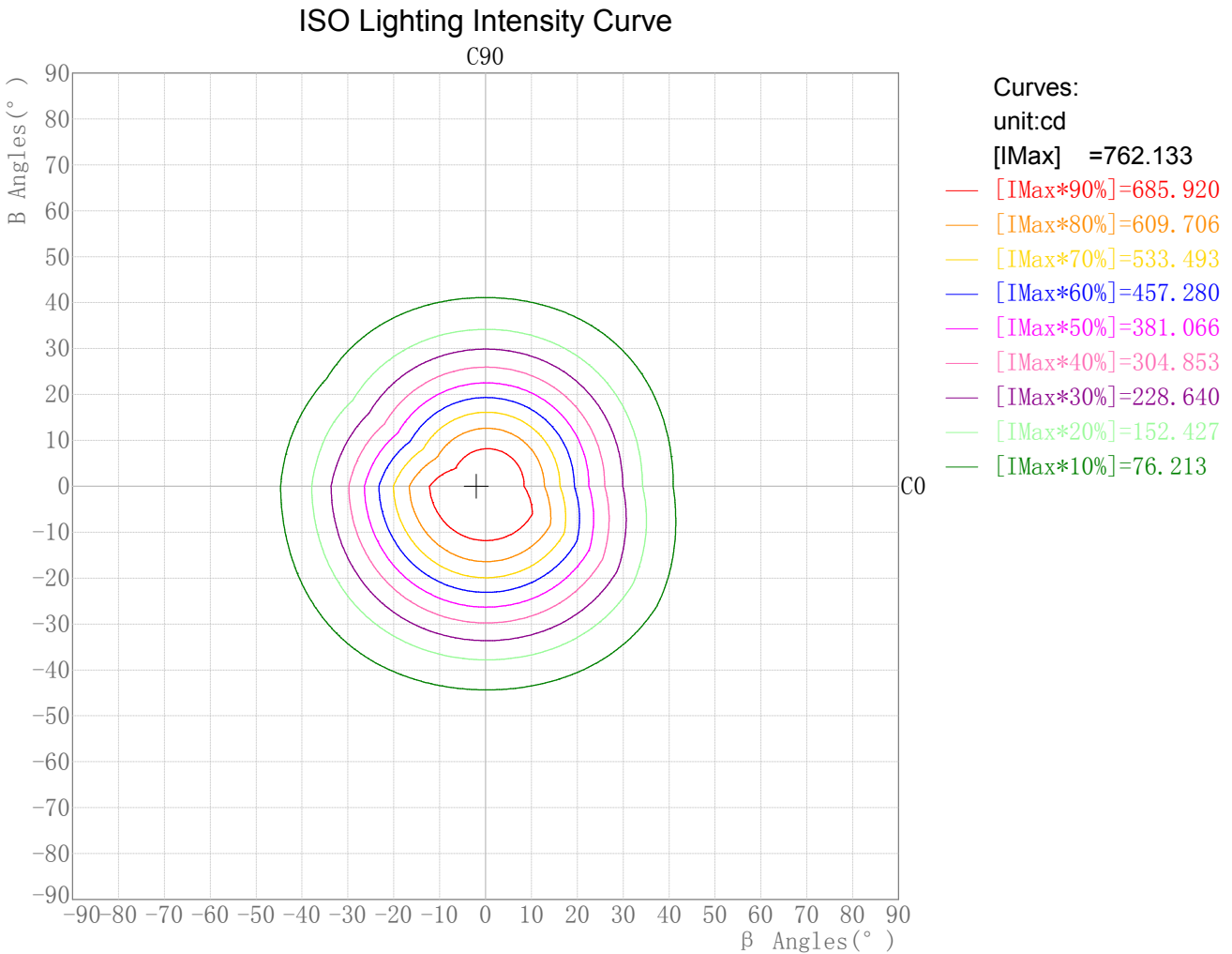

Maximum Light Intensity(cd): 762.13
Maximum Cand.@Angle: H=-2.0°,V=0.0°

IES Indoor Report

Photometric Filename:AD10681(D)(D5)-12W-3500K-RA90-60D-WH.IES

Round ISO Lighting Intensity Diagram

Lum. Name: AD10681(D)(D5)-12W-3500K-RA90-60D-WH	Lum. Catalog: 天花灯	Test ID:
Lamp Name: CLU701-1002C4-353H5K2	Lamp Catalog: COB	Test Lab: Test
Manufacture:	Test Machine:GON-2000	Test Date: 2022/06/05

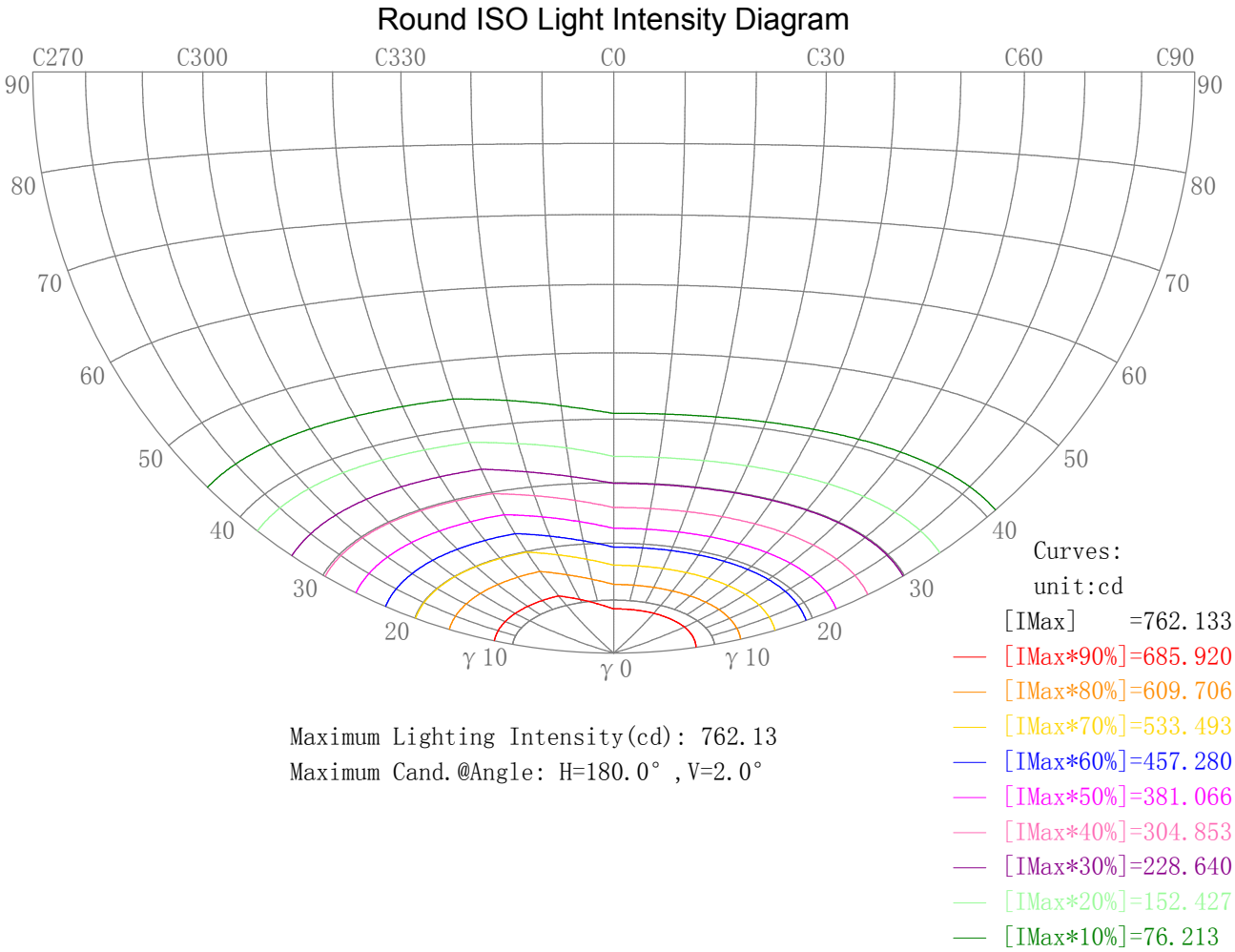

IES Indoor Report

Photometric Filename: AD10681(D)(D5)-12W-3500K-RA90-60D-WH.IES

Plane ISO-Illuminance Diagram

Lum. Name: AD10681(D)(D5)-12W-3500K-RA90-60D-WH	Lum. Catalog: 天花灯	Test ID:
Lamp Name: CLU701-1002C4-353H5K2	Lamp Catalog: COB	Test Lab: Test
Manufacture:	Test Machine: GON-2000	Test Date: 2022/06/05

Plane ISO-Illuminance Curve

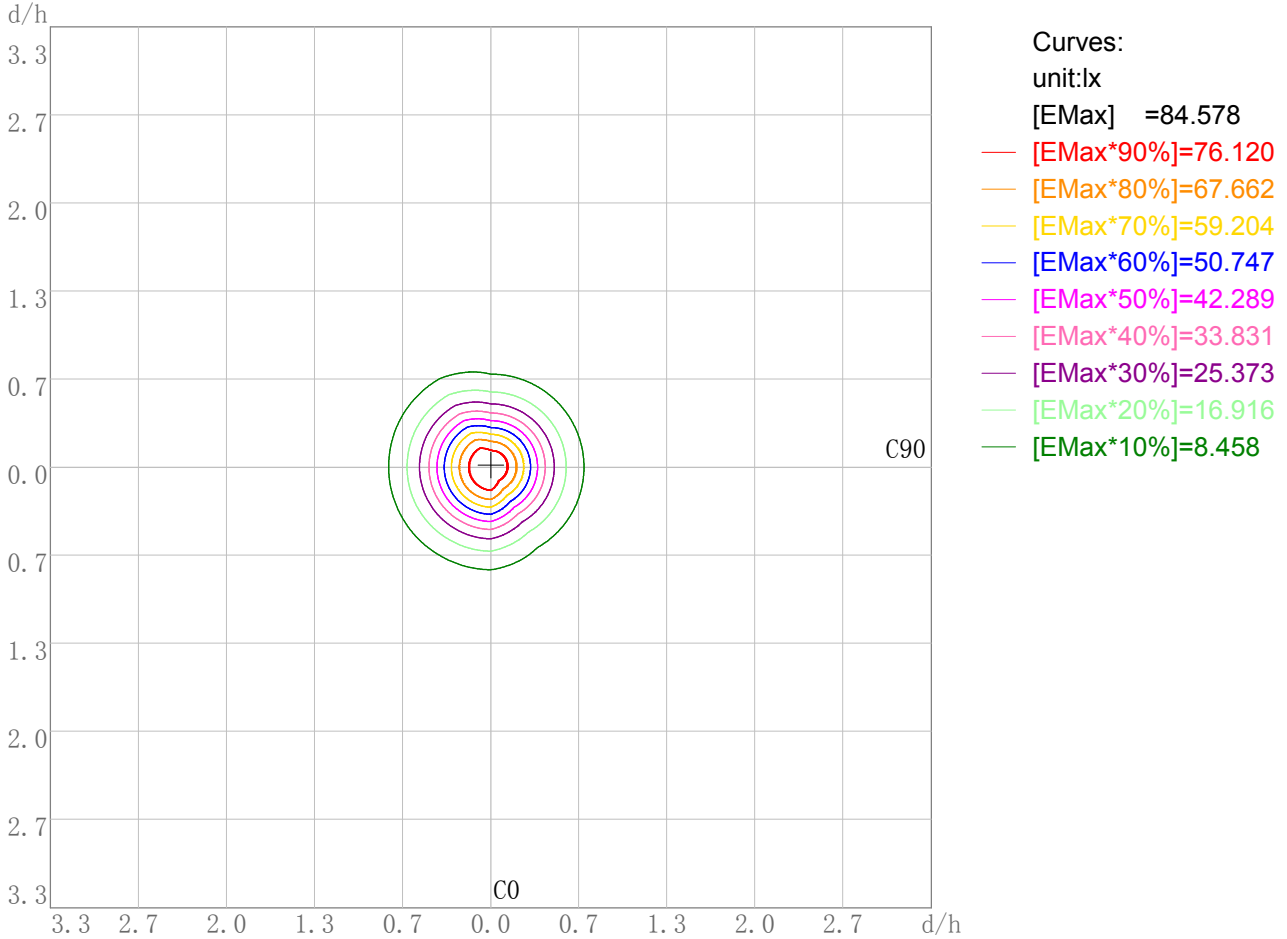

Working Plane Luminaire Mounting Height(m): 3.00
 Working Plane Maximum Illuminance(lx): 84.58
 Working Plane Maximum Illuminance Position(d/h):H0.0 V-0.0

IES Indoor Report

Photometric Filename:AD10681(D)(D5)-12W-3500K-RA90-60D-WH.IES

3D Plane ISO Illuminance Diagram

Lum. Name: AD10681(D)(D5)-12W-3500K-RA90-60D-WH	Lum. Catalog: 天花灯	Test ID:
Lamp Name: CLU701-1002C4-353H5K2	Lamp Catalog: COB	Test Lab: Test
Manufacture:	Test Machine:GON-2000	Test Date: 2022/06/05

3D Plane Illuminance Modal

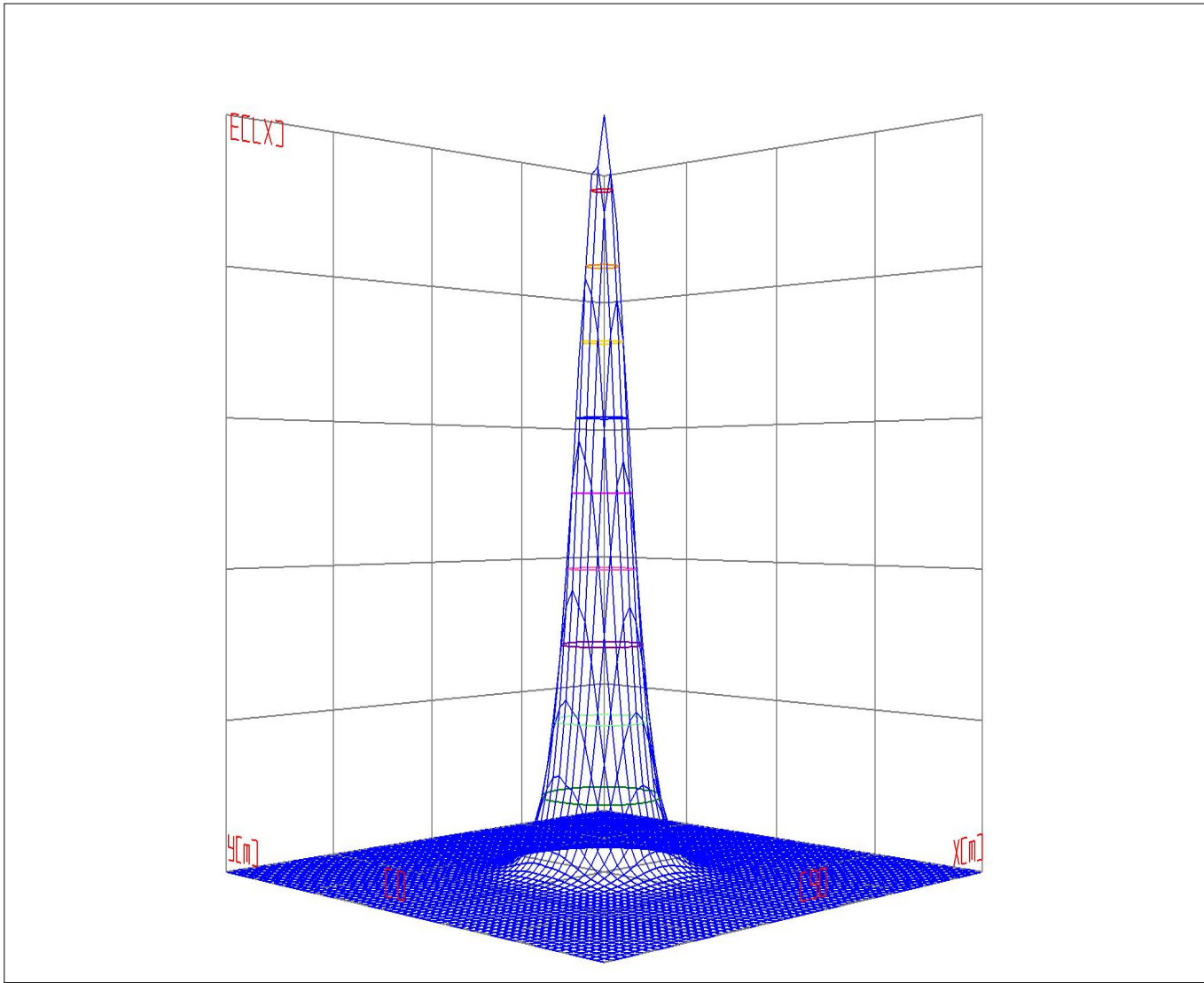

Curves: 3D Model — 90% — 80% — 70% — 60% — 50% — 40% — 30% — 20% — 10% —
View Angles(deg): 0 Height(m): 3.0 Distance(m): 10.0

IES Indoor Report

Photometric Filename:AD10681(D)(D5)-12W-3500K-RA90-60D-WH.IES

Space ISO Illuminance Diagram

Lum. Name: AD10681(D)(D5)-12W-3500K-RA90-60D-WH	Lum. Catalog: 天花灯	Test ID:
Lamp Name: CLU701-1002C4-353H5K2	Lamp Catalog: COB	Test Lab: Test
Manufacture:	Test Machine: GON-2000	Test Date: 2022/06/05

Space ISO Illuminance Curve

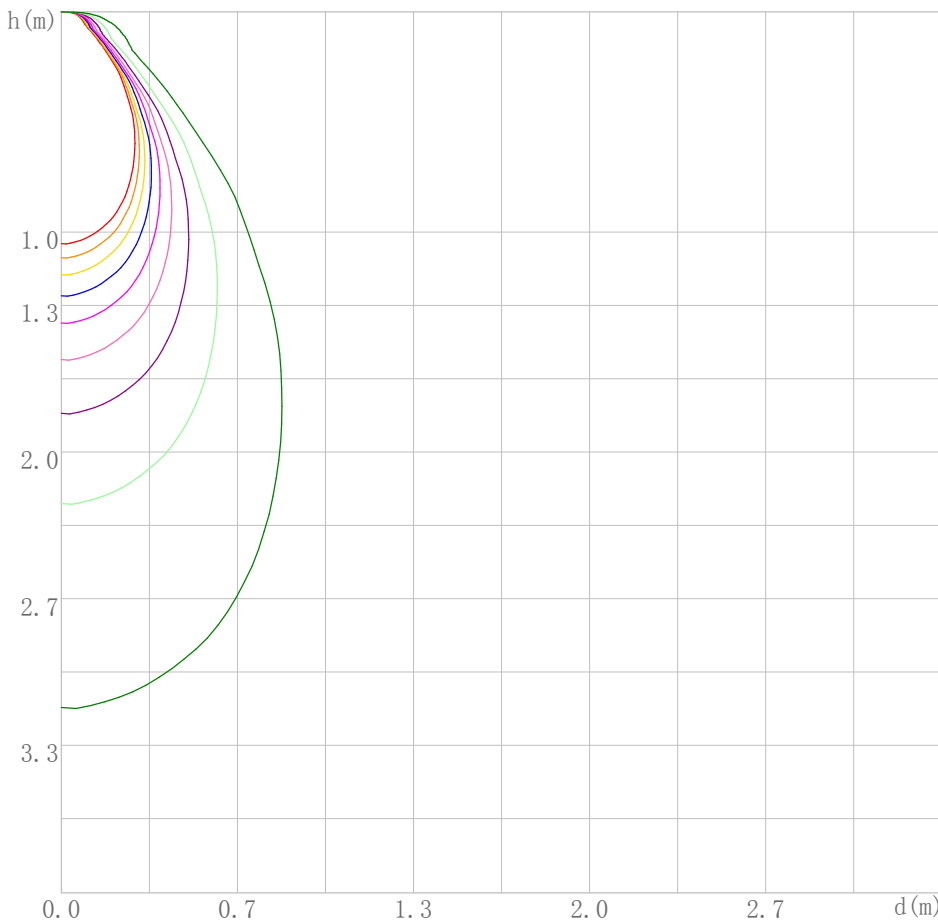

Curves:

[Unit: lx]

[EMax] =755.887

— [EMax*90%]=680.298

— [EMax*80%]=604.709

— [EMax*70%]=529.121

— [EMax*60%]=453.532

— [EMax*50%]=377.943

— [EMax*40%]=302.355

— [EMax*30%]=226.766

— [EMax*20%]=151.177

— [EMax*10%]=75.589

Space Plane Maximum Illuminance and @Angle:755.89lx,1.0deg

Plane Maximum Lighting Intensity and @Angle:756.232cd,0deg

IES Indoor Report

Photometric Filename: AD10681(D)(D5)-12W-3500K-RA90-60D-WH.IES

Illuminance-Distance Diagram

Lum. Name: AD10681(D)(D5)-12W-3500K-RA90-60D-WH	Lum. Catalog: 天花灯	Test ID:
Lamp Name: CLU701-1002C4-353H5K2	Lamp Catalog: COB	Test Lab: Test
Manufacture:	Test Machine: GON-2000	Test Date: 2022/06/05

Illuminance-Distance Curve

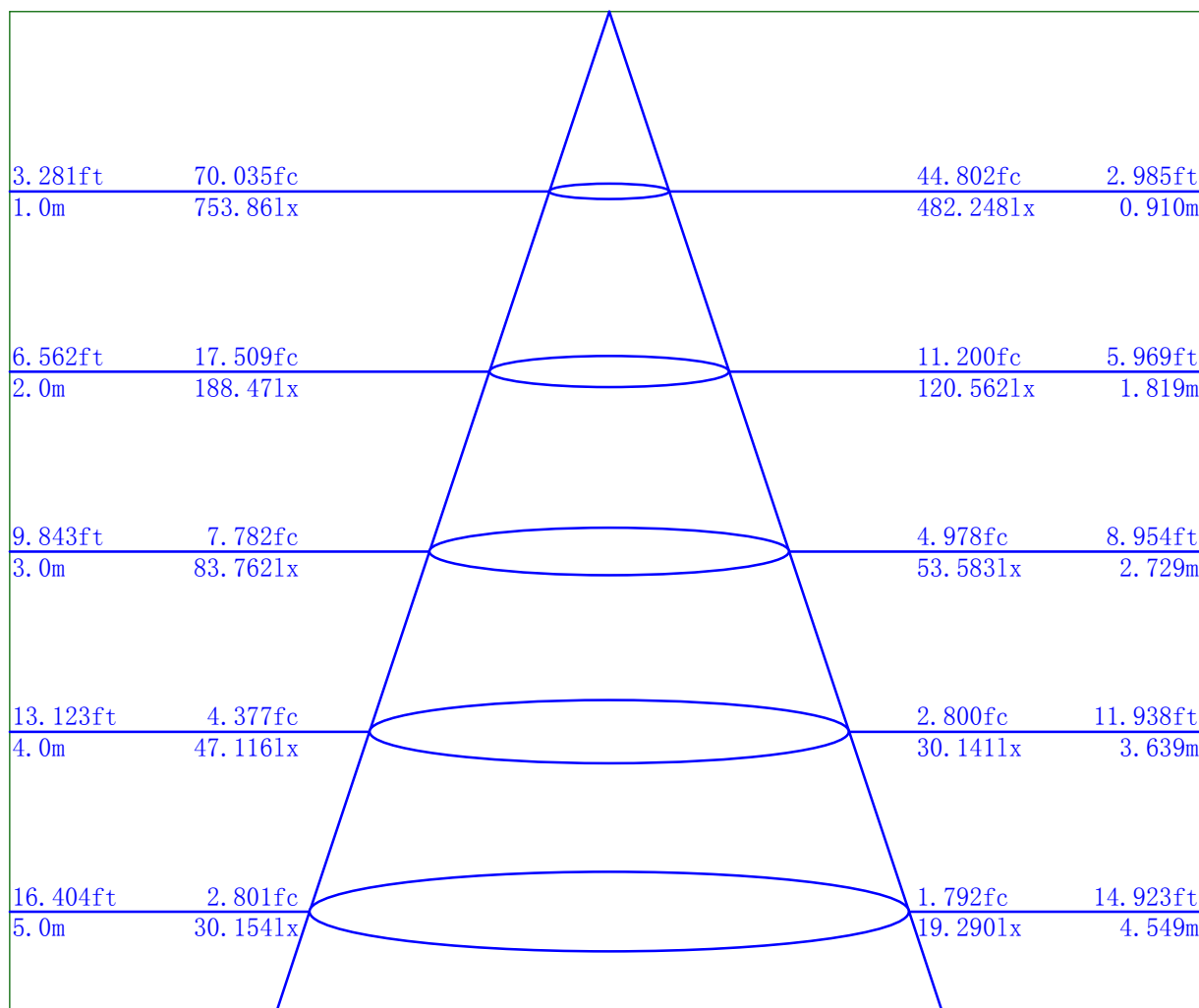

Height

Center E

Average E

Diameter

Beam Angle: 48.9

-
-
-

IES Indoor Report

Photometric Filename:AD10681(D)(D5)-12W-3500K-RA90-60D-WH.IES

Indoor Luminance Limiting Curves

Lum. Name: AD10681(D)(D5)-12W-3500K-RA90-60D-WH	Lum. Catalog: 天花灯	Test ID:
Lamp Name: CLU701-1002C4-353H5K2	Lamp Catalog: COB	Test Lab: Test
Manufacture:	Test Machine:GON-2000	Test Date: 2022/06/05

Glare Grade Table

GI	Quality	Using Illuminance							
		a	b	c	d	e	f	g	h
1.15	A	2000	1000	500	<=300				
1.5	B		2000	1000	500	<=300			
1.85	C			2000	1000	500	<=300		
2.2	D				2000	1000	500	<=300	
2.55	E	a				2000	1000	500	<=300
			b	c	d	e	f	g	h

Luminance Table

Gama(deg)	45	50	55	60	65	70	75	80	85
C0	0	0	0	0	0	0	0	0	0
C90	0	0	0	0	0	0	0	0	0

Luminance Limiting Curve

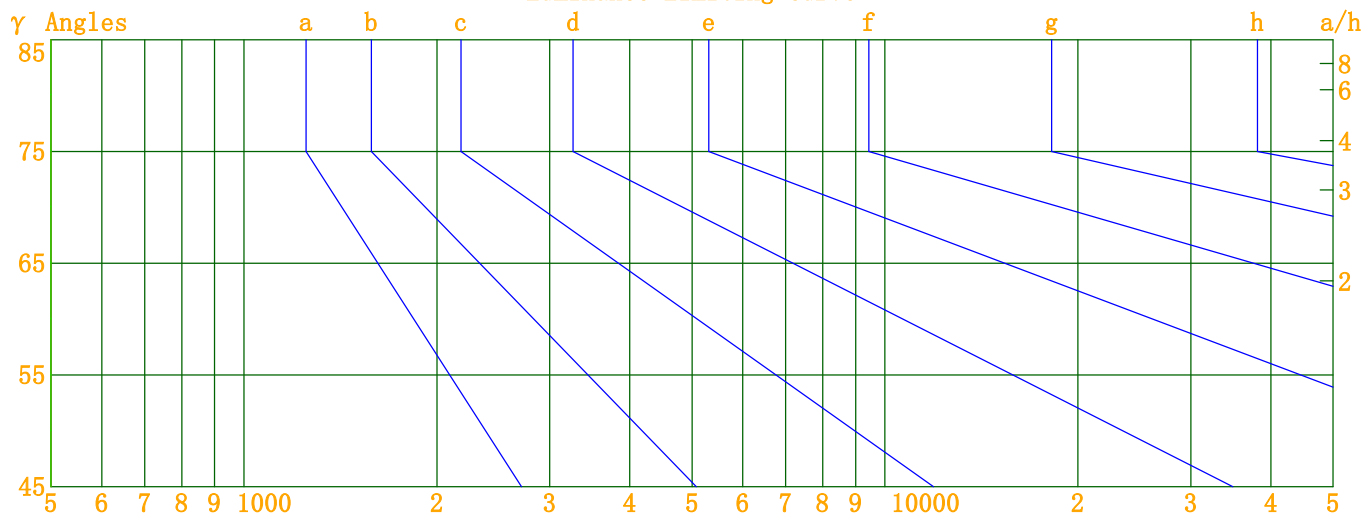

Luminous Size: Length(m)=0.000 Width(m)=0.000 Height(m)=0.000 Area(m^2)=0.000000
 Luminous Type: Without Luminous Side
 Luminous Curves: C0-C180 Color: — C90-C270 Color: —

IES Indoor Report

Photometric Filename: AD10681(D)(D5)-12W-3500K-RA90-60D-WH.IES

Indoor Budgetary Estimate Table

Lum. Name: AD10681(D)(D5)-12W-3500K-RA90-60D-WH	Lum. Catalog: 天花灯	Test ID:
Lamp Name: CLU701-1002C4-353H5K2	Lamp Catalog: COB	Test Lab: Test
Manufacture:	Test Machine: GON-2000	Test Date: 2022/06/05

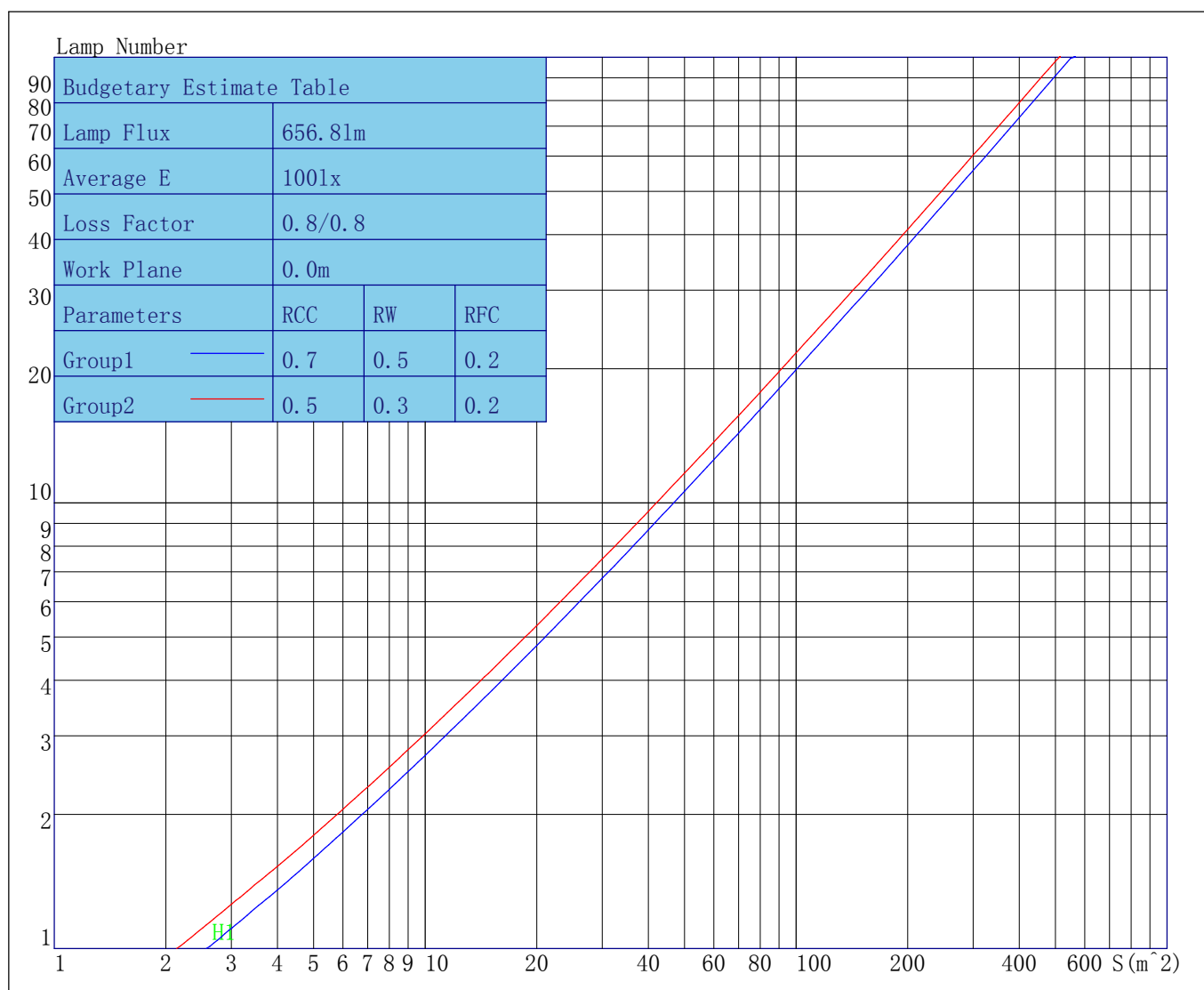

Parameters1: Rhocc = 0.7 Rhow = 0.5 Rhofc = 0.2 LLF = 0.8
 Parameters2: Rhocc = 0.5 Rhow = 0.3 Rhofc = 0.2 LLF = 0.8
 Average Illuminance(lx): 100 Cavity Height: H1(m) = 2

-
-
-

IES Indoor Report

Photometric Filename:AD10681(D)(D5)-12W-3500K-RA90-60D-WH.IES

Indoor Coefficient of Utilization Table

Lum. Name: AD10681(D)(D5)-12W-3500K-RA90-60D-WH	Lum. Catalog: 天花灯	Test ID:
Lamp Name: CLU701-1002C4-353H5K2	Lamp Catalog: COB	Test Lab: Test
Manufacture:	Test Machine:GON-2000	Test Date: 2022/06/05

Coefficients of Utilization - Zonal Cavity Method																		
Coef.	Effective Floor Cavity Reflectance RFC=0.20																	
RhoCC (%)	80				70				50			30			10			0
RhoW (%)	70	50	30	10	70	50	30	10	50	30	10	50	30	10	50	30	10	0
RCR	Coefficient of Utilization (%)																	
0	103	103	103	103	99	99	99	99	93	93	93	88	88	88	83	83	83	80
1	97	94	91	89	94	91	89	87	86	84	83	82	80	79	78	76	75	73
2	91	86	82	79	88	84	80	77	80	77	75	76	74	72	73	71	69	67
3	86	80	75	71	84	78	74	70	75	71	68	71	68	66	69	66	64	62
4	81	74	69	65	79	73	68	64	70	66	62	67	64	61	65	62	59	58
5	77	69	63	59	75	68	63	59	65	61	58	63	59	56	61	58	55	54
6	73	64	59	55	71	63	58	54	61	57	53	59	55	52	58	54	52	50
7	69	60	55	51	67	59	54	51	58	53	50	56	52	49	54	51	48	47
8	66	57	51	48	64	56	51	47	54	50	47	53	49	46	52	48	45	44
9	62	54	48	45	61	53	48	44	51	47	44	50	46	43	49	45	43	41
10	59	51	45	42	58	50	45	42	49	44	41	48	44	41	47	43	40	39

-
-
-

IES Indoor Report

Photometric Filename:AD10681(D)(D5)-12W-3500K-RA90-60D-WH.IES

Unified Glare Rating Table

Lum. Name: AD10681 (D) (D5)-12W-3500K-RA90-60D-WH	Lum. Catalog: 天花灯	Test ID:
Lamp Name: CLU701-1002C4-353H5K2	Lamp Catalog: COB	Test Lab: Test
Manufacture:	Test Machine:GON-2000	Test Date: 2022/06/05

Unified Glare Rating Table

Ceiling RCC	0.70	0.70	0.50	0.50	0.30	0.70	0.70	0.50	0.50	0.30
Wall RW	0.50	0.30	0.50	0.30	0.30	0.50	0.30	0.50	0.30	0.30
Floor RFC	0.20	0.20	0.20	0.20	0.20	0.20	0.20	0.20	0.20	0.20
Room Size	Vewed crosswise					Vewed endwise				
X=2H Y=2H	-2.2	-1.4	-1.6	-0.9	-0.4	-2.2	-1.4	-1.6	-0.9	-0.4
Y=3H	-2.3	-1.7	-1.8	-1.2	-0.6	-2.3	-1.7	-1.8	-1.2	-0.6
Y=4H	-2.4	-1.8	-1.9	-1.3	-0.7	-2.4	-1.8	-1.9	-1.3	-0.7
Y=6H	-2.5	-2.0	-2.0	-1.5	-0.9	-2.5	-2.0	-2.0	-1.5	-0.9
Y=8H	-2.6	-2.1	-2.0	-1.6	-0.9	-2.6	-2.1	-2.0	-1.6	-0.9
Y=12H	-2.7	-2.2	-2.1	-1.7	-1.0	-2.7	-2.2	-2.1	-1.7	-1.0
X=4H Y=2H	-2.4	-1.8	-1.9	-1.3	-0.7	-2.4	-1.8	-1.9	-1.3	-0.7
Y=3H	-2.6	-2.2	-2.0	-1.6	-1.0	-2.6	-2.2	-2.0	-1.6	-1.0
Y=4H	-2.7	-2.4	-2.1	-1.8	-1.1	-2.7	-2.4	-2.1	-1.8	-1.1
Y=6H	-2.8	-2.5	-2.2	-1.9	-1.3	-2.8	-2.5	-2.2	-1.9	-1.3
Y=8H	-2.9	-2.6	-2.3	-2.1	-1.4	-2.9	-2.6	-2.3	-2.1	-1.4
Y=12H	-3.0	-2.8	-2.3	-2.1	-1.5	-3.0	-2.8	-2.3	-2.1	-1.5
X=8H Y=4H	-2.9	-2.6	-2.3	-2.1	-1.4	-2.9	-2.6	-2.3	-2.1	-1.4
Y=6H	-3.0	-2.9	-2.3	-2.2	-1.5	-3.0	-2.9	-2.3	-2.2	-1.5
Y=8H	-3.0	-3.0	-2.4	-2.3	-1.6	-3.0	-3.0	-2.4	-2.3	-1.6
Y=12H	-3.1	-3.1	-2.4	-2.4	-1.6	-3.1	-3.1	-2.4	-2.4	-1.6
X=12H Y=4H	-3.0	-2.8	-2.3	-2.1	-1.5	-3.0	-2.8	-2.3	-2.1	-1.5
Y=6H	-3.1	-3.0	-2.4	-2.3	-1.6	-3.1	-3.0	-2.4	-2.3	-1.6
Y=8H	-3.1	-3.1	-2.4	-2.4	-1.6	-3.1	-3.1	-2.4	-2.4	-1.6
Variations with the objverer position at spacings										
S=1.0H	0.0/0.0					0.0/0.0				
S=1.5H	0.0/0.0					0.0/0.0				
S=2.0H	0.0/0.0					0.0/0.0				
Reduced UGR Table:										
Nordic Standard Table:	BKO					BKO				
Correction Value	0.0					0.0				

o the CIE Pub. 117, data has been corrected, refers to the lamp's lumens 8.2flm.

-
-
-

IES Indoor Report

Photometric Filename:AD10681(D)(D5)-12W-3500K-RA90-60D-WH.IES

Candela Tabulation

V/H	C0.0	C30.0	C60.0	C90.0	C120.0	C150.0	C180.0	C210.0	C240.0	C270.0	C300.0	C330.0
γ 0.0	753.86	753.86	753.86	753.86	753.86	753.86	753.86	753.86	753.86	753.86	753.86	753.86
γ 1.0	756.23	754.20	752.16	749.24	746.77	744.97	761.55	758.94	756.95	754.59	752.61	750.84
γ 2.0	751.33	749.53	747.47	744.80	741.95	739.66	762.13	759.17	757.30	755.07	753.39	751.75
γ 3.0	744.95	743.56	741.63	738.91	735.89	733.22	761.17	758.00	756.35	754.24	752.59	751.32
γ 4.0	737.62	736.24	734.34	731.70	728.38	725.89	758.84	755.30	753.78	751.84	750.65	749.39
γ 5.0	728.50	727.36	725.75	722.90	719.52	716.69	755.02	751.22	749.88	748.09	747.13	746.17
γ 6.0	717.99	717.21	715.62	712.69	709.11	706.06	749.52	745.73	744.28	743.15	742.44	741.36
γ 7.0	705.53	705.59	704.25	701.11	697.51	694.00	742.74	738.92	737.71	736.80	736.30	735.48
γ 8.0	691.90	692.44	691.17	688.16	684.37	680.61	734.78	730.80	729.60	729.00	728.69	727.92
γ 9.0	676.74	677.86	676.91	673.85	670.05	665.79	725.30	721.25	720.17	719.87	719.85	719.25
γ 10.0	662.27	661.87	660.97	658.32	654.48	650.22	714.75	710.13	709.21	709.16	709.37	709.11
γ 11.0	645.91	644.37	643.78	640.97	637.32	633.20	702.57	697.78	697.28	697.14	697.30	697.10
γ 12.0	626.66	625.46	625.14	622.17	618.65	614.59	689.00	684.22	683.43	683.74	683.97	683.86
γ 13.0	606.09	605.36	604.97	602.39	598.61	594.77	673.90	669.17	668.48	669.16	669.26	669.32
γ 14.0	584.22	583.88	583.70	581.20	577.43	573.72	657.78	652.90	652.30	653.31	653.47	653.59
γ 15.0	561.50	561.32	561.35	558.80	555.45	551.23	640.53	635.55	634.99	636.25	636.69	636.39
γ 16.0	538.52	538.34	538.98	536.32	533.08	528.78	622.23	616.98	616.53	617.93	618.53	617.86
γ 17.0	514.61	514.88	515.46	513.07	509.98	505.51	602.12	596.95	596.39	598.43	598.57	598.25
γ 18.0	489.78	490.93	491.23	489.32	486.38	481.59	580.84	575.63	575.35	577.22	577.39	576.88
γ 19.0	465.57	466.63	467.02	465.36	462.35	457.88	558.41	553.17	553.28	554.86	555.37	553.96
γ 20.0	440.84	442.12	442.65	440.86	438.19	433.74	535.01	529.59	530.05	531.71	532.48	530.97
γ 21.0	416.85	417.89	418.52	416.86	414.37	410.08	511.41	505.71	506.23	508.11	508.95	507.36
γ 22.0	393.20	394.11	394.66	392.94	390.80	386.89	487.01	481.61	482.15	483.95	484.83	483.55
γ 23.0	369.99	370.52	371.00	369.65	367.40	363.53	462.93	457.32	457.92	459.81	461.11	459.76
γ 24.0	347.16	347.61	348.18	346.70	344.81	341.14	438.48	433.23	433.94	435.95	437.14	435.58
γ 25.0	325.49	325.67	326.02	324.72	322.90	319.24	414.46	409.38	409.93	412.04	413.43	411.78
γ 26.0	304.18	304.25	304.56	303.58	301.71	298.63	390.33	385.71	386.30	388.60	390.14	388.20
γ 27.0	283.87	283.80	283.79	282.79	281.36	278.39	366.84	362.38	363.03	365.55	367.11	365.27
γ 28.0	264.86	264.32	264.22	263.50	261.99	259.65	343.88	339.61	340.60	343.24	344.63	342.76
γ 29.0	245.71	245.45	245.56	244.53	243.33	241.29	321.74	317.45	318.74	321.31	322.75	321.22
γ 30.0	226.75	226.74	226.99	226.17	225.16	222.55	300.18	296.35	297.85	300.03	301.72	299.82
γ 31.0	207.49	208.14	208.21	207.86	207.03	204.30	279.56	276.18	277.66	279.70	281.39	279.89
γ 32.0	188.45	189.74	189.95	189.16	188.84	185.44	259.95	256.70	258.20	260.09	261.98	260.56
γ 33.0	169.78	171.41	170.97	170.55	170.63	167.43	240.88	237.44	238.82	240.74	242.94	241.79
γ 34.0	155.02	155.27	155.29	154.58	154.26	152.60	222.20	218.22	219.25	221.38	223.74	222.66
γ 35.0	141.79	141.90	141.71	141.32	140.91	139.57	203.47	199.12	199.87	202.12	204.40	203.55
γ 36.0	130.02	129.88	129.74	129.35	128.93	128.10	184.41	180.15	180.49	182.49	185.21	184.34
γ 37.0	119.04	118.94	118.65	118.40	118.01	117.28	165.98	162.44	162.83	164.39	166.82	165.56
γ 38.0	109.14	108.84	108.84	108.24	108.10	107.27	150.51	147.37	147.87	149.59	151.44	150.53
γ 39.0	97.69	98.49	98.70	98.16	98.51	97.49	137.33	134.35	134.62	136.37	138.00	137.32
γ 40.0	86.30	87.32	88.05	87.70	87.96	86.87	125.15	122.47	122.56	124.46	125.60	125.47
γ 41.0	75.02	76.45	76.89	77.10	77.42	76.04	113.92	111.71	111.83	113.29	114.62	114.32
γ 42.0	65.29	66.81	67.25	67.26	67.51	66.27	103.87	101.57	101.76	102.88	104.19	103.95
γ 43.0	57.22	58.69	58.93	58.99	59.18	58.06	94.34	91.12	90.66	91.56	93.03	93.09
γ 44.0	50.52	51.93	52.22	52.10	52.13	51.19	83.52	80.12	79.27	80.01	81.13	81.24
γ 45.0	45.24	46.32	46.46	46.03	45.89	45.46	72.64	69.57	68.59	69.25	70.04	70.00
γ 46.0	40.17	41.52	41.58	41.13	41.07	40.56	62.68	59.98	59.15	59.71	60.26	60.25

-
-
-

IES Indoor Report

Photometric Filename:AD10681(D)(D5)-12W-3500K-RA90-60D-WH.IES

Candela Tabulation - (Cont.)

V/H	C0.0	C30.0	C60.0	C90.0	C120.0	C150.0	C180.0	C210.0	C240.0	C270.0	C300.0	C330.0
γ 47.0	36.32	37.26	37.53	36.87	36.88	36.32	54.16	51.68	51.01	51.55	51.90	51.74
γ 48.0	32.60	33.44	33.96	33.17	33.22	32.72	47.01	45.06	44.39	44.87	45.01	44.90
γ 49.0	29.44	30.23	30.34	29.89	29.88	29.35	40.91	39.44	38.69	39.13	39.49	39.26
γ 50.0	26.46	27.45	27.87	26.95	26.88	26.44	36.18	34.84	34.36	34.38	34.54	34.35
γ 51.0	24.05	24.69	24.85	24.33	23.98	23.35	32.16	30.85	30.46	30.08	30.32	30.19
γ 52.0	21.49	22.32	22.31	22.00	21.51	21.09	28.25	27.00	26.57	26.43	26.45	26.87
γ 53.0	19.36	20.09	19.63	19.49	19.29	18.64	24.85	23.81	23.76	23.33	23.33	23.45
γ 54.0	17.62	17.90	17.58	17.47	17.48	17.04	21.85	21.17	20.86	20.64	20.58	20.40
γ 55.0	16.27	16.32	15.90	15.78	15.79	15.49	19.36	18.59	18.29	18.01	18.14	17.94
γ 56.0	15.25	15.16	15.03	14.68	14.40	14.23	16.93	16.25	15.77	15.53	15.90	15.68
γ 57.0	14.17	14.31	13.89	13.67	13.67	13.56	14.65	14.27	13.60	13.51	13.76	13.60
γ 58.0	13.97	13.99	13.48	13.36	13.20	13.11	12.51	12.32	11.97	11.93	11.86	11.95
γ 59.0	13.66	13.66	13.17	13.10	12.92	12.76	11.26	10.75	10.72	10.52	10.45	10.72
γ 60.0	13.29	13.36	12.87	12.82	12.85	12.43	10.31	9.69	9.53	9.55	9.43	9.55
γ 61.0	13.15	13.26	12.60	12.56	12.58	12.27	9.57	8.95	8.91	8.99	8.84	8.86
γ 62.0	13.01	13.07	12.69	12.47	12.30	12.39	9.10	8.49	8.63	8.48	8.45	8.63
γ 63.0	12.99	12.77	12.64	12.34	12.08	11.80	8.71	8.35	8.39	8.41	8.30	8.32
γ 64.0	12.62	12.68	12.22	12.20	12.16	11.93	8.62	8.45	8.19	8.17	8.22	8.06
γ 65.0	12.63	12.76	12.06	11.91	12.13	11.84	8.27	8.38	8.10	7.94	8.28	7.86
γ 66.0	12.20	12.56	11.97	11.81	11.80	11.69	8.64	8.21	8.07	7.74	8.06	7.93
γ 67.0	12.15	12.27	11.86	11.63	11.80	11.65	8.41	8.14	8.06	7.68	8.06	7.93
γ 68.0	11.96	12.08	11.81	11.58	11.61	11.36	8.24	7.98	7.88	7.61	7.90	7.75
γ 69.0	11.87	11.87	11.30	11.45	11.39	11.21	8.23	7.80	7.76	7.55	7.68	7.93
γ 70.0	11.75	11.85	11.53	11.34	11.30	11.03	8.10	7.72	7.61	7.35	7.64	7.78
γ 71.0	11.53	11.81	11.40	11.36	11.14	11.05	8.22	7.75	7.76	7.27	7.67	7.81
γ 72.0	11.64	11.60	11.10	11.28	10.97	10.80	7.97	7.63	7.70	7.51	7.58	7.71
γ 73.0	11.36	11.39	11.22	11.02	10.97	10.73	7.92	7.58	7.76	7.43	7.55	7.47
γ 74.0	11.41	11.35	11.05	10.89	10.85	10.51	8.01	7.65	7.61	7.45	7.75	7.48
γ 75.0	11.32	11.32	10.73	10.74	10.76	10.40	8.10	7.58	7.67	7.41	7.95	7.46
γ 76.0	10.81	11.03	10.67	10.65	10.68	10.23	7.87	7.65	7.74	7.55	7.75	7.43
γ 77.0	10.82	10.93	10.64	10.64	10.59	10.34	7.64	7.60	7.59	7.61	7.63	7.34
γ 78.0	10.83	10.99	10.50	10.39	10.49	10.15	7.81	7.53	7.82	7.53	7.61	7.17
γ 79.0	10.84	10.63	10.41	10.14	10.29	10.01	7.74	7.60	7.46	7.67	7.62	6.97
γ 80.0	10.79	10.22	10.38	10.32	10.07	9.95	7.79	7.55	7.72	7.53	7.39	7.20
γ 81.0	10.73	10.20	10.08	10.23	10.09	10.05	7.86	7.53	7.55	7.32	7.27	7.16
γ 82.0	10.60	10.04	10.07	10.02	9.90	9.89	7.71	7.55	7.51	7.38	7.38	7.38
γ 83.0	10.49	10.04	9.83	9.91	10.01	9.75	7.80	7.49	7.45	7.62	7.43	7.34
γ 84.0	10.20	10.21	9.71	10.04	9.92	9.73	7.94	7.47	7.47	7.56	7.29	7.33
γ 85.0	10.18	10.17	9.77	9.82	9.94	9.37	7.82	7.46	7.59	7.52	7.38	7.20
γ 86.0	10.28	9.98	9.84	9.67	9.73	9.53	7.77	7.44	7.57	7.53	7.49	7.14
γ 87.0	10.03	9.93	9.96	9.64	9.64	9.44	7.81	7.54	7.95	7.48	7.31	7.08
γ 88.0	10.09	9.97	9.93	9.49	9.59	9.29	7.89	7.68	8.03	7.57	7.29	7.20
γ 89.0	9.80	9.90	10.06	9.60	9.41	9.38	7.68	7.61	7.80	7.49	7.26	7.11
γ 90.0	10.05	9.89	9.87	9.50	9.31	9.40	7.72	7.50	7.73	7.45	7.43	7.20
γ 91.0	10.22	9.88	9.78	9.50	9.14	9.10	7.76	7.55	7.91	7.55	7.55	7.47
γ 92.0	9.51	9.78	9.64	9.14	9.13	9.15	7.93	7.70	7.84	7.56	7.55	7.29
γ 93.0	9.61	9.78	9.76	9.02	9.34	9.19	7.82	7.76	7.81	7.32	7.41	7.45

-
-
-

IES Indoor Report

Photometric Filename:AD10681(D)(D5)-12W-3500K-RA90-60D-WH.IES

Candela Tabulation - (Cont.)

V/H	C0.0	C30.0	C60.0	C90.0	C120.0	C150.0	C180.0	C210.0	C240.0	C270.0	C300.0	C330.0
γ 94.0	9.77	10.00	9.66	9.15	9.24	8.97	7.71	7.59	7.78	7.17	7.46	7.31
γ 95.0	9.74	9.89	9.61	9.17	9.07	8.85	7.62	7.55	7.86	7.53	7.48	7.23
γ 96.0	9.70	9.67	9.64	9.06	9.16	8.69	7.80	7.63	8.03	7.67	7.61	7.39
γ 97.0	9.58	9.62	9.57	9.01	8.97	8.89	7.78	7.71	7.71	7.60	7.51	7.35
γ 98.0	9.70	9.56	9.43	9.04	8.89	8.72	7.92	7.64	7.96	7.59	7.65	7.51
γ 99.0	9.40	9.62	9.30	9.11	8.97	8.62	8.07	7.63	7.72	7.95	7.67	7.31
γ 100.0	9.58	9.62	9.13	9.10	8.73	8.79	7.86	7.73	7.78	7.81	7.91	7.66
γ 101.0	9.58	9.43	9.14	8.96	8.99	8.50	7.79	7.59	8.09	7.66	7.85	7.53
γ 102.0	9.69	9.32	9.22	8.89	8.98	8.60	7.99	7.59	7.78	7.78	7.48	7.61
γ 103.0	9.62	9.37	9.22	8.67	8.79	8.72	7.95	7.72	7.86	7.73	7.35	7.69
γ 104.0	9.59	9.32	8.99	8.79	8.68	8.44	8.04	7.94	8.04	7.77	7.59	7.93
γ 105.0	9.44	9.27	8.88	8.79	8.58	8.50	8.28	8.18	8.05	7.72	7.62	7.74
γ 106.0	9.48	9.23	8.99	8.74	8.57	8.63	8.09	8.10	8.05	7.60	7.62	7.66
γ 107.0	9.05	9.05	8.88	8.59	8.45	8.39	7.98	8.06	8.07	7.65	7.66	7.59
γ 108.0	9.14	9.16	8.97	8.63	8.56	8.17	8.01	8.22	7.87	7.72	7.80	7.47
γ 109.0	9.38	9.28	8.98	8.49	8.51	8.30	8.14	8.09	7.90	7.68	8.07	7.62
γ 110.0	9.35	9.15	8.69	8.27	8.66	8.40	8.05	7.95	7.99	7.65	7.75	7.70
γ 111.0	9.08	9.18	8.71	8.49	8.58	8.56	8.11	8.01	8.18	7.77	7.69	7.81
γ 112.0	9.29	8.98	8.55	8.55	8.27	8.56	7.89	8.11	8.05	7.79	7.88	7.63
γ 113.0	9.02	8.74	8.96	8.52	8.37	8.48	7.98	7.95	8.02	7.95	7.70	7.85
γ 114.0	8.91	8.90	8.49	8.53	8.27	8.43	8.21	7.85	8.17	7.76	7.82	7.92
γ 115.0	8.91	8.84	8.53	8.51	8.16	8.51	7.94	8.14	8.31	7.83	7.87	7.91
γ 116.0	8.89	8.72	8.48	8.41	8.19	8.56	8.09	8.13	8.30	7.83	7.62	7.83
γ 117.0	8.99	8.77	8.66	8.53	8.16	8.51	8.15	8.15	8.09	7.89	7.79	7.70
γ 118.0	9.09	8.82	8.56	8.60	8.33	8.14	8.12	8.23	8.35	8.01	7.90	7.58
γ 119.0	8.77	8.86	8.64	8.62	8.35	8.37	8.09	8.08	8.34	7.82	7.88	7.84
γ 120.0	9.07	8.78	8.76	8.67	8.31	8.18	8.58	8.13	8.56	7.87	7.91	8.19
γ 121.0	8.70	8.82	8.59	8.73	8.11	8.02	8.66	8.04	8.26	7.97	8.01	8.02
γ 122.0	8.83	8.93	8.50	8.61	8.16	8.44	8.46	7.96	8.44	8.03	7.93	8.00
γ 123.0	9.10	8.77	8.60	8.54	8.10	8.35	8.37	7.98	8.29	7.84	7.76	7.88
γ 124.0	9.10	8.83	8.38	8.52	8.06	8.05	8.52	8.18	8.25	8.09	7.98	7.76
γ 125.0	9.03	9.01	8.59	8.30	8.05	8.33	8.69	8.28	8.27	7.97	8.13	7.86
γ 126.0	8.95	8.87	8.59	8.52	8.15	8.57	8.41	8.17	8.41	8.09	8.28	7.79
γ 127.0	8.70	8.81	8.49	8.55	8.14	8.43	8.45	8.13	8.04	8.05	8.22	7.73
γ 128.0	8.81	8.76	8.65	8.66	8.25	8.35	8.54	8.05	8.24	8.22	8.29	7.68
γ 129.0	9.16	8.79	8.72	8.38	8.30	8.53	8.35	8.19	8.10	8.14	8.12	7.83
γ 130.0	9.06	8.87	8.75	8.44	8.36	8.31	8.54	8.29	8.28	8.27	8.10	7.98
γ 131.0	8.94	8.93	8.75	8.65	8.33	8.53	8.38	8.32	8.24	8.15	8.25	8.00
γ 132.0	8.99	8.99	8.65	8.43	8.38	8.76	8.32	8.20	8.43	8.23	8.22	7.94
γ 133.0	8.62	8.99	8.76	8.44	8.31	8.62	8.43	8.12	8.41	8.33	8.11	8.07
γ 134.0	8.75	8.92	8.93	8.53	8.35	8.48	8.59	8.24	8.40	8.15	8.19	7.89
γ 135.0	8.94	8.77	9.12	8.65	8.48	8.71	8.48	8.39	8.08	8.23	8.22	7.79
γ 136.0	8.87	8.81	9.04	8.45	8.60	8.47	8.63	8.43	8.40	8.23	8.28	8.13
γ 137.0	8.81	8.82	8.81	8.37	8.39	8.45	8.45	8.37	8.45	8.12	8.33	7.89
γ 138.0	8.95	8.83	8.85	8.77	8.48	8.61	8.69	8.43	8.39	8.29	8.39	8.15
γ 139.0	8.97	9.06	8.67	8.86	8.65	8.54	8.41	8.45	8.55	8.32	8.33	8.06
γ 140.0	9.06	9.15	8.76	8.77	8.52	8.68	8.84	8.40	8.63	8.25	8.12	8.07

-
-
-

IES Indoor Report

Photometric Filename:AD10681(D)(D5)-12W-3500K-RA90-60D-WH.IES

Candela Tabulation - (Cont.)

V/H	C0.0	C30.0	C60.0	C90.0	C120.0	C150.0	C180.0	C210.0	C240.0	C270.0	C300.0	C330.0
γ 141.0	9.11	9.04	8.84	8.84	8.51	8.70	8.66	8.38	8.48	8.31	8.33	8.11
γ 142.0	8.90	9.01	8.76	8.76	8.79	8.53	8.57	8.48	8.51	8.38	8.55	8.22
γ 143.0	9.03	8.93	8.72	8.80	8.79	8.59	8.70	8.54	8.54	8.41	8.40	8.02
γ 144.0	9.10	8.94	8.73	8.95	8.74	8.62	8.92	8.51	8.42	8.50	8.34	8.05
γ 145.0	9.26	9.14	9.08	9.13	8.71	8.78	8.95	8.68	8.69	8.46	8.54	8.20
γ 146.0	9.28	9.25	8.90	9.14	8.90	8.71	8.88	8.78	8.76	8.48	8.55	8.38
γ 147.0	9.24	9.31	9.04	8.98	8.97	9.08	9.10	8.72	8.62	8.63	8.52	8.26
γ 148.0	9.13	9.31	8.78	9.10	8.78	8.83	8.87	8.69	8.77	8.51	8.65	8.51
γ 149.0	9.18	9.19	8.96	8.99	8.79	8.70	8.87	8.74	8.55	8.47	8.72	8.26
γ 150.0	9.57	9.27	9.13	9.05	9.03	8.74	8.71	8.74	8.85	8.54	8.94	8.17
γ 151.0	9.32	9.42	8.94	9.11	9.07	8.65	8.87	8.73	8.57	8.44	8.86	8.10
γ 152.0	9.48	9.40	9.38	8.88	8.79	8.72	9.10	8.81	8.67	8.62	8.74	8.47
γ 153.0	9.69	9.34	9.38	9.06	8.80	8.59	8.92	8.94	8.73	8.56	8.99	8.47
γ 154.0	9.30	9.35	9.52	9.24	8.91	8.54	8.95	8.88	8.88	8.56	8.98	8.41
γ 155.0	9.35	9.46	9.34	9.26	8.91	8.78	9.12	8.83	9.16	8.63	9.12	8.62
γ 156.0	9.60	9.58	9.47	9.16	8.91	8.77	9.11	8.95	9.10	8.62	9.20	8.46
γ 157.0	9.65	9.65	9.49	9.09	9.21	9.05	9.06	8.98	9.07	8.67	8.81	8.79
γ 158.0	9.49	9.48	9.59	9.10	9.18	8.78	8.95	9.02	9.01	8.70	8.89	8.69
γ 159.0	9.27	9.26	9.31	9.19	9.25	8.70	9.41	9.07	9.20	8.81	9.21	8.98
γ 160.0	9.52	9.36	9.49	9.27	9.25	9.02	9.23	9.08	9.27	8.84	9.08	8.92
γ 161.0	9.53	9.49	9.58	9.19	9.13	8.85	9.21	9.13	9.26	8.91	8.93	8.99
γ 162.0	9.58	9.52	9.64	9.24	9.21	9.07	9.39	9.21	9.21	8.95	9.10	9.24
γ 163.0	9.63	9.31	9.60	9.15	8.99	9.07	9.56	9.31	9.18	9.01	9.24	9.26
γ 164.0	9.58	9.20	9.46	9.13	9.01	8.98	9.51	9.39	9.36	9.12	9.28	8.86
γ 165.0	9.43	9.53	9.55	9.27	9.30	9.14	9.30	9.34	9.59	9.01	9.19	9.16
γ 166.0	9.48	9.76	9.55	9.11	9.32	9.11	9.36	9.30	9.44	9.00	9.40	9.20
γ 167.0	9.79	9.61	9.59	9.18	9.44	9.12	9.53	9.32	9.22	9.21	9.48	9.02
γ 168.0	9.76	9.47	9.41	9.43	9.46	8.97	9.36	9.33	9.40	9.32	9.19	8.98
γ 169.0	9.41	9.57	9.37	9.26	9.38	8.96	9.48	9.35	9.48	9.15	9.22	9.21
γ 170.0	9.52	9.51	9.74	9.07	9.58	8.97	9.65	9.43	9.56	9.24	9.35	9.43
γ 171.0	9.82	9.48	9.67	9.14	9.56	9.11	9.39	9.43	9.40	9.45	9.36	9.21
γ 172.0	9.61	9.53	9.66	9.29	9.53	9.38	9.45	9.32	9.38	9.32	9.26	9.25
γ 173.0	9.50	9.53	9.63	9.50	9.56	9.19	9.61	9.41	9.56	9.17	9.39	9.37
γ 174.0	9.63	9.61	9.64	9.63	9.52	9.42	9.50	9.47	9.39	9.05	9.34	9.43
γ 175.0	9.78	9.64	9.62	9.46	9.49	9.39	9.60	9.39	9.45	8.99	9.46	9.32
γ 176.0	9.42	9.58	9.50	9.42	9.55	9.57	9.40	9.33	9.44	9.13	9.51	9.23
γ 177.0	9.54	9.64	9.46	9.41	9.60	9.34	9.41	9.34	9.69	9.29	9.55	9.35
γ 178.0	9.66	9.61	9.47	9.47	9.53	9.28	9.59	9.49	9.75	9.17	9.53	9.66
γ 179.0	9.73	9.63	9.45	9.36	9.47	9.37	9.53	9.60	9.61	9.39	9.38	9.35
γ 180.0	9.52	9.52	9.52	9.52	9.52	9.52	9.52	9.52	9.52	9.52	9.52	9.52