

IES Indoor Report

Photometric Filename:AD12541 10W 1202C9 3090 ZHT35-24D 250.IES

Indoor Luminaire Photometric Data

Description Information

Luminary Name: AW12541	Lum. Catalog: Down Light	Test ID:
Lamp Name: 1202C9	Lamp Catalog: COB	Test Date: 2023/07/17
Manufacture:	Shld. Ang(°):24	Test Machine:GON-2000
Test Lab: Test	Frequency(Hz):50	Lamp CCT(K): 3000 Ra: 90
Lum. Size(W*L*H):0.066m*0.066m*0.000m	Lum. Area(m ²):0.003	Lum. W(kg): 0.000
Test System: C, γ	Test Step: C=22.5 γ =1.0	Temp. (°C): 25
		Humidity(%): 50.0

Character Parameter

Lamp Speciality Parameter		Luminaire Speciality Parameter	
Rated Flux(lm): 660.000	Luminary Flux(lm): 660.017	Field Angle(10%Imax): 50.7(°)	
Rated Power(W): 10	Luminary Efficiency: 100.00%	Down Lumens&Percent: 645.583lm 97.81%	
Rated Voltage(V): 220	Luminary EER(lm/W): 61.915	Up Lumens&Percent: 14.434lm 2.19%	
Tested Power(W): 10.660	Max. Candela(cd): 2326.426	S/MH: C0_a180=0.471 C90_270=0.464	
Lamps' Inside: 1	Max Cand@Ang.(°): C=0.0 γ =1.0	CIE Type: Semi-Direct	
Tested Electrics(V, A, pf):220.6, 0.087, 0.551	Beam Angle(50%Imax): 27.8(°)	ErP Φ use(90°): 621.811lm	
Lamp Size(W*L*H):0.066m*0.066m*0.000m	Left=-13.1°, Right=14.7°	IRF(%): 728.753	

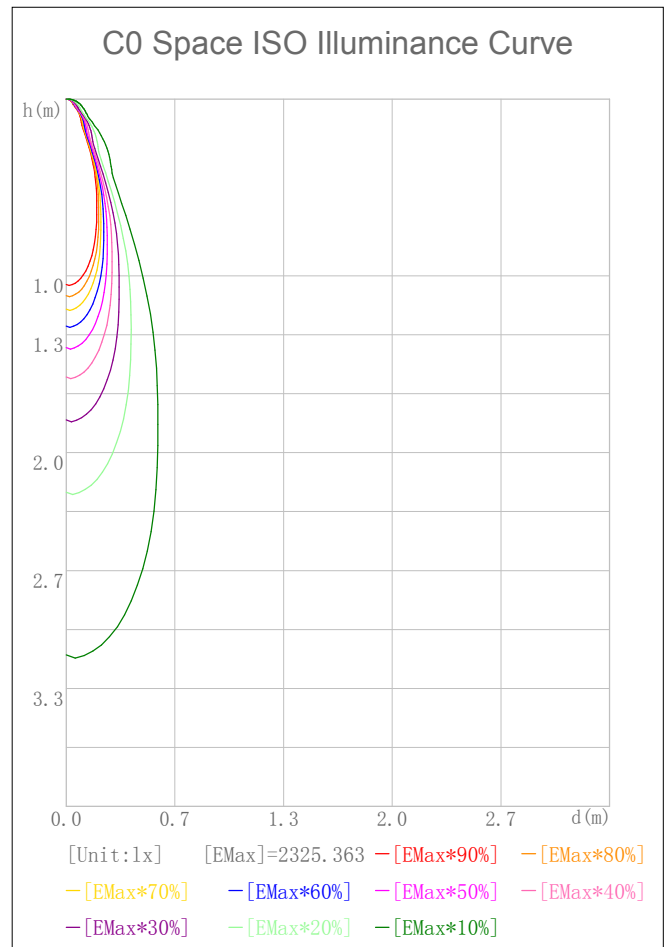
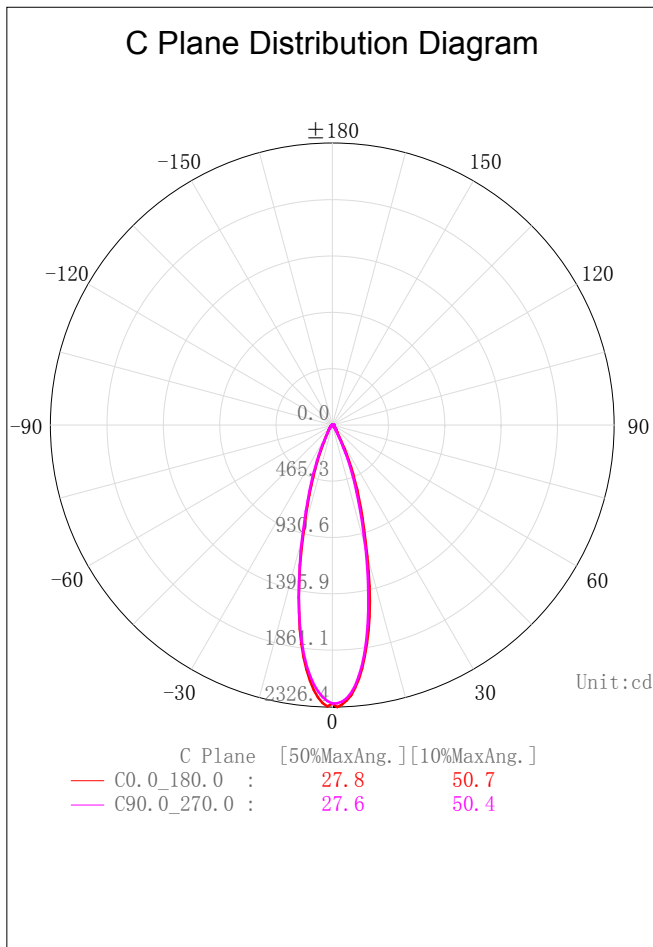

IES Indoor Report

Photometric Filename:AD12541 10W 1202C9 3090 ZHT35-24D 250.IES

2D Plane Light Intensity Distribution Curve

Lum. Name: AW12541	Lum. Catalog: Down Light	Test ID:
Lamp Name: 1202C9	Lamp Catalog: COB	Test Lab: Test
Manufacture:	Test Machine:GON-2000	Test Date: 2023/07/17

C Plane Distribution Diagram

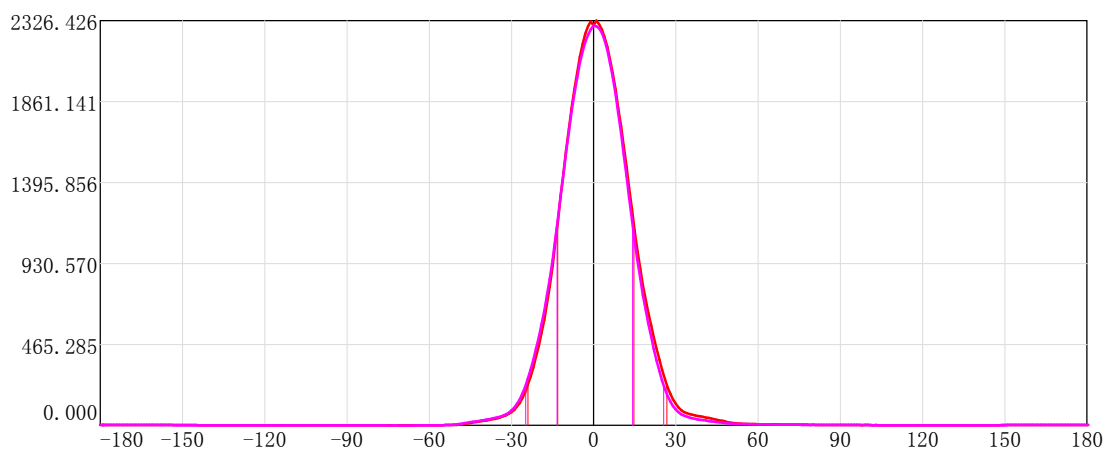
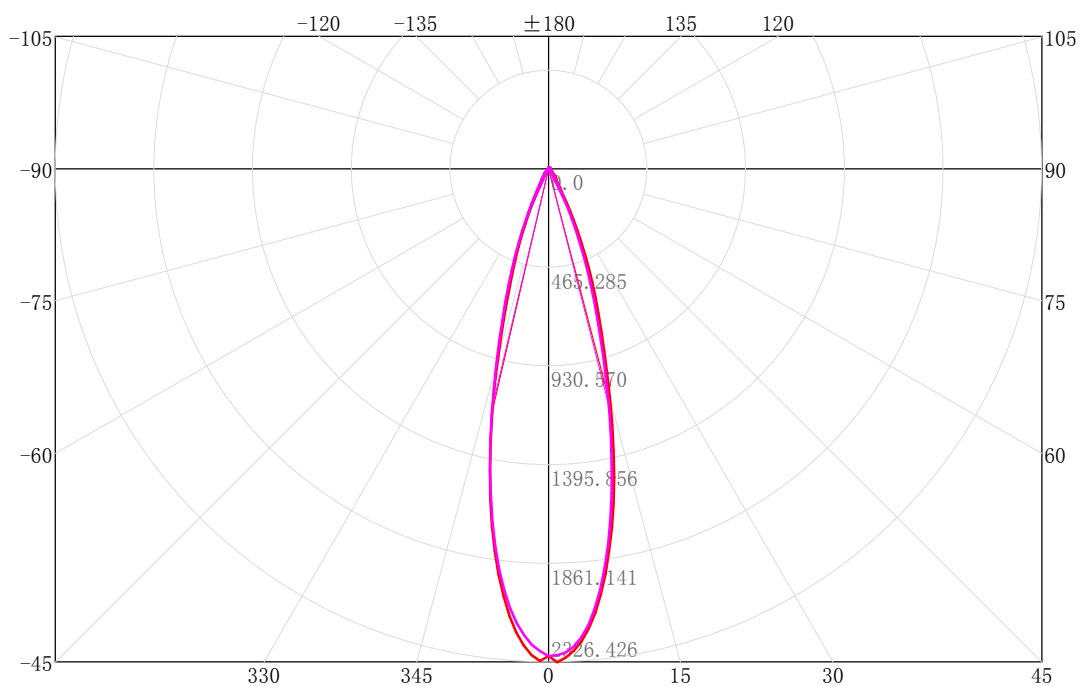

	C Plane	[50%MaxAng.]	[10%MaxAng.]	Unit:cd
—	C0.0_180.0 :	27.8	50.7	
—	C90.0_270.0 :	27.6	50.4	

IES Indoor Report

Photometric Filename:AD12541 10W 1202C9 3090 ZHT35-24D 250.IES

3D Light Intensity Distribution Modal

Lum. Name: AW12541	Lum. Catalog: Down Light	Test ID:
Lamp Name: 1202C9	Lamp Catalog: COB	Test Lab: Test
Manufacture:	Test Machine: GON-2000	Test Date: 2023/07/17

3D Light Intensity Distribution Modal

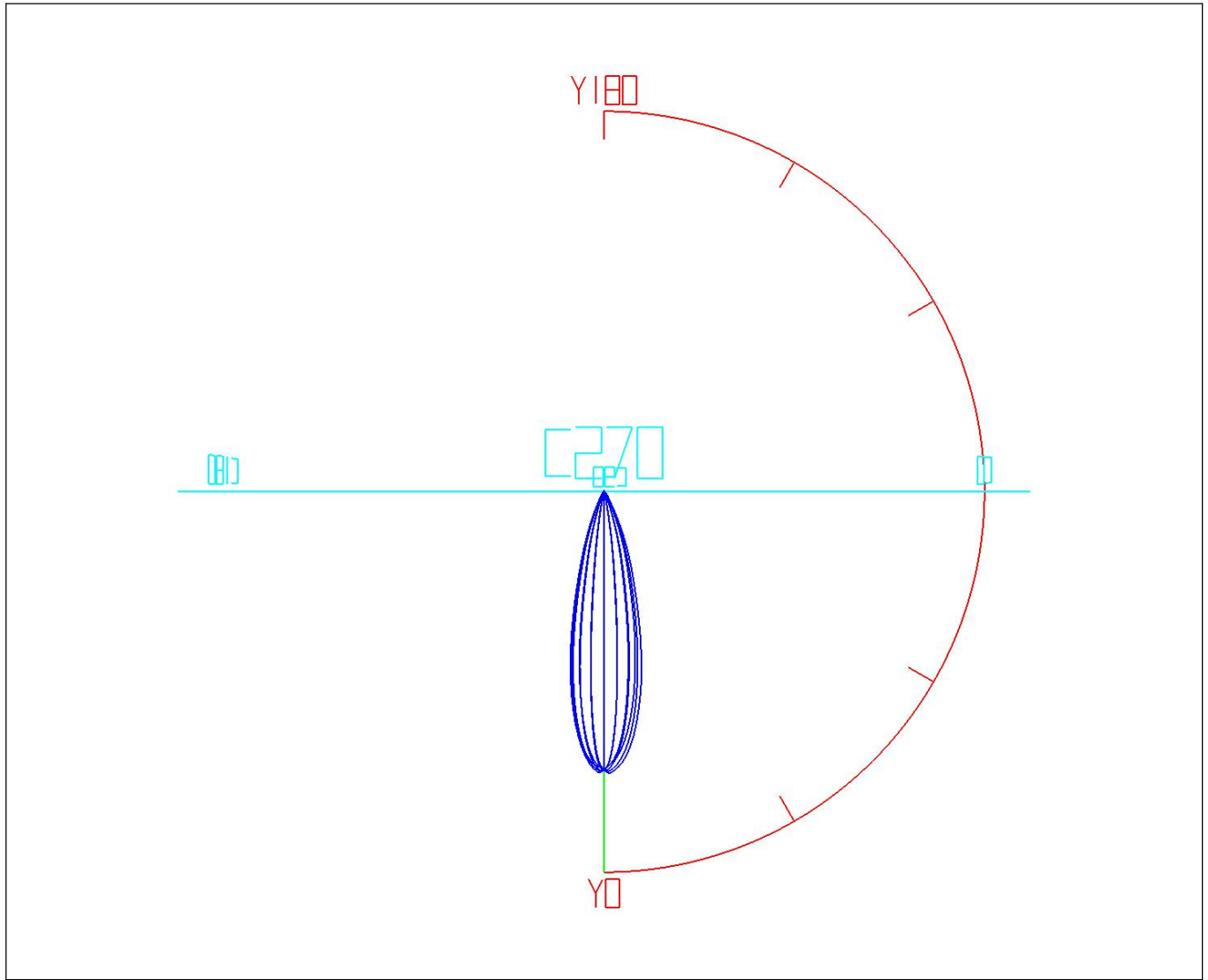

Curves: 3D Model ——— Fixture ——— Vert. HUD ——— Hori. HUD ———
View Angles: Orient:0 Tilt:0 Roll:0 Spin:0

IES Indoor Report

Photometric Filename:AD12541 10W 1202C9 3090 ZHT35-24D 250.IES

Zonal Flux Tabulation

Zone (γ)	Zone Flux (lm)	Sums Flux (lm)	Zone%Lamp	Sums%Lamp	Zone (γ)	Zone Flux (lm)	Sums Flux (lm)	Zone%Lamp	Sums%Lamp
0.0-1.0	2.20	2.20	0.33	0.33	47.0-48.0	1.25	628.74	0.19	95.26
1.0-2.0	6.55	8.74	0.99	1.32	48.0-49.0	1.05	629.80	0.16	95.42
2.0-3.0	10.77	19.51	1.63	2.96	49.0-50.0	0.88	630.68	0.13	95.56
3.0-4.0	14.79	34.30	2.24	5.20	50.0-51.0	0.76	631.44	0.12	95.67
4.0-5.0	18.52	52.82	2.81	8.00	51.0-52.0	0.67	632.11	0.10	95.77
5.0-6.0	21.88	74.71	3.32	11.32	52.0-53.0	0.61	632.72	0.09	95.87
6.0-7.0	24.80	99.51	3.76	15.08	53.0-54.0	0.57	633.29	0.09	95.95
7.0-8.0	27.23	126.74	4.13	19.20	54.0-55.0	0.54	633.82	0.08	96.03
8.0-9.0	29.12	155.86	4.41	23.62	55.0-56.0	0.51	634.33	0.08	96.11
9.0-10.0	30.47	186.33	4.62	28.23	56.0-57.0	0.49	634.82	0.07	96.18
10.0-11.0	31.26	217.59	4.74	32.97	57.0-58.0	0.46	635.28	0.07	96.25
11.0-12.0	31.50	249.10	4.77	37.74	58.0-59.0	0.44	635.72	0.07	96.32
12.0-13.0	31.22	280.32	4.73	42.47	59.0-60.0	0.42	636.14	0.06	96.39
13.0-14.0	30.45	310.77	4.61	47.09	60.0-61.0	0.41	636.55	0.06	96.45
14.0-15.0	29.25	340.02	4.43	51.52	61.0-62.0	0.40	636.95	0.06	96.51
15.0-16.0	27.77	367.78	4.21	55.72	62.0-63.0	0.38	637.33	0.06	96.57
16.0-17.0	26.14	393.92	3.96	59.69	63.0-64.0	0.37	637.71	0.06	96.62
17.0-18.0	24.49	418.41	3.71	63.40	64.0-65.0	0.36	638.07	0.06	96.68
18.0-19.0	22.85	441.26	3.46	66.86	65.0-66.0	0.35	638.42	0.05	96.73
19.0-20.0	21.23	462.49	3.22	70.07	66.0-67.0	0.35	638.77	0.05	96.78
20.0-21.0	19.57	482.06	2.96	73.04	67.0-68.0	0.34	639.11	0.05	96.83
21.0-22.0	17.80	499.86	2.70	75.74	68.0-69.0	0.33	639.44	0.05	96.89
22.0-23.0	15.93	515.78	2.41	78.15	69.0-70.0	0.33	639.77	0.05	96.93
23.0-24.0	14.03	529.82	2.13	80.28	70.0-71.0	0.32	640.09	0.05	96.98
24.0-25.0	12.20	542.01	1.85	82.12	71.0-72.0	0.31	640.40	0.05	97.03
25.0-26.0	10.47	552.49	1.59	83.71	72.0-73.0	0.31	640.71	0.05	97.08
26.0-27.0	8.92	561.41	1.35	85.06	73.0-74.0	0.30	641.01	0.05	97.12
27.0-28.0	7.58	568.99	1.15	86.21	74.0-75.0	0.30	641.31	0.05	97.17
28.0-29.0	6.46	575.45	0.98	87.19	75.0-76.0	0.30	641.61	0.05	97.21
29.0-30.0	5.54	580.99	0.84	88.03	76.0-77.0	0.30	641.91	0.04	97.26
30.0-31.0	4.80	585.78	0.73	88.75	77.0-78.0	0.30	642.21	0.04	97.30
31.0-32.0	4.22	590.00	0.64	89.39	78.0-79.0	0.30	642.50	0.05	97.35
32.0-33.0	3.78	593.78	0.57	89.97	79.0-80.0	0.29	642.80	0.04	97.39
33.0-34.0	3.48	597.26	0.53	90.49	80.0-81.0	0.29	643.08	0.04	97.44
34.0-35.0	3.26	600.52	0.49	90.99	81.0-82.0	0.28	643.37	0.04	97.48
35.0-36.0	3.07	603.60	0.47	91.45	82.0-83.0	0.28	643.65	0.04	97.52
36.0-37.0	2.90	606.50	0.44	91.89	83.0-84.0	0.28	643.94	0.04	97.57
37.0-38.0	2.74	609.25	0.42	92.31	84.0-85.0	0.28	644.22	0.04	97.61
38.0-39.0	2.60	611.84	0.39	92.70	85.0-86.0	0.28	644.50	0.04	97.65
39.0-40.0	2.46	614.30	0.37	93.08	86.0-87.0	0.28	644.78	0.04	97.69
40.0-41.0	2.32	616.62	0.35	93.43	87.0-88.0	0.27	645.05	0.04	97.73
41.0-42.0	2.18	618.79	0.33	93.76	88.0-89.0	0.27	645.32	0.04	97.78
42.0-43.0	2.04	620.83	0.31	94.07	89.0-90.0	0.27	645.58	0.04	97.82
43.0-44.0	1.89	622.72	0.29	94.35	90.0-91.0	0.27	645.85	0.04	97.86
44.0-45.0	1.74	624.46	0.26	94.62	91.0-92.0	0.26	646.11	0.04	97.90
45.0-46.0	1.59	626.06	0.24	94.86	92.0-93.0	0.26	646.37	0.04	97.94
46.0-47.0	1.44	627.49	0.22	95.07	93.0-94.0	0.26	646.63	0.04	97.97

IES Indoor Report

Photometric Filename:AD12541 10W 1202C9 3090 ZHT35-24D 250.IES

Zonal Flux Tabulation - (Cont.)

Zone (γ)	Zone Flux (lm)	Sums Flux (lm)	Zone%Lamp	Sums%Lamp	Zone (γ)	Zone Flux (lm)	Sums Flux (lm)	Zone%Lamp	Sums%Lamp
94.0-95.0	0.25	646.88	0.04	98.01	141.0-142.0	0.15	656.02	0.02	99.40
95.0-96.0	0.25	647.14	0.04	98.05	142.0-143.0	0.15	656.17	0.02	99.42
96.0-97.0	0.25	647.39	0.04	98.09	143.0-144.0	0.15	656.31	0.02	99.44
97.0-98.0	0.25	647.63	0.04	98.13	144.0-145.0	0.15	656.46	0.02	99.46
98.0-99.0	0.24	647.88	0.04	98.16	145.0-146.0	0.15	656.61	0.02	99.49
99.0-100.0	0.25	648.12	0.04	98.20	146.0-147.0	0.15	656.75	0.02	99.51
100.0-101.0	0.24	648.36	0.04	98.24	147.0-148.0	0.15	656.90	0.02	99.53
101.0-102.0	0.24	648.60	0.04	98.27	148.0-149.0	0.15	657.05	0.02	99.55
102.0-103.0	0.23	648.83	0.04	98.31	149.0-150.0	0.15	657.20	0.02	99.58
103.0-104.0	0.23	649.06	0.03	98.34	150.0-151.0	0.15	657.35	0.02	99.60
104.0-105.0	0.23	649.29	0.03	98.38	151.0-152.0	0.15	657.50	0.02	99.62
105.0-106.0	0.22	649.51	0.03	98.41	152.0-153.0	0.15	657.64	0.02	99.64
106.0-107.0	0.22	649.73	0.03	98.44	153.0-154.0	0.14	657.79	0.02	99.66
107.0-108.0	0.22	649.94	0.03	98.48	154.0-155.0	0.14	657.93	0.02	99.69
108.0-109.0	0.21	650.16	0.03	98.51	155.0-156.0	0.14	658.07	0.02	99.71
109.0-110.0	0.21	650.37	0.03	98.54	156.0-157.0	0.14	658.21	0.02	99.73
110.0-111.0	0.21	650.58	0.03	98.57	157.0-158.0	0.14	658.35	0.02	99.75
111.0-112.0	0.21	650.79	0.03	98.60	158.0-159.0	0.13	658.48	0.02	99.77
112.0-113.0	0.20	650.99	0.03	98.63	159.0-160.0	0.13	658.62	0.02	99.79
113.0-114.0	0.20	651.19	0.03	98.67	160.0-161.0	0.13	658.74	0.02	99.81
114.0-115.0	0.21	651.40	0.03	98.70	161.0-162.0	0.12	658.87	0.02	99.83
115.0-116.0	0.20	651.60	0.03	98.73	162.0-163.0	0.12	658.98	0.02	99.85
116.0-117.0	0.20	651.80	0.03	98.76	163.0-164.0	0.11	659.10	0.02	99.86
117.0-118.0	0.20	652.00	0.03	98.79	164.0-165.0	0.11	659.21	0.02	99.88
118.0-119.0	0.20	652.20	0.03	98.82	165.0-166.0	0.10	659.31	0.02	99.89
119.0-120.0	0.19	652.39	0.03	98.85	166.0-167.0	0.09	659.40	0.01	99.91
120.0-121.0	0.19	652.58	0.03	98.88	167.0-168.0	0.09	659.49	0.01	99.92
121.0-122.0	0.18	652.76	0.03	98.90	168.0-169.0	0.08	659.57	0.01	99.94
122.0-123.0	0.18	652.94	0.03	98.93	169.0-170.0	0.08	659.65	0.01	99.95
123.0-124.0	0.18	653.12	0.03	98.96	170.0-171.0	0.07	659.72	0.01	99.96
124.0-125.0	0.17	653.29	0.03	98.98	171.0-172.0	0.06	659.78	0.01	99.97
125.0-126.0	0.17	653.47	0.03	99.01	172.0-173.0	0.06	659.84	0.01	99.98
126.0-127.0	0.17	653.64	0.03	99.04	173.0-174.0	0.05	659.88	0.01	99.98
127.0-128.0	0.17	653.81	0.03	99.06	174.0-175.0	0.04	659.92	0.01	99.99
128.0-129.0	0.17	653.99	0.03	99.09	175.0-176.0	0.03	659.96	0.01	99.99
129.0-130.0	0.17	654.15	0.03	99.11	176.0-177.0	0.03	659.98	0.00	100.00
130.0-131.0	0.16	654.32	0.02	99.14	177.0-178.0	0.02	660.00	0.00	100.00
131.0-132.0	0.16	654.48	0.02	99.16	178.0-179.0	0.01	660.01	0.00	100.00
132.0-133.0	0.16	654.64	0.02	99.19	179.0-180.0	0.00	660.02	0.00	100.00
133.0-134.0	0.16	654.79	0.02	99.21					
134.0-135.0	0.16	654.95	0.02	99.24					
135.0-136.0	0.15	655.11	0.02	99.26					
136.0-137.0	0.15	655.26	0.02	99.28					
137.0-138.0	0.15	655.41	0.02	99.30					
138.0-139.0	0.15	655.56	0.02	99.33					
139.0-140.0	0.15	655.71	0.02	99.35					
140.0-141.0	0.15	655.87	0.02	99.37					

IES Indoor Report

Photometric Filename:AD12541 10W 1202C9 3090 ZHT35-24D 250.IES

Rectangle ISO Lighting Intensity Diagram

Lum. Name: AW12541	Lum. Catalog: Down Light	Test ID:
Lamp Name: 1202C9	Lamp Catalog: COB	Test Lab: Test
Manufacture:	Test Machine: GON-2000	Test Date: 2023/07/17

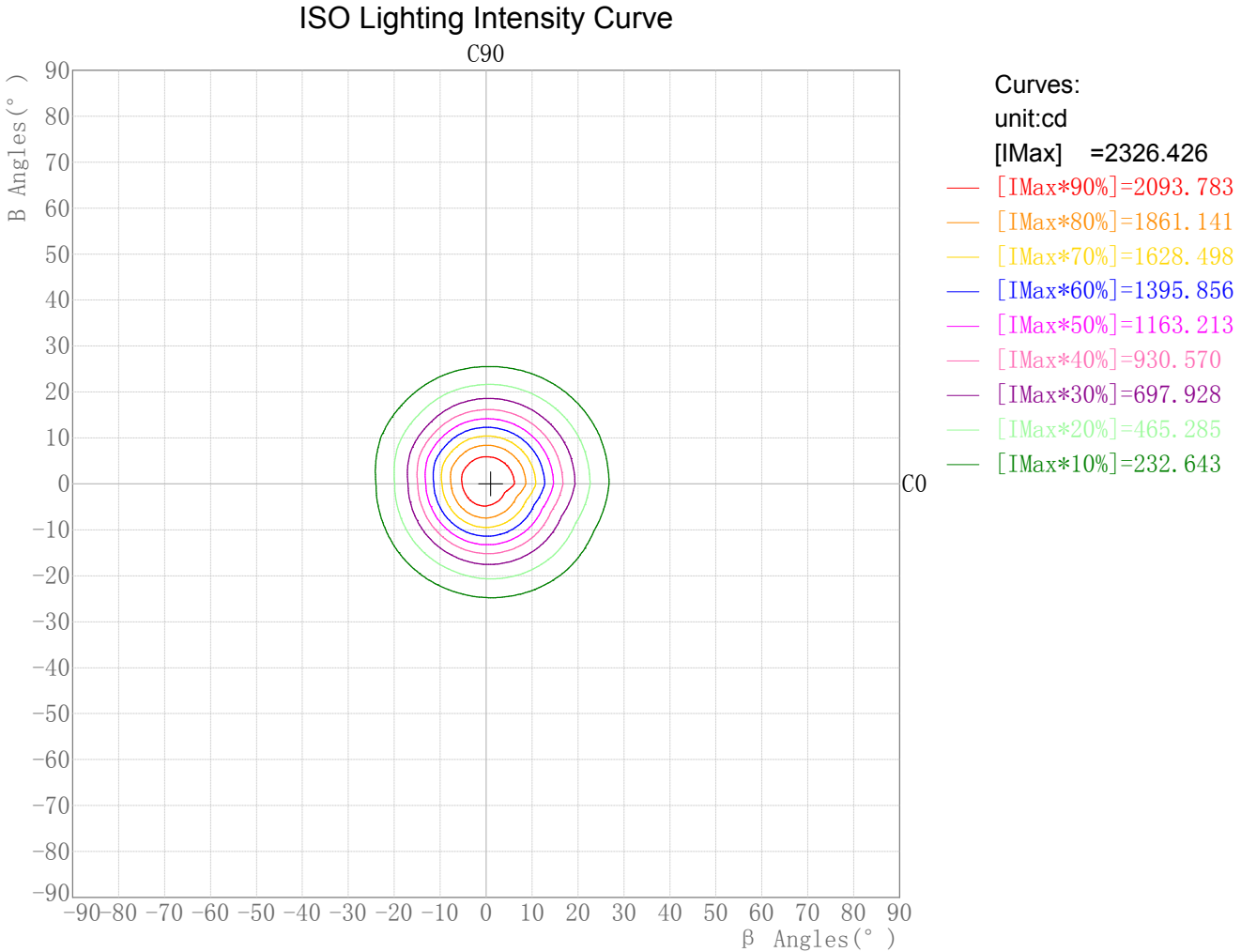

Maximum Light Intensity(cd): 2326.43
Maximum Cand.@Angle: H=1.0°,V=0.0°

IES Indoor Report

Photometric Filename:AD12541 10W 1202C9 3090 ZHT35-24D 250.IES

Round ISO Lighting Intensity Diagram

Lum. Name: AW12541	Lum. Catalog: Down Light	Test ID:
Lamp Name: 1202C9	Lamp Catalog: COB	Test Lab: Test
Manufacture:	Test Machine: GON-2000	Test Date: 2023/07/17

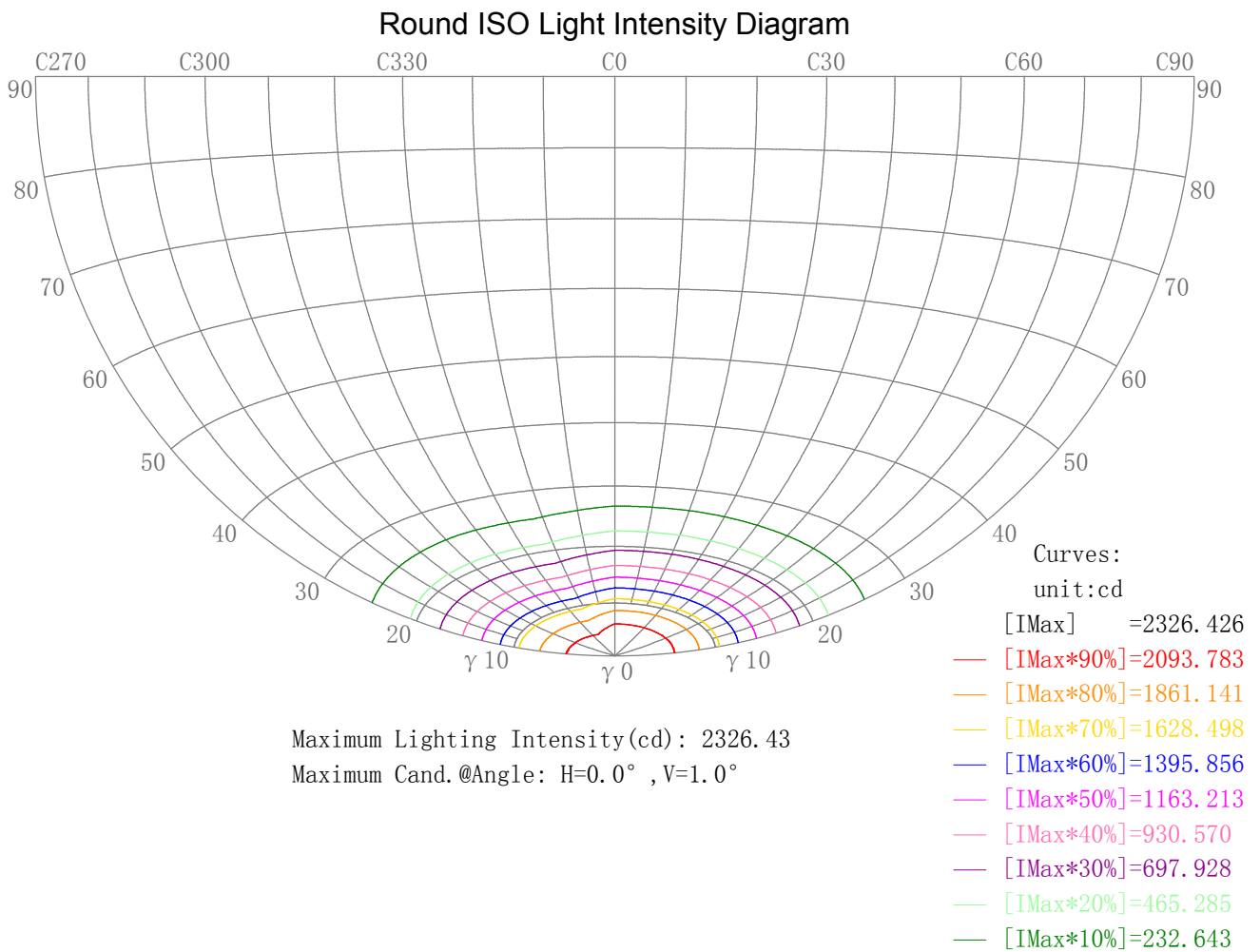

IES Indoor Report

Photometric Filename:AD12541 10W 1202C9 3090 ZHT35-24D 250.IES

Plane ISO-Illuminance Diagram

Lum. Name: AW12541	Lum. Catalog: Down Light	Test ID:
Lamp Name: 1202C9	Lamp Catalog: COB	Test Lab: Test
Manufacture:	Test Machine: GON-2000	Test Date: 2023/07/17

Plane ISO-Illuminance Curve

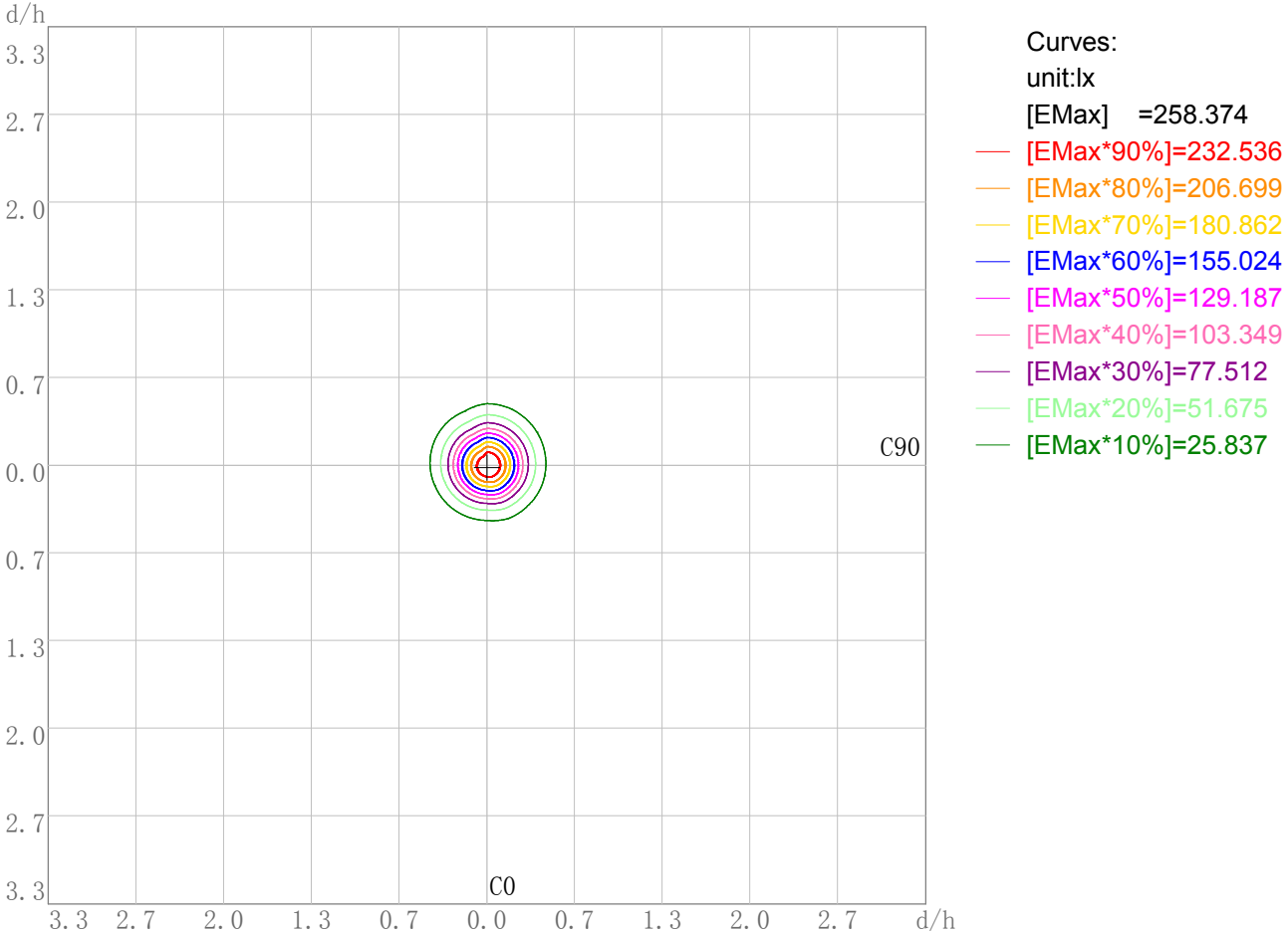

Working Plane Luminaire Mounting Height(m): 3.00
 Working Plane Maximum Illuminance(lx): 258.37
 Working Plane Maximum Illuminance Position(d/h):H0.0 V0.0

IES Indoor Report

Photometric Filename:AD12541 10W 1202C9 3090 ZHT35-24D 250.IES

3D Plane ISO Illuminance Diagram

Lum. Name: AW12541	Lum. Catalog: Down Light	Test ID:
Lamp Name: 1202C9	Lamp Catalog: COB	Test Lab: Test
Manufacture:	Test Machine: GON-2000	Test Date: 2023/07/17

3D Plane Illuminance Modal

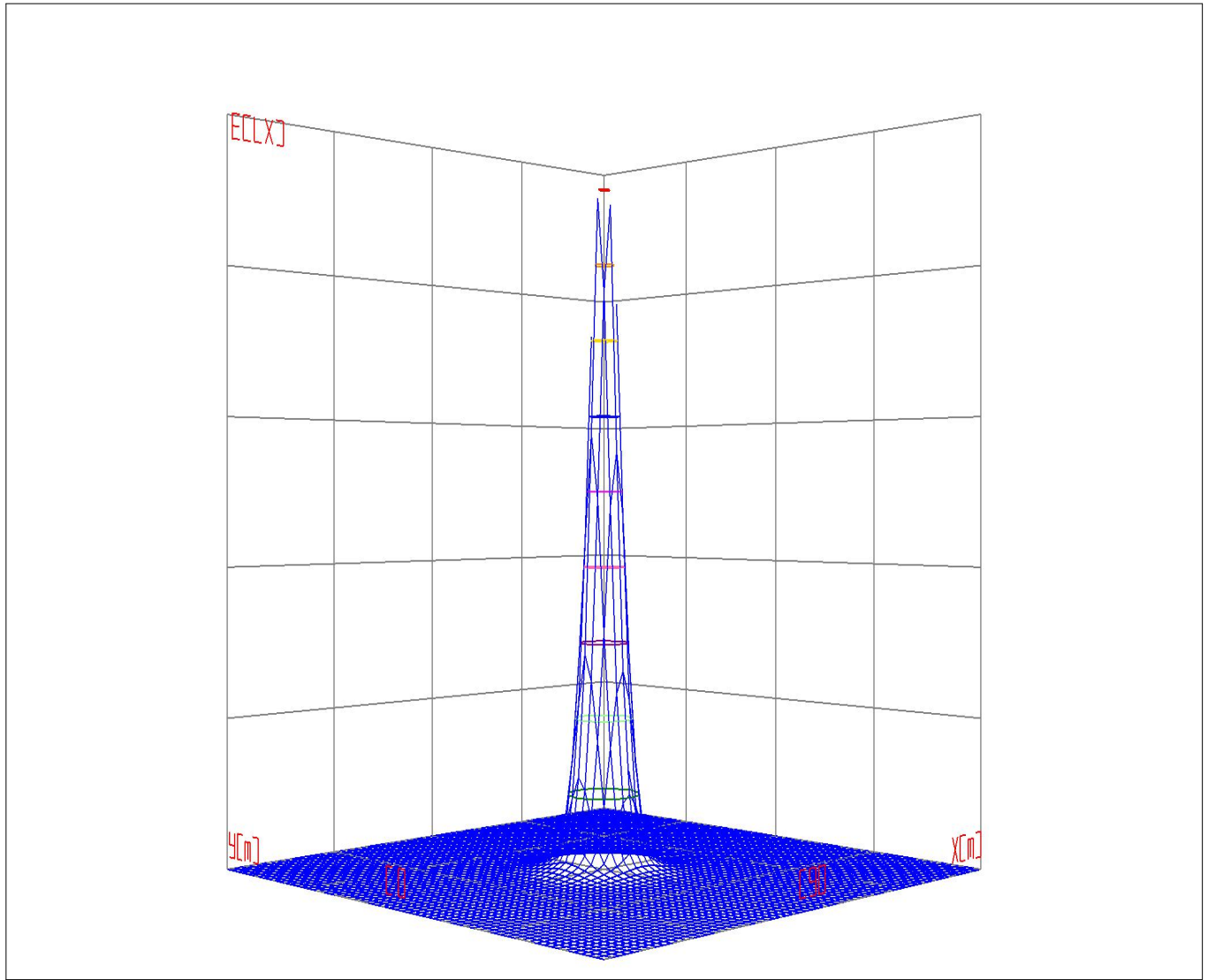

Curves: 3D Model — 90% — 80% — 70% — 60% — 50% — 40% — 30% — 20% — 10% —
View Angles(deg): 0 Height(m): 3.0 Distance(m): 10.0

IES Indoor Report

Photometric Filename:AD12541 10W 1202C9 3090 ZHT35-24D 250.IES

Space ISO Illuminance Diagram

Lum. Name: AW12541	Lum. Catalog: Down Light	Test ID:
Lamp Name: 1202C9	Lamp Catalog: COB	Test Lab: Test
Manufacture:	Test Machine: GON-2000	Test Date: 2023/07/17

Space ISO Illuminance Curve

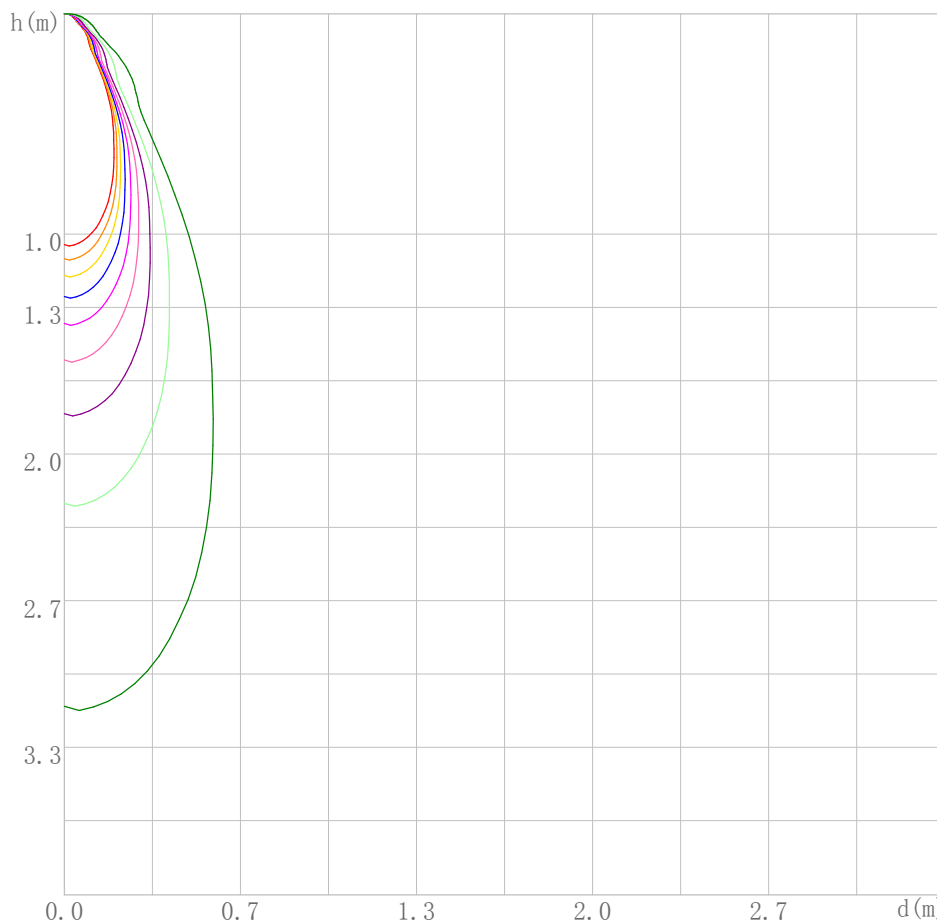

- Curves:
[Unit: lx]
[EMax] =2325.363
- [EMax*90%]=2092.827
 - [EMax*80%]=1860.291
 - [EMax*70%]=1627.754
 - [EMax*60%]=1395.218
 - [EMax*50%]=1162.682
 - [EMax*40%]=930.145
 - [EMax*30%]=697.609
 - [EMax*20%]=465.073
 - [EMax*10%]=232.536

Space Plane Maximum Illuminance and @Angle:2325.36lx,1.0deg
Plane Maximum Lighting Intensity and @Angle:2326.426cd,0deg

IES Indoor Report

Photometric Filename:AD12541 10W 1202C9 3090 ZHT35-24D 250.IES

Illuminance-Distance Diagram

Lum. Name: AW12541	Lum. Catalog: Down Light	Test ID:
Lamp Name: 1202C9	Lamp Catalog: COB	Test Lab: Test
Manufacture:	Test Machine:GON-2000	Test Date: 2023/07/17

Illuminance-Distance Curve

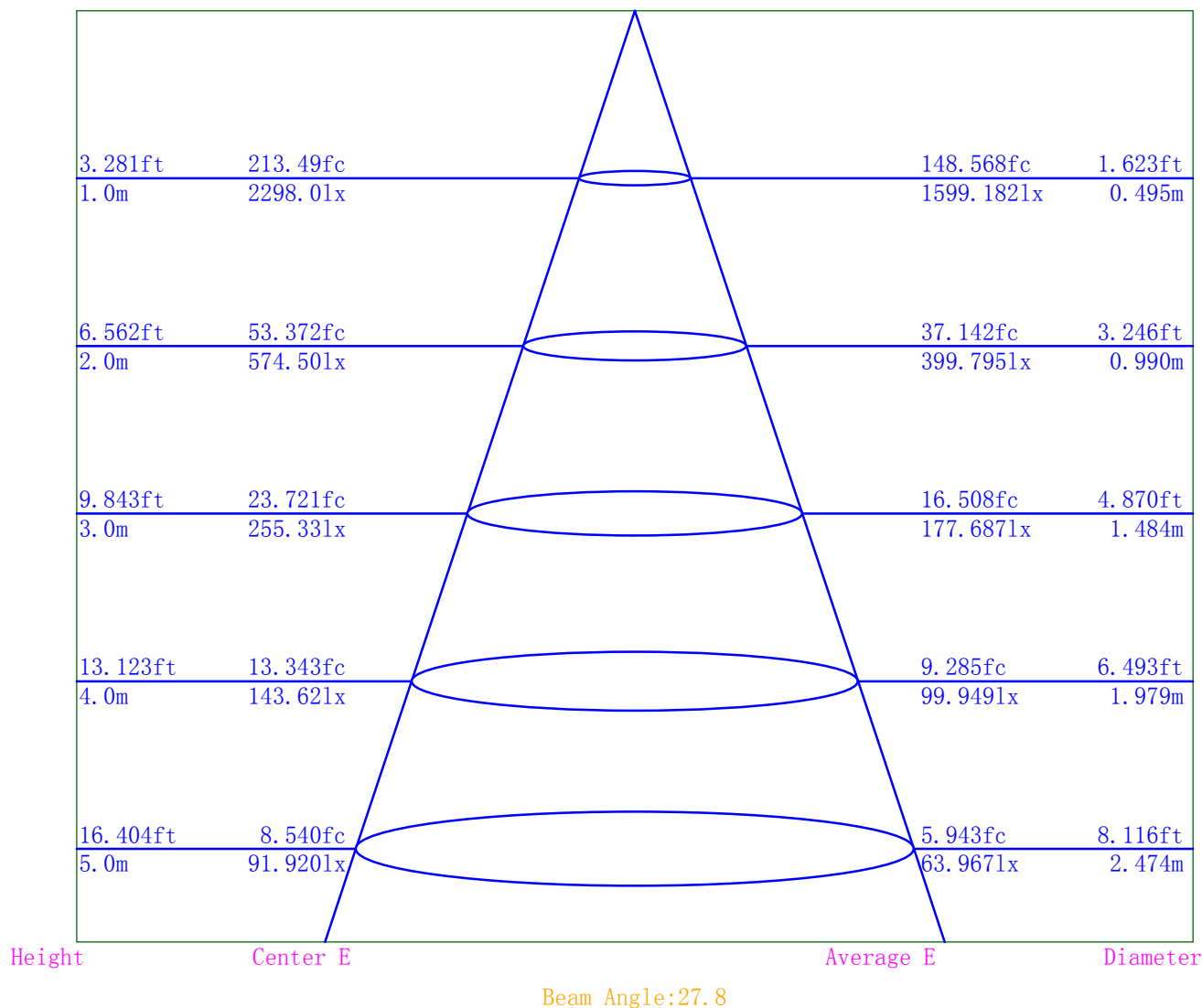

IES Indoor Report

Photometric Filename:AD12541 10W 1202C9 3090 ZHT35-24D 250.IES

Indoor Luminance Limiting Curves

Lum. Name: AW12541	Lum. Catalog: Down Light	Test ID:
Lamp Name: 1202C9	Lamp Catalog: COB	Test Lab: Test
Manufacture:	Test Machine:GON-2000	Test Date: 2023/07/17

Glare Grade Table

GI	Quality	Using Illuminance							
1.15	A	2000	1000	500	<=300				
1.5	B		2000	1000	500	<=300			
1.85	C			2000	1000	500	<=300		
2.2	D				2000	1000	500	<=300	
2.55	E	a				2000	1000	500	<=300
			b	c	d	e	f	g	h

Luminance Table

Gama(deg)	45	50	55	60	65	70	75	80	85
C0	13649	7556	5147	4832	4731	5208	5936	8071	13998
C90	8564	5222	4572	4170	4337	4461	5388	7117	12432

Luminance Limiting Curve

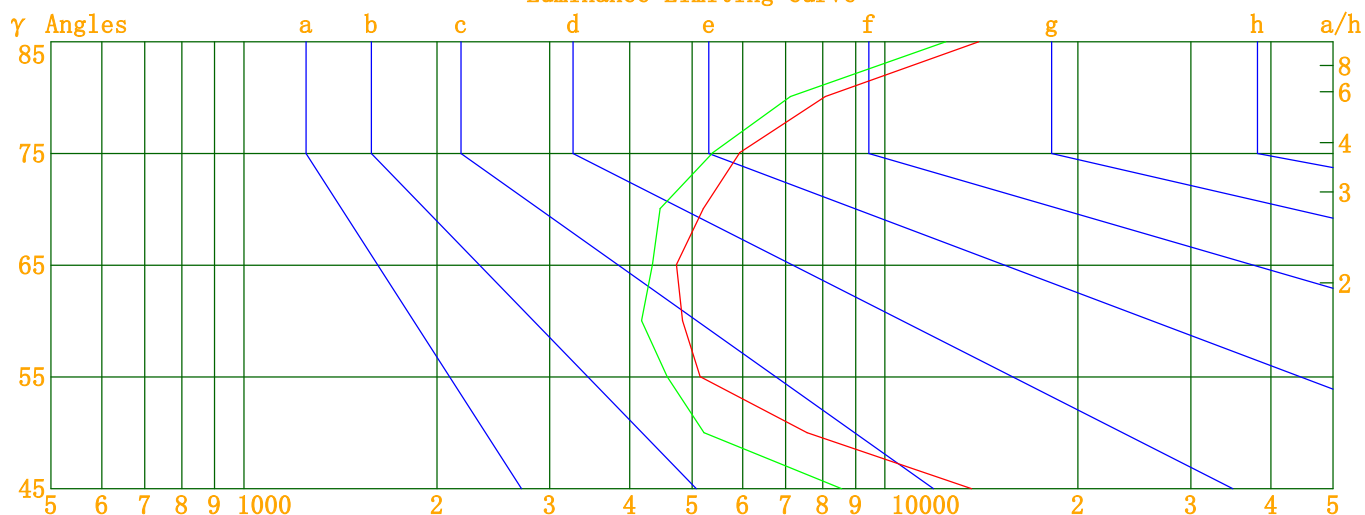

Luminous Size: Length(m)=-0.066 Width(m)=-0.066 Height(m)=0.000 Area(m^2)=0.003421
 Luminous Type: Without Luminous Side
 Luminous Curves: C0-C180 Color: — C90-C270 Color: —

IES Indoor Report

Photometric Filename: AD12541 10W 1202C9 3090 ZHT35-24D 250.IES

Indoor Budgetary Estimate Table

Lum. Name: AW12541	Lum. Catalog: Down Light	Test ID:
Lamp Name: 1202C9	Lamp Catalog: COB	Test Lab: Test
Manufacture:	Test Machine: GON-2000	Test Date: 2023/07/17

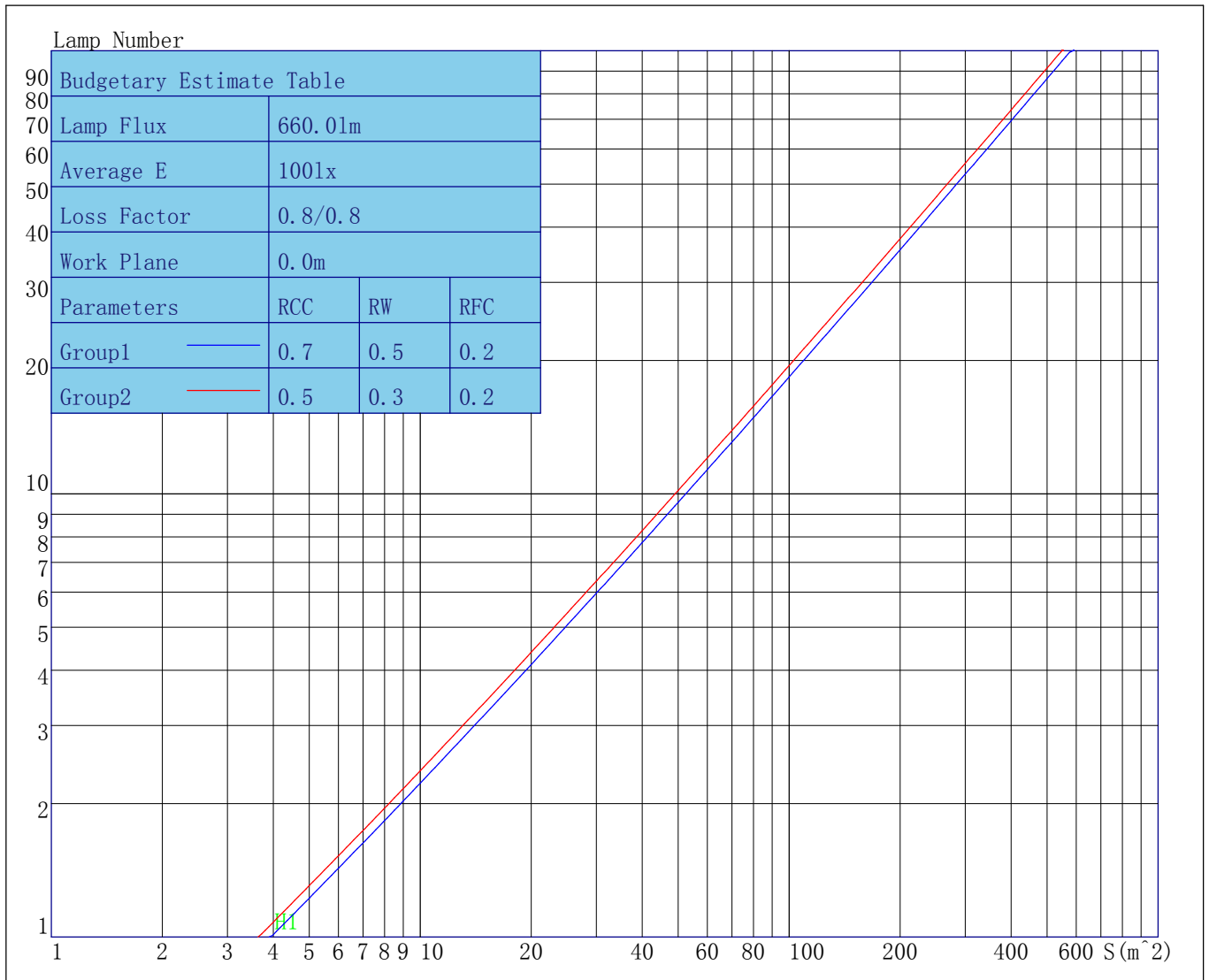

Parameters1: Rhocc = 0.7 Rhow = 0.5 Rhofc = 0.2 LLF = 0.8
 Parameters2: Rhocc = 0.5 Rhow = 0.3 Rhofc = 0.2 LLF = 0.8
 Average Illuminance(lx): 100 Cavity Height: H1(m) = 2

IES Indoor Report

Photometric Filename:AD12541 10W 1202C9 3090 ZHT35-24D 250.IES

Indoor Coefficient of Utilization Table

Lum. Name: AW12541	Lum. Catalog: Down Light	Test ID:
Lamp Name: 1202C9	Lamp Catalog: COB	Test Lab: Test
Manufacture:	Test Machine:GON-2000	Test Date: 2023/07/17

Coefficients of Utilization - Zonal Cavity Method																		
Coef.	Effective Floor Cavity Reflectance RFC=0.20																	
RhoCC (%)	80				70				50			30			10			0
RhoW (%)	70	50	30	10	70	50	30	10	50	30	10	50	30	10	50	30	10	0
RCR	Coefficient of Utilization (%)																	
0	119	119	119	119	116	116	116	116	110	110	110	105	105	105	100	100	100	98
1	114	111	109	107	111	109	107	105	105	103	102	101	99	98	97	96	95	93
2	109	105	102	99	107	103	100	98	100	97	95	97	95	93	94	92	91	89
3	105	100	96	93	103	99	95	92	96	93	90	93	91	88	91	89	87	85
4	102	95	91	88	100	94	90	87	92	88	86	90	87	85	88	85	83	82
5	98	91	87	83	96	90	86	83	88	85	82	87	83	81	85	82	80	79
6	95	88	83	80	93	87	82	79	85	81	79	84	80	78	82	79	77	76
7	92	84	80	76	90	84	79	76	82	78	75	81	78	75	80	77	74	73
8	89	81	77	73	87	81	76	73	79	76	73	78	75	72	77	74	72	71
9	86	78	74	71	85	78	74	71	77	73	70	76	72	70	75	72	70	69
10	83	76	71	68	82	75	71	68	75	71	68	74	70	68	73	70	67	66

IES Indoor Report

Photometric Filename:AD12541 10W 1202C9 3090 ZHT35-24D 250.IES

Unified Glare Rating Table

Lum. Name: AW12541	Lum. Catalog: Down Light	Test ID:
Lamp Name: 1202C9	Lamp Catalog: COB	Test Lab: Test
Manufacture:	Test Machine:GON-2000	Test Date: 2023/07/17

Unified Glare Rating Table

Ceiling RCC	0.70	0.70	0.50	0.50	0.30	0.70	0.70	0.50	0.50	0.30
Wall RW	0.50	0.30	0.50	0.30	0.30	0.50	0.30	0.50	0.30	0.30
Floor RFC	0.20	0.20	0.20	0.20	0.20	0.20	0.20	0.20	0.20	0.20
Room Size	Vewed crosswise					Vewed endwise				
X=2H Y=2H	12.7	13.6	13.1	14.0	14.4	11.9	12.8	12.3	13.1	13.5
Y=3H	13.3	14.1	13.7	14.5	14.9	12.8	13.6	13.2	14.0	14.4
Y=4H	13.8	14.6	14.2	15.0	15.4	13.4	14.2	13.9	14.6	15.1
Y=6H	14.6	15.3	15.0	15.7	16.1	14.3	15.0	14.8	15.4	15.9
Y=8H	15.1	15.7	15.6	16.2	16.7	14.8	15.5	15.3	15.9	16.4
Y=12H	15.8	16.4	16.3	16.9	17.4	15.5	16.1	16.0	16.5	17.0
X=4H Y=2H	12.6	13.4	13.1	13.8	14.2	12.1	12.8	12.5	13.2	13.7
Y=3H	13.4	14.0	13.9	14.5	14.9	13.3	13.9	13.8	14.4	14.9
Y=4H	14.1	14.6	14.5	15.1	15.6	14.2	14.7	14.7	15.2	15.7
Y=6H	15.1	15.6	15.6	16.0	16.6	15.3	15.8	15.8	16.3	16.8
Y=8H	15.7	16.2	16.3	16.7	17.2	16.0	16.4	16.5	16.9	17.4
Y=12H	16.7	17.1	17.2	17.6	18.1	16.8	17.2	17.3	17.7	18.3
X=8H Y=4H	14.2	14.7	14.7	15.1	15.7	14.6	15.0	15.1	15.5	16.0
Y=6H	15.4	15.8	16.0	16.3	16.9	16.0	16.3	16.5	16.9	17.5
Y=8H	16.3	16.6	16.8	17.1	17.7	16.8	17.2	17.4	17.7	18.3
Y=12H	17.4	17.7	18.0	18.2	18.8	17.9	18.2	18.5	18.8	19.4
X=12H Y=4H	14.2	14.6	14.8	15.1	15.7	14.7	15.0	15.2	15.6	16.1
Y=6H	15.5	15.9	16.1	16.4	17.0	16.2	16.5	16.8	17.0	17.6
Y=8H	16.5	16.7	17.0	17.3	17.9	17.2	17.5	17.7	18.0	18.6
Variations with the objverer position at spacings										
S=1.0H	0.1/-0.1					0.1/-0.1				
S=1.5H	0.2/-0.2					0.1/-0.2				
S=2.0H	0.3/-0.5					0.1/-0.1				
Reduced UGR Table:										
Nordic Standard Table:	BKO					BKO				
Correction Value	3.1					3.9				

o the CIE Pub. 117, data has been corrected, refers to the lamp's lumens 8.2flm.

IES Indoor Report

Photometric Filename:AD12541 10W 1202C9 3090 ZHT35-24D 250.IES

Candela Tabulation

V/H	C0.0	C22.5	C45.0	C67.5	C90.0	C112.5	C135.0	C157.5	C180.0	C202.5	C225.0	C247.5
γ 0.0	2297.99	2297.99	2297.99	2297.99	2297.99	2297.99	2297.99	2297.99	2297.99	2297.99	2297.99	2297.99
γ 1.0	2326.43	2314.42	2306.69	2299.97	2293.98	2289.57	2283.49	2278.64	2321.34	2302.51	2293.36	2283.61
γ 2.0	2306.29	2297.00	2291.02	2287.13	2282.84	2280.56	2273.13	2268.51	2294.70	2273.36	2265.17	2255.08
γ 3.0	2275.04	2267.66	2261.34	2259.80	2257.25	2255.73	2247.27	2242.86	2250.23	2228.70	2221.40	2211.44
γ 4.0	2233.27	2226.92	2220.16	2217.25	2216.04	2216.05	2204.54	2199.56	2191.37	2169.32	2163.60	2155.69
γ 5.0	2175.43	2171.72	2165.25	2161.19	2158.06	2159.32	2146.88	2142.14	2117.40	2095.14	2091.25	2088.36
γ 6.0	2105.78	2102.69	2095.31	2091.01	2085.60	2084.65	2072.22	2068.89	2028.10	2008.13	2006.68	2005.03
γ 7.0	2022.62	2021.12	2012.83	2006.85	2000.04	1999.52	1984.84	1981.14	1930.82	1909.25	1908.03	1908.33
γ 8.0	1928.46	1927.27	1918.77	1910.85	1901.49	1900.98	1886.59	1883.09	1821.24	1798.96	1798.91	1799.86
γ 9.0	1823.37	1823.10	1813.74	1803.89	1793.72	1792.43	1778.28	1775.21	1704.36	1680.74	1681.61	1684.37
γ 10.0	1718.94	1710.84	1700.22	1689.06	1678.48	1676.10	1661.03	1659.19	1579.90	1556.05	1557.33	1562.61
γ 11.0	1607.94	1593.70	1579.83	1567.85	1557.50	1552.74	1537.38	1536.06	1449.72	1427.17	1429.27	1436.45
γ 12.0	1487.15	1473.73	1456.62	1444.72	1432.80	1428.36	1410.59	1408.75	1316.50	1295.12	1297.33	1307.79
γ 13.0	1365.28	1351.88	1333.30	1320.81	1307.13	1303.05	1281.09	1279.30	1181.23	1161.29	1164.82	1178.67
γ 14.0	1242.81	1230.32	1210.77	1197.05	1182.69	1175.64	1151.37	1147.93	1046.27	1029.56	1035.13	1051.14
γ 15.0	1121.44	1110.29	1091.25	1077.33	1061.94	1049.23	1023.25	1018.13	916.60	904.55	911.16	929.82
γ 16.0	1004.98	995.93	978.49	964.33	947.60	931.20	900.65	894.34	798.46	791.36	799.04	818.84
γ 17.0	900.58	891.66	875.02	859.18	843.79	821.72	788.96	780.69	696.28	692.17	700.58	718.00
γ 18.0	806.02	799.02	780.79	763.30	749.11	725.85	691.45	681.10	607.26	605.54	613.64	628.81
γ 19.0	723.09	716.74	695.81	676.86	663.48	640.54	605.60	595.67	528.97	528.81	536.43	549.23
γ 20.0	647.89	641.68	618.50	599.01	584.69	563.43	528.99	520.82	458.64	459.51	467.28	478.80
γ 21.0	576.12	570.38	546.36	525.42	510.55	492.06	459.31	453.61	394.84	394.89	402.96	414.15
γ 22.0	507.08	500.53	475.50	454.62	439.17	421.37	394.34	389.99	334.47	333.86	341.96	353.15
γ 23.0	440.14	433.67	408.80	387.81	372.27	356.32	333.47	330.66	279.79	277.96	285.06	296.49
γ 24.0	377.66	371.10	346.84	326.30	311.48	297.48	278.21	276.31	231.43	228.91	234.78	246.49
γ 25.0	320.02	313.63	290.68	271.18	257.15	245.68	229.71	228.58	189.93	187.32	191.78	202.06
γ 26.0	267.19	262.05	240.43	223.17	210.07	201.10	188.72	188.05	155.79	153.07	155.90	164.84
γ 27.0	221.45	216.75	196.90	182.15	170.55	164.60	155.19	155.35	128.69	125.73	127.22	135.04
γ 28.0	182.66	178.00	160.81	147.35	138.21	135.70	128.66	129.36	107.59	104.40	105.39	111.45
γ 29.0	150.41	145.59	131.03	119.67	112.61	111.94	107.60	108.43	90.88	87.72	88.41	93.07
γ 30.0	124.61	119.59	107.10	97.04	92.32	93.39	90.95	92.03	77.64	74.61	75.01	78.78
γ 31.0	104.50	99.59	88.80	79.79	76.69	79.12	77.88	79.16	67.21	64.36	64.50	67.43
γ 32.0	89.04	84.52	75.03	67.18	64.98	68.19	67.67	68.66	58.63	56.40	56.50	58.97
γ 33.0	78.06	74.06	65.80	58.58	57.02	60.32	60.02	61.04	52.48	50.11	50.10	52.45
γ 34.0	71.14	67.28	59.62	52.81	51.07	54.21	53.94	55.35	47.64	44.99	45.24	47.40
γ 35.0	67.04	62.61	55.10	47.90	46.25	48.95	48.55	50.35	42.92	40.59	41.03	43.53
γ 36.0	63.27	58.87	50.90	43.77	42.46	44.01	44.28	45.80	39.35	36.96	37.24	39.67
γ 37.0	59.41	55.07	46.80	40.06	38.97	40.08	40.51	41.90	36.03	33.90	33.94	36.16
γ 38.0	56.01	51.38	43.08	36.87	35.78	36.90	37.18	38.46	32.76	31.13	31.27	32.76
γ 39.0	53.11	48.07	39.78	34.25	33.11	33.96	34.34	35.50	29.88	28.61	28.74	29.92
γ 40.0	49.95	44.64	36.74	31.38	30.67	31.21	31.83	33.13	27.41	26.03	26.58	27.58
γ 41.0	46.60	41.08	33.58	29.27	28.65	29.13	29.37	30.76	25.15	23.92	24.79	25.28
γ 42.0	43.22	37.60	30.68	27.23	26.66	26.75	27.28	28.48	22.78	22.04	22.90	23.21
γ 43.0	39.58	34.28	28.50	25.38	24.60	24.69	25.01	26.20	20.54	20.15	20.92	21.59
γ 44.0	36.47	31.20	26.36	23.72	22.78	22.39	22.61	23.84	17.76	18.10	19.24	19.74
γ 45.0	33.02	28.35	24.29	21.94	20.72	20.70	20.59	21.52	15.56	15.71	17.25	17.92
γ 46.0	29.76	25.74	22.01	19.74	18.76	19.08	19.01	19.66	13.53	13.59	14.87	16.22

IES Indoor Report

Photometric Filename:AD12541 10W 1202C9 3090 ZHT35-24D 250.IES

Candela Tabulation - (Cont.)

V/H	C0.0	C22.5	C45.0	C67.5	C90.0	C112.5	C135.0	C157.5	C180.0	C202.5	C225.0	C247.5
γ 47.0	26.71	23.23	19.69	17.69	17.29	17.05	16.43	17.23	10.53	11.31	12.73	13.82
γ 48.0	23.63	20.09	17.41	16.06	15.39	14.95	14.07	14.23	7.48	8.48	10.18	11.40
γ 49.0	18.59	17.16	15.72	14.37	13.29	12.48	12.08	12.22	5.37	6.04	7.50	9.01
γ 50.0	16.62	15.22	13.77	12.60	11.48	11.08	10.84	11.03	4.08	4.68	5.21	6.75
γ 51.0	14.96	13.58	12.00	11.09	10.58	10.27	10.19	10.10	3.73	3.84	3.86	4.94
γ 52.0	12.96	11.90	10.84	10.44	10.06	9.99	9.87	9.64	3.50	3.24	3.38	3.92
γ 53.0	11.57	10.75	10.37	10.15	9.57	9.53	9.59	9.51	2.98	2.79	3.14	3.46
γ 54.0	10.53	10.18	9.68	9.57	9.20	9.31	9.21	8.95	2.78	2.50	2.60	2.99
γ 55.0	10.10	9.79	9.28	9.17	8.97	8.73	8.81	8.62	2.35	2.16	2.24	2.52
γ 56.0	9.79	9.38	8.76	8.86	8.69	8.45	8.50	8.23	2.19	1.85	2.04	2.36
γ 57.0	9.10	8.81	8.56	8.71	8.14	8.08	8.21	7.84	2.06	1.79	1.68	2.14
γ 58.0	8.78	8.55	8.23	8.20	7.76	7.71	7.66	7.55	1.70	1.48	1.41	1.88
γ 59.0	8.65	8.21	8.12	7.84	7.51	7.60	7.42	7.29	1.61	1.28	1.14	1.71
γ 60.0	8.27	7.90	7.83	7.73	7.13	7.17	7.24	7.00	1.27	1.33	1.09	1.50
γ 61.0	8.02	7.68	7.35	7.34	7.17	7.10	6.90	6.68	1.32	1.17	1.12	1.32
γ 62.0	7.69	7.28	7.01	7.15	6.93	6.96	6.80	6.66	1.22	1.02	0.86	1.10
γ 63.0	7.42	7.06	6.89	6.85	6.65	6.64	6.41	6.33	1.14	0.92	1.16	0.97
γ 64.0	7.23	6.83	6.72	6.80	6.50	6.12	6.17	6.18	1.09	0.82	1.11	0.92
γ 65.0	6.84	6.54	6.67	6.58	6.27	6.15	6.14	6.08	1.18	0.60	0.88	0.98
γ 66.0	6.60	6.53	6.31	6.71	6.04	5.72	5.82	5.91	0.95	0.41	0.90	0.86
γ 67.0	6.67	6.47	6.34	6.30	6.00	5.61	5.76	5.80	0.93	0.58	0.85	0.94
γ 68.0	6.31	6.23	5.94	5.88	5.72	5.46	5.47	5.51	0.90	0.69	0.86	0.65
γ 69.0	6.06	5.88	6.03	5.96	5.46	5.58	5.27	5.35	1.23	0.81	1.00	1.01
γ 70.0	6.09	5.61	5.70	5.61	5.22	5.06	5.16	5.35	1.08	0.92	0.77	0.76
γ 71.0	6.11	5.48	5.55	5.45	5.10	5.07	5.12	4.99	0.89	0.84	0.78	0.87
γ 72.0	5.84	5.44	5.30	5.37	4.95	4.80	4.95	4.95	0.95	0.82	1.05	0.78
γ 73.0	5.45	5.31	5.01	5.04	4.74	4.76	4.96	4.85	0.96	0.99	1.00	0.60
γ 74.0	5.36	5.22	5.00	4.93	4.86	4.65	4.80	4.50	0.91	1.00	0.94	0.78
γ 75.0	5.26	5.15	4.83	4.98	4.77	4.52	4.78	4.43	0.95	0.91	1.01	0.82
γ 76.0	5.03	4.87	4.62	5.00	4.57	4.27	4.61	4.37	1.12	1.08	0.93	0.82
γ 77.0	5.13	4.67	4.73	4.76	4.52	4.26	4.40	4.26	1.36	1.16	1.03	0.78
γ 78.0	4.81	4.52	5.00	4.73	4.33	4.26	4.52	4.10	1.12	1.16	1.14	0.98
γ 79.0	4.54	4.63	4.83	4.56	4.29	4.06	4.40	4.16	1.35	1.21	1.25	1.22
γ 80.0	4.80	4.59	4.46	4.26	4.23	3.67	4.13	4.16	1.16	1.14	1.25	1.20
γ 81.0	4.38	4.35	4.21	4.36	4.01	3.78	4.09	3.89	1.27	1.36	1.17	1.18
γ 82.0	4.27	4.26	4.37	4.34	3.73	3.52	3.98	3.79	1.36	1.53	1.46	1.19
γ 83.0	4.48	4.18	4.25	4.40	3.70	3.61	3.86	3.80	1.42	1.56	1.43	1.31
γ 84.0	4.22	4.11	4.18	4.33	3.69	3.47	3.75	3.67	1.50	1.52	1.69	1.25
γ 85.0	4.17	3.96	4.09	3.91	3.71	3.59	3.69	3.50	1.54	1.53	1.52	1.52
γ 86.0	3.74	3.79	4.06	3.68	3.81	3.46	3.55	3.58	1.61	1.65	1.67	1.45
γ 87.0	3.96	3.72	4.03	3.71	3.67	3.21	3.30	3.51	1.52	1.60	1.65	1.41
γ 88.0	3.78	3.70	3.87	3.63	3.38	3.24	3.09	3.46	1.56	1.72	1.59	1.29
γ 89.0	3.61	3.58	3.57	3.60	3.33	3.23	3.13	3.24	1.50	1.93	1.43	1.33
γ 90.0	3.56	3.38	3.79	3.48	3.25	3.10	3.43	3.16	1.68	1.90	1.29	1.19
γ 91.0	3.51	3.27	3.88	3.49	3.13	3.07	3.43	3.25	1.58	1.81	1.57	1.33
γ 92.0	3.24	3.28	3.67	3.69	3.21	2.91	3.18	3.21	1.43	1.79	1.57	1.38
γ 93.0	3.03	3.39	3.59	3.40	3.14	2.81	3.15	3.24	1.63	1.75	1.47	1.48

IES Indoor Report

Photometric Filename:AD12541 10W 1202C9 3090 ZHT35-24D 250.IES

Candela Tabulation - (Cont.)

V/H	C0.0	C22.5	C45.0	C67.5	C90.0	C112.5	C135.0	C157.5	C180.0	C202.5	C225.0	C247.5
γ 94.0	3.23	3.38	3.28	3.41	2.95	2.88	2.83	3.13	1.67	1.79	1.64	1.52
γ 95.0	3.27	3.28	3.50	3.15	3.01	2.86	2.87	2.88	1.70	1.95	1.54	1.43
γ 96.0	3.10	3.27	3.43	3.20	3.09	2.55	2.79	2.82	1.45	1.93	1.55	1.35
γ 97.0	2.80	3.27	3.29	3.19	2.98	2.60	2.73	2.94	1.70	1.71	1.83	1.55
γ 98.0	2.74	3.08	3.08	3.18	2.87	2.64	2.75	2.80	1.56	1.55	1.72	1.53
γ 99.0	3.16	3.08	3.10	3.24	2.83	2.49	2.65	2.70	1.75	1.77	1.70	1.63
γ 100.0	2.97	3.17	3.11	3.18	2.80	2.56	2.36	2.61	1.95	1.91	1.82	1.60
γ 101.0	2.84	2.96	2.97	3.15	2.75	2.58	2.35	2.40	1.86	1.76	1.76	1.53
γ 102.0	2.75	3.00	2.90	2.73	2.62	2.61	2.29	2.36	1.88	1.62	1.76	1.63
γ 103.0	2.83	3.00	2.83	2.72	2.57	2.20	2.46	2.57	1.86	1.64	1.97	1.68
γ 104.0	2.53	2.76	2.78	2.62	2.61	2.34	2.45	2.55	1.85	1.74	1.67	1.48
γ 105.0	2.69	2.69	2.81	2.49	2.51	2.27	2.33	2.48	1.79	1.75	1.56	1.72
γ 106.0	2.26	2.79	2.75	2.78	2.49	2.33	2.20	2.63	1.61	1.88	1.75	1.65
γ 107.0	2.42	2.81	2.97	2.60	2.46	1.97	2.35	2.68	1.65	2.01	1.93	1.38
γ 108.0	2.44	2.76	2.68	2.54	2.43	2.09	2.28	2.70	1.93	1.90	1.92	1.36
γ 109.0	2.44	2.88	2.67	2.35	2.21	2.00	2.11	2.55	2.06	1.85	1.70	1.45
γ 110.0	2.60	2.78	2.65	2.24	2.11	2.19	2.36	2.53	1.89	1.92	1.79	1.54
γ 111.0	2.64	2.62	2.45	2.39	2.19	2.08	2.40	2.42	1.75	1.95	1.79	1.63
γ 112.0	2.47	2.57	2.54	2.29	2.10	2.40	2.22	2.37	2.06	1.87	1.74	1.64
γ 113.0	2.46	2.57	2.46	2.39	2.23	2.08	2.33	2.19	1.95	1.89	1.88	1.65
γ 114.0	2.62	2.66	2.39	2.26	2.36	2.27	2.27	2.44	1.72	2.01	1.94	1.58
γ 115.0	2.59	2.65	2.37	2.30	2.18	2.11	2.30	2.41	2.13	1.92	1.92	1.54
γ 116.0	2.30	2.55	2.24	2.35	2.14	2.00	2.09	2.36	2.00	2.03	1.81	1.65
γ 117.0	2.70	2.70	2.26	2.28	2.13	2.02	2.22	2.26	2.06	2.06	1.84	1.71
γ 118.0	2.48	2.85	2.36	2.15	2.03	2.01	2.16	2.23	2.13	2.04	1.68	1.82
γ 119.0	2.58	2.57	2.44	2.24	2.01	1.87	1.95	2.37	2.11	2.11	1.66	1.61
γ 120.0	2.40	2.32	2.39	2.34	2.16	2.11	1.99	2.17	1.98	2.15	1.66	1.64
γ 121.0	2.12	2.48	2.36	2.16	2.19	1.69	1.94	2.25	1.93	2.16	1.77	1.73
γ 122.0	1.92	2.50	2.25	2.16	2.24	1.75	1.94	2.22	1.96	2.02	1.77	1.77
γ 123.0	2.27	2.42	1.91	1.99	2.13	1.76	2.06	2.13	1.86	1.99	2.03	1.83
γ 124.0	2.07	2.50	2.25	2.10	2.04	1.68	2.12	2.07	1.87	2.04	1.99	1.40
γ 125.0	2.03	2.42	2.14	2.14	2.04	1.77	2.02	2.10	1.92	1.98	1.84	1.33
γ 126.0	2.12	2.22	1.99	2.13	2.17	1.96	1.98	1.93	2.13	1.95	1.98	1.47
γ 127.0	2.00	2.24	2.05	2.17	2.22	1.65	2.07	1.93	2.23	2.11	1.89	1.80
γ 128.0	2.35	2.39	2.20	1.96	2.13	1.95	2.00	2.09	2.38	2.16	1.90	1.64
γ 129.0	2.29	2.33	2.28	1.98	2.29	1.80	1.77	2.07	2.31	2.09	1.94	1.69
γ 130.0	2.12	2.42	2.26	2.10	2.37	1.80	1.71	2.06	2.16	2.16	1.93	1.46
γ 131.0	2.07	2.26	2.33	2.10	2.23	1.73	1.77	2.01	1.93	2.17	2.09	1.60
γ 132.0	2.16	2.18	2.21	2.07	1.85	1.92	1.69	1.94	2.24	2.16	2.14	1.68
γ 133.0	2.04	2.47	2.25	2.04	1.82	1.91	1.78	1.96	2.46	2.17	2.05	1.47
γ 134.0	2.19	2.44	1.98	1.92	1.88	1.82	1.71	2.13	2.25	2.19	1.98	1.79
γ 135.0	2.27	2.24	2.08	2.18	1.86	1.68	1.97	2.25	2.25	2.26	2.11	1.95
γ 136.0	2.26	2.16	2.08	1.85	1.78	1.79	2.08	2.14	2.19	2.22	2.12	1.81
γ 137.0	2.57	2.12	2.23	2.00	1.79	1.74	1.83	2.20	2.34	2.28	2.29	2.03
γ 138.0	2.44	2.15	1.87	2.04	1.95	1.87	1.95	2.17	2.47	2.30	2.33	1.84
γ 139.0	2.33	2.42	2.06	2.17	1.94	1.78	2.04	2.20	2.53	2.46	2.10	1.88
γ 140.0	2.69	2.67	2.11	2.14	2.06	1.78	2.13	2.23	2.21	2.62	2.23	2.10

IES Indoor Report

Photometric Filename:AD12541 10W 1202C9 3090 ZHT35-24D 250.IES

Candela Tabulation - (Cont.)

V/H	C0.0	C22.5	C45.0	C67.5	C90.0	C112.5	C135.0	C157.5	C180.0	C202.5	C225.0	C247.5
γ 141.0	2.71	2.60	2.18	2.27	2.20	1.99	2.10	2.09	2.24	2.62	2.24	2.14
γ 142.0	2.61	2.47	2.33	2.07	2.16	1.91	2.14	2.11	2.61	2.60	2.39	2.27
γ 143.0	2.44	2.55	2.48	2.33	2.20	1.76	2.20	2.03	2.49	2.36	2.49	2.20
γ 144.0	2.60	2.69	2.59	2.11	2.33	2.04	2.26	2.35	2.73	2.37	2.57	2.17
γ 145.0	2.68	2.78	2.36	2.11	2.31	2.12	2.23	2.44	2.87	2.46	2.53	2.22
γ 146.0	2.62	2.69	2.38	2.39	2.30	2.13	2.44	2.57	2.80	2.71	2.61	2.17
γ 147.0	2.61	2.57	2.40	2.53	2.46	2.09	2.30	2.53	2.88	2.94	2.81	2.39
γ 148.0	2.70	2.71	2.32	2.66	2.49	2.04	2.36	2.51	2.97	2.87	2.87	2.63
γ 149.0	3.10	3.01	2.47	2.58	2.61	2.22	2.43	2.59	2.83	2.92	3.01	2.61
γ 150.0	3.03	3.16	2.66	2.47	2.65	2.29	2.62	2.78	3.05	2.96	2.76	2.70
γ 151.0	3.09	3.25	2.59	2.79	2.92	2.69	2.62	3.02	3.13	3.05	3.12	2.53
γ 152.0	2.92	3.42	2.78	2.86	3.19	2.59	2.79	3.00	3.18	2.94	3.09	2.75
γ 153.0	3.11	3.31	3.04	2.76	3.13	2.57	2.89	3.02	3.18	2.92	2.98	3.05
γ 154.0	3.05	3.11	3.11	3.14	3.19	2.62	2.92	2.87	3.33	3.03	3.26	3.20
γ 155.0	3.27	3.07	3.23	3.22	3.33	3.05	2.90	2.86	3.33	3.11	3.32	3.19
γ 156.0	3.44	3.19	3.36	3.44	3.28	3.14	3.09	3.05	3.42	3.25	3.53	3.05
γ 157.0	3.50	3.39	3.69	3.28	3.27	2.90	3.15	3.29	3.37	3.37	3.22	3.23
γ 158.0	3.80	3.37	3.69	3.53	3.15	2.87	3.23	3.42	3.53	3.41	3.45	3.18
γ 159.0	3.65	3.53	3.81	3.68	3.28	3.05	3.42	3.48	3.57	3.38	3.62	3.39
γ 160.0	3.78	3.69	3.84	3.71	3.65	3.05	3.33	3.49	3.68	3.50	3.64	3.49
γ 161.0	3.78	3.65	3.96	3.71	3.70	3.10	3.28	3.52	3.55	3.52	3.51	3.28
γ 162.0	3.90	3.79	3.84	3.84	3.80	3.07	3.53	3.50	3.61	3.58	3.67	3.45
γ 163.0	4.10	3.89	3.78	4.02	3.89	2.96	3.72	3.61	3.87	3.72	3.67	3.48
γ 164.0	3.89	3.89	3.77	4.12	3.88	3.19	3.79	3.72	4.00	3.86	3.74	3.71
γ 165.0	4.11	3.96	3.74	3.81	3.83	3.25	3.77	3.69	3.77	3.85	3.78	3.73
γ 166.0	3.93	3.97	3.78	3.87	3.66	3.06	3.57	3.61	4.02	3.83	3.90	3.81
γ 167.0	4.06	3.94	4.07	4.08	3.68	3.31	3.47	3.55	3.89	3.87	4.02	3.46
γ 168.0	4.24	4.06	4.11	4.14	3.80	3.46	3.51	3.76	3.94	3.86	4.05	3.57
γ 169.0	4.26	4.11	4.10	3.84	3.89	3.36	3.56	3.85	3.75	4.02	4.06	3.62
γ 170.0	4.27	3.97	3.98	3.84	3.91	3.61	3.57	3.97	3.94	4.11	4.19	3.64
γ 171.0	4.20	4.02	4.18	3.89	3.95	3.39	3.61	4.11	4.06	4.17	4.17	3.77
γ 172.0	4.28	4.13	4.02	3.99	3.98	3.59	3.57	4.08	3.83	4.18	4.38	3.83
γ 173.0	4.41	4.09	4.17	3.89	3.96	3.49	3.42	3.91	3.79	4.08	4.16	3.84
γ 174.0	4.34	4.28	4.19	3.95	3.80	3.31	3.60	3.80	4.16	4.06	4.41	3.90
γ 175.0	4.24	4.36	4.26	4.21	3.84	3.42	3.48	3.77	3.89	3.95	4.32	3.78
γ 176.0	4.32	4.36	4.06	4.20	3.90	3.50	3.41	3.95	4.00	4.05	4.18	3.77
γ 177.0	4.24	4.29	4.09	4.09	3.88	3.36	3.71	3.82	4.01	4.19	4.19	3.97
γ 178.0	4.04	4.20	4.01	3.93	3.88	3.45	3.59	3.79	3.93	4.16	4.34	3.85
γ 179.0	4.14	4.25	4.09	4.00	3.91	3.30	3.62	3.67	4.05	4.25	4.37	3.86
γ 180.0	3.89	3.89	3.89	3.89	3.89	3.89	3.89	3.89	3.89	3.89	3.89	3.89
V/H	C270.0	C292.5	C315.0	C337.5								
γ 0.0	2297.99	2297.99	2297.99	2297.99								
γ 1.0	2275.40	2267.07	2261.04	2254.42								
γ 2.0	2245.52	2235.46	2230.46	2223.91								
γ 3.0	2203.17	2193.44	2187.99	2180.56								
γ 4.0	2149.35	2137.50	2131.56	2123.35								
γ 5.0	2081.13	2066.71	2060.96	2053.32								

IES Indoor Report

Photometric Filename:AD12541 10W 1202C9 3090 ZHT35-24D 250.IES

Candela Tabulation - (Cont.)

V/H	C270. 0	C292. 5	C315. 0	C337. 5
γ 6. 0	1999. 70	1984. 07	1978. 30	1971. 83
γ 7. 0	1906. 09	1890. 72	1885. 39	1879. 74
γ 8. 0	1801. 64	1787. 45	1783. 31	1779. 51
γ 9. 0	1688. 75	1678. 28	1675. 30	1672. 05
γ 10. 0	1568. 90	1563. 71	1561. 36	1558. 90
γ 11. 0	1445. 14	1445. 39	1444. 80	1442. 80
γ 12. 0	1319. 54	1325. 48	1326. 38	1325. 08
γ 13. 0	1193. 27	1203. 45	1206. 37	1206. 07
γ 14. 0	1069. 21	1080. 48	1086. 77	1085. 84
γ 15. 0	951. 22	963. 04	971. 10	968. 56
γ 16. 0	842. 12	855. 67	864. 09	861. 86
γ 17. 0	744. 63	760. 00	769. 43	767. 03
γ 18. 0	657. 51	675. 05	685. 88	683. 44
γ 19. 0	579. 09	599. 73	611. 65	610. 08
γ 20. 0	508. 23	531. 22	543. 99	543. 07
γ 21. 0	442. 09	465. 68	480. 36	478. 87
γ 22. 0	379. 17	401. 81	418. 39	416. 90
γ 23. 0	320. 41	341. 57	359. 43	358. 07
γ 24. 0	267. 43	287. 07	303. 92	303. 49
γ 25. 0	220. 94	238. 21	253. 57	253. 77
γ 26. 0	181. 42	195. 06	208. 59	209. 46
γ 27. 0	148. 51	159. 41	170. 08	171. 14
γ 28. 0	122. 55	131. 19	139. 03	139. 87
γ 29. 0	102. 43	108. 62	114. 78	115. 28
γ 30. 0	86. 69	91. 24	95. 89	96. 07
γ 31. 0	74. 22	78. 29	81. 60	81. 28
γ 32. 0	64. 66	67. 86	70. 74	70. 88
γ 33. 0	57. 52	60. 56	62. 95	63. 97
γ 34. 0	52. 39	55. 64	57. 75	59. 41
γ 35. 0	48. 04	51. 53	53. 68	55. 69
γ 36. 0	44. 03	48. 16	50. 24	52. 31
γ 37. 0	40. 50	44. 00	47. 04	49. 12
γ 38. 0	37. 37	41. 06	43. 85	45. 74
γ 39. 0	34. 60	38. 16	40. 95	42. 65
γ 40. 0	31. 66	35. 03	38. 00	39. 68
γ 41. 0	28. 83	32. 24	34. 80	36. 35
γ 42. 0	26. 40	28. 96	31. 91	33. 02
γ 43. 0	24. 15	26. 01	28. 89	29. 69
γ 44. 0	21. 81	23. 27	25. 81	26. 16
γ 45. 0	19. 63	20. 48	23. 13	23. 03
γ 46. 0	17. 27	18. 23	20. 44	20. 28
γ 47. 0	14. 33	15. 72	17. 82	17. 75
γ 48. 0	11. 64	12. 67	14. 55	13. 91
γ 49. 0	9. 50	9. 86	10. 48	10. 18
γ 50. 0	7. 36	7. 82	8. 46	7. 94
γ 51. 0	5. 42	5. 60	6. 76	6. 14
γ 52. 0	3. 94	4. 01	4. 93	4. 59

IES Indoor Report

Photometric Filename:AD12541 10W 1202C9 3090 ZHT35-24D 250.IES

Candela Tabulation - (Cont.)

V/H	C270.0	C292.5	C315.0	C337.5
γ 53.0	3.40	3.14	3.62	3.27
γ 54.0	3.17	2.64	3.18	2.59
γ 55.0	2.69	2.40	2.72	2.42
γ 56.0	2.23	2.12	2.25	2.02
γ 57.0	1.93	1.59	2.05	1.64
γ 58.0	1.56	1.11	1.70	1.41
γ 59.0	1.39	1.32	1.43	1.16
γ 60.0	1.24	0.95	1.33	1.01
γ 61.0	1.26	0.58	1.07	0.90
γ 62.0	1.11	0.97	1.01	0.81
γ 63.0	1.22	0.71	1.01	0.59
γ 64.0	1.06	0.80	0.90	0.49
γ 65.0	0.94	0.49	0.91	0.64
γ 66.0	0.85	0.47	0.87	0.42
γ 67.0	0.89	0.43	0.81	0.36
γ 68.0	0.83	0.58	0.90	0.25
γ 69.0	0.77	0.77	0.92	0.38
γ 70.0	0.68	0.28	0.68	0.36
γ 71.0	0.81	0.61	0.78	0.36
γ 72.0	0.93	0.55	0.75	0.54
γ 73.0	0.95	0.67	0.70	0.61
γ 74.0	0.89	0.77	0.75	0.50
γ 75.0	0.84	0.70	0.65	0.64
γ 76.0	1.05	0.86	0.72	0.73
γ 77.0	1.04	0.60	0.90	0.85
γ 78.0	1.11	0.95	0.78	0.73
γ 79.0	1.26	0.87	0.83	0.83
γ 80.0	1.24	0.87	0.81	0.85
γ 81.0	1.27	0.98	0.89	0.96
γ 82.0	1.31	0.73	0.97	0.90
γ 83.0	1.34	0.71	1.08	0.88
γ 84.0	1.44	0.85	1.08	0.93
γ 85.0	1.48	0.99	1.14	0.86
γ 86.0	1.40	1.22	1.29	0.90
γ 87.0	1.45	0.99	1.25	0.86
γ 88.0	1.69	0.93	1.38	0.95
γ 89.0	1.76	1.45	1.53	1.08
γ 90.0	1.69	1.07	1.29	1.21
γ 91.0	1.49	1.61	1.33	1.24
γ 92.0	1.59	1.46	1.44	1.25
γ 93.0	1.80	1.22	1.46	1.08
γ 94.0	1.73	1.12	1.32	1.16
γ 95.0	1.73	1.37	1.53	1.41
γ 96.0	1.75	1.46	1.45	1.50
γ 97.0	1.82	1.19	1.59	1.39
γ 98.0	1.88	1.43	1.61	1.45
γ 99.0	1.75	1.53	1.51	1.43

IES Indoor Report

Photometric Filename:AD12541 10W 1202C9 3090 ZHT35-24D 250.IES

Candela Tabulation - (Cont.)

V/H	C270.0	C292.5	C315.0	C337.5
γ 100.0	1.64	1.61	1.38	1.52
γ 101.0	1.76	1.73	1.47	1.44
γ 102.0	1.90	1.61	1.57	1.47
γ 103.0	1.91	1.55	1.70	1.52
γ 104.0	1.89	1.55	1.73	1.53
γ 105.0	1.72	1.65	1.74	1.74
γ 106.0	1.51	1.48	1.46	1.60
γ 107.0	1.55	1.33	1.66	1.63
γ 108.0	1.74	1.42	1.48	1.59
γ 109.0	1.74	1.56	1.49	1.59
γ 110.0	1.51	1.40	1.67	1.60
γ 111.0	1.53	1.52	1.55	1.55
γ 112.0	1.60	1.26	1.52	1.41
γ 113.0	1.69	1.38	1.56	1.52
γ 114.0	1.84	1.38	1.47	1.70
γ 115.0	1.76	1.70	1.54	1.80
γ 116.0	1.67	1.65	1.50	1.76
γ 117.0	1.67	1.60	1.65	1.80
γ 118.0	1.76	1.67	1.56	1.89
γ 119.0	1.75	1.74	1.63	1.95
γ 120.0	1.84	1.63	1.54	2.04
γ 121.0	1.87	1.59	1.48	1.90
γ 122.0	1.85	1.59	1.47	1.84
γ 123.0	1.86	1.41	1.39	1.91
γ 124.0	1.77	1.62	1.33	1.83
γ 125.0	1.73	1.84	1.45	1.90
γ 126.0	1.86	1.73	1.67	1.97
γ 127.0	1.86	1.78	1.53	1.96
γ 128.0	1.79	1.75	1.65	1.87
γ 129.0	1.78	1.84	1.80	1.92
γ 130.0	1.78	1.63	1.72	1.95
γ 131.0	1.69	1.75	1.50	1.77
γ 132.0	1.61	1.92	1.65	1.68
γ 133.0	1.77	1.97	1.73	1.92
γ 134.0	1.87	1.79	1.86	1.98
γ 135.0	1.72	1.76	1.86	2.10
γ 136.0	1.79	1.94	1.57	2.02
γ 137.0	1.96	1.93	1.69	2.07
γ 138.0	1.81	1.73	1.79	2.10
γ 139.0	1.76	2.05	1.84	1.99
γ 140.0	1.88	2.06	1.76	2.05
γ 141.0	1.96	1.85	2.01	1.95
γ 142.0	2.12	2.03	1.96	2.01
γ 143.0	2.07	1.99	1.85	1.99
γ 144.0	1.88	1.99	1.92	2.02
γ 145.0	1.82	2.30	2.09	2.05
γ 146.0	2.10	2.18	2.07	2.30

IES Indoor Report

Photometric Filename:AD12541 10W 1202C9 3090 ZHT35-24D 250.IES

Candela Tabulation - (Cont.)

V/H	C270. 0	C292. 5	C315. 0	C337. 5
γ 147. 0	2. 31	2. 26	1. 96	2. 42
γ 148. 0	2. 50	2. 05	1. 92	2. 67
γ 149. 0	2. 55	2. 48	1. 98	2. 73
γ 150. 0	2. 50	2. 61	2. 16	2. 84
γ 151. 0	2. 62	2. 41	2. 19	2. 98
γ 152. 0	2. 66	2. 64	2. 41	2. 86
γ 153. 0	2. 64	2. 63	2. 64	2. 87
γ 154. 0	2. 77	2. 73	2. 71	2. 94
γ 155. 0	3. 00	2. 61	2. 61	3. 19
γ 156. 0	2. 99	2. 74	2. 53	3. 34
γ 157. 0	2. 87	3. 00	2. 65	3. 44
γ 158. 0	2. 99	3. 15	2. 91	3. 28
γ 159. 0	3. 12	2. 98	2. 81	3. 51
γ 160. 0	3. 24	3. 11	2. 99	3. 60
γ 161. 0	3. 38	3. 15	3. 03	3. 38
γ 162. 0	3. 31	3. 29	3. 08	3. 33
γ 163. 0	3. 32	3. 32	3. 13	3. 50
γ 164. 0	3. 34	3. 20	3. 13	3. 64
γ 165. 0	3. 25	3. 44	3. 34	3. 62
γ 166. 0	3. 33	3. 47	3. 39	3. 47
γ 167. 0	3. 56	3. 40	3. 39	3. 50
γ 168. 0	3. 37	3. 21	3. 48	3. 58
γ 169. 0	3. 37	3. 77	3. 52	3. 65
γ 170. 0	3. 57	3. 53	3. 47	3. 63
γ 171. 0	3. 61	3. 75	3. 54	3. 72
γ 172. 0	3. 59	3. 66	3. 51	3. 85
γ 173. 0	3. 56	3. 21	3. 32	3. 69
γ 174. 0	3. 48	3. 67	3. 48	3. 36
γ 175. 0	3. 41	3. 44	3. 58	3. 44
γ 176. 0	3. 52	3. 07	3. 58	3. 67
γ 177. 0	3. 57	3. 35	3. 61	3. 70
γ 178. 0	3. 65	3. 53	3. 53	3. 73
γ 179. 0	3. 69	3. 33	3. 62	3. 58
γ 180. 0	3. 89	3. 89	3. 89	3. 89
