

IES Indoor Report

Photometric Filename:AW12540 15W 1204C9 3090 ZHT35-24D 350.IES

Indoor Luminaire Photometric Data

Description Information

Luminary Name: AW12540	Lum. Catalog: Down Light	Test ID:
Lamp Name: 1204C9	Lamp Catalog: COB	Test Date: 2023/06/30
Manufacture: -	Shld. Ang(°):24	Test Machine:GON-2000
Test Lab: Test	Frequency(Hz):50	Lamp CCT(K): 3000 Ra: 90
Lum. Size(W*L*H):0.066m*0.066m*0.000m	Lum. Area(m ²):0.003	Lum. W(kg): 0.000
Test System: C, γ	Test Step: C=22.5 γ=1.0	Temp.(°C): 25
		Humidity(%): 50.0

Character Parameter

Lamp Speciality Parameter		Luminaire Speciality Parameter	
Rated Flux(lm): 784.000	Luminary Flux(lm): 784.074	Field Angle(10%Imax): 51.5(°)	
Rated Power(W): 15	Luminary Efficiency: 100.01%	Down Lumens&Percent: 760.513lm 97.00%	
Rated Voltage(V): 220	Luminary EER(lm/W): 55.806	Up Lumens&Percent: 23.561lm 3.00%	
Tested Power(W): 14.050	Max. Candela(cd): 2816.029	S/MH: C0_a180=0.463 C90_270=0.459	
Lamps' Inside: 1	Max Cand@Ang.(°): C=0.0 γ=1.0	CIE Type: Semi-Direct	
Tested Electrics(V, A, pf):220.5, 0.109, 0.582	Beam Angle(50%Imax): 27.3(°)	ErP Φuse(90°): 734.274lm	
Lamp Size(W*L*H):0.066m*0.066m*0.000m	Left=-13.3°, Right=13.9°	IRF(%): 774.518	

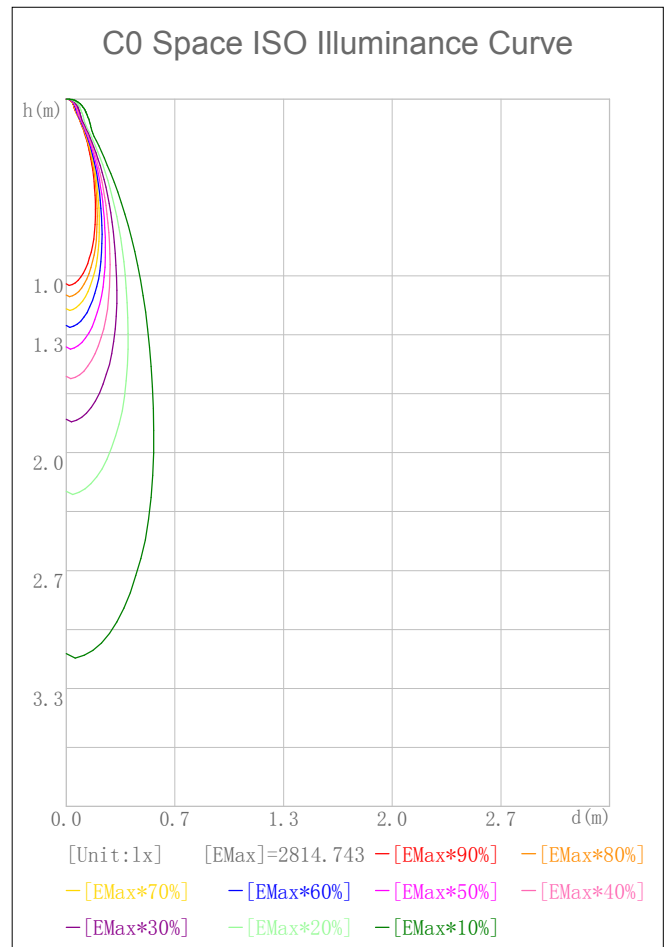
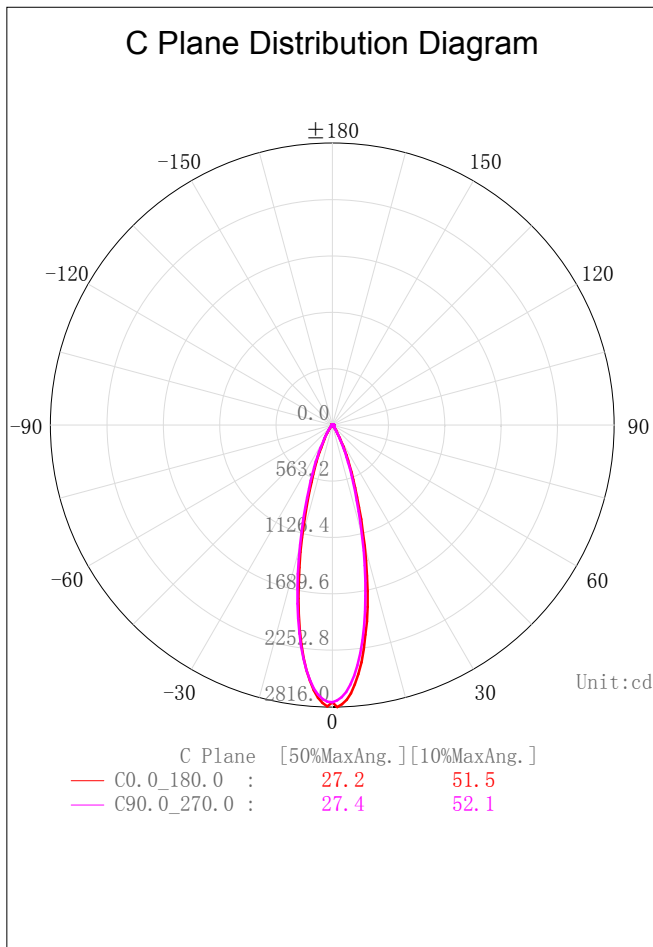

IES Indoor Report

Photometric Filename:AW12540 15W 1204C9 3090 ZHT35-24D 350.IES

2D Plane Light Intensity Distribution Curve

Lum. Name: AW12540	Lum. Catalog: Down Light	Test ID:
Lamp Name: 1204C9	Lamp Catalog: COB	Test Lab: Test
Manufacture: -	Test Machine:GON-2000	Test Date: 2023/06/30

C Plane Distribution Diagram

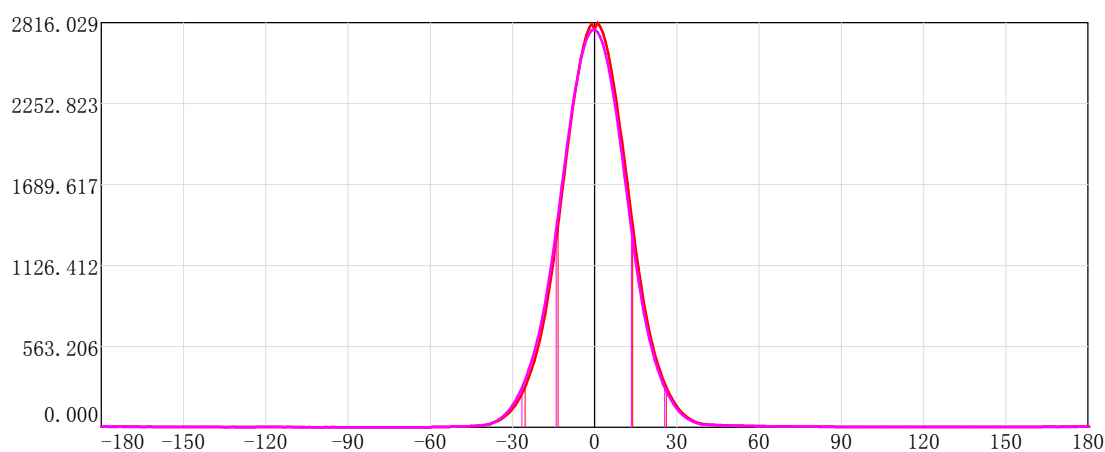
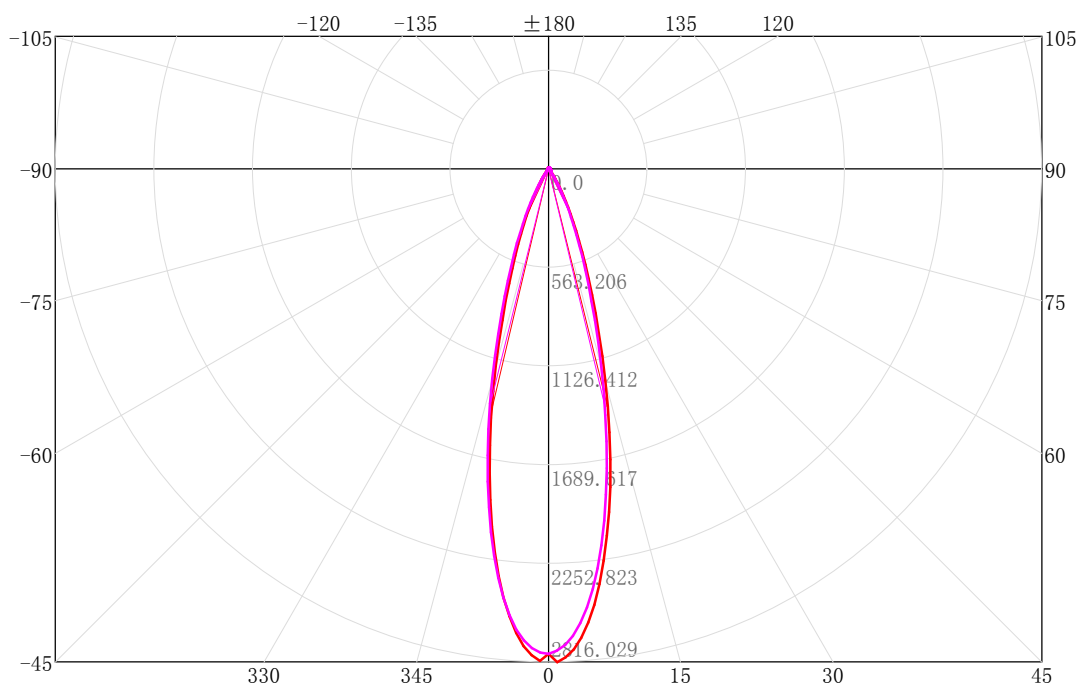

	C Plane	[50%MaxAng.]	[10%MaxAng.]	Unit:cd
—	C0.0_180.0 :	27.3	51.5	
—	C90.0_270.0 :	27.4	52.1	

IES Indoor Report

Photometric Filename:AW12540 15W 1204C9 3090 ZHT35-24D 350.IES

3D Light Intensity Distribution Modal

Lum. Name: AW12540	Lum. Catalog: Down Light	Test ID:
Lamp Name: 1204C9	Lamp Catalog: COB	Test Lab: Test
Manufacture: -	Test Machine: GON-2000	Test Date: 2023/06/30

3D Light Intensity Distribution Modal

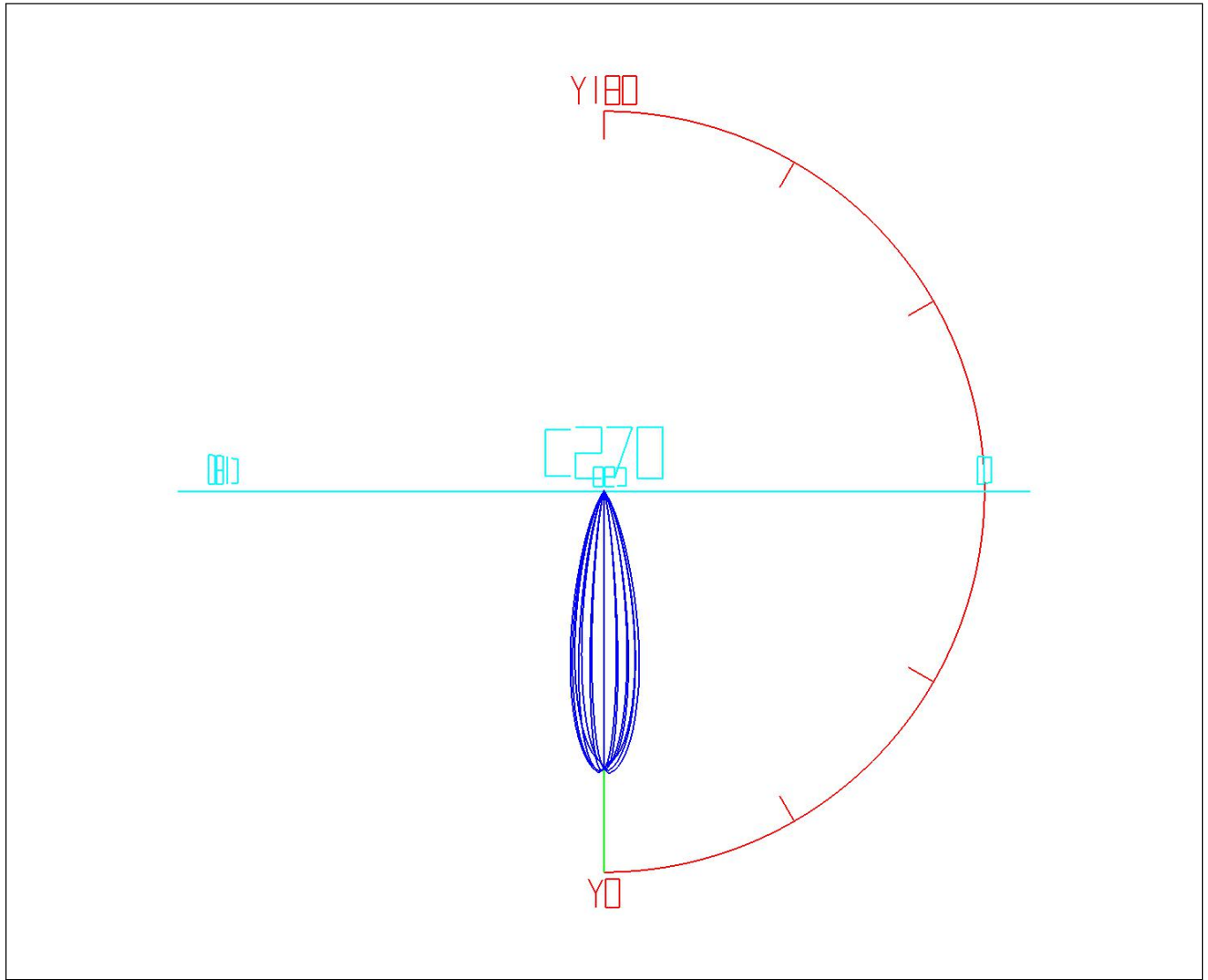

Curves: 3D Model ——— Fixture ——— Vert. HUD ——— Hori. HUD ———
View Angles: Orient:0 Tilt:0 Roll:0 Spin:0

IES Indoor Report

Photometric Filename:AW12540 15W 1204C9 3090 ZHT35-24D 350.IES

Zonal Flux Tabulation

Zone (γ)	Zone Flux (lm)	Sums Flux (lm)	Zone%Lamp	Sums%Lamp	Zone (γ)	Zone Flux (lm)	Sums Flux (lm)	Zone%Lamp	Sums%Lamp
0.0-1.0	2.64	2.64	0.34	0.34	47.0-48.0	0.95	737.73	0.12	94.10
1.0-2.0	7.88	10.52	1.00	1.34	48.0-49.0	0.92	738.64	0.12	94.21
2.0-3.0	12.95	23.47	1.65	2.99	49.0-50.0	0.88	739.52	0.11	94.33
3.0-4.0	17.75	41.22	2.26	5.26	50.0-51.0	0.83	740.35	0.11	94.43
4.0-5.0	22.16	63.38	2.83	8.08	51.0-52.0	0.79	741.14	0.10	94.53
5.0-6.0	26.11	89.49	3.33	11.41	52.0-53.0	0.74	741.88	0.09	94.63
6.0-7.0	29.51	119.01	3.76	15.18	53.0-54.0	0.71	742.59	0.09	94.72
7.0-8.0	32.31	151.32	4.12	19.30	54.0-55.0	0.68	743.27	0.09	94.81
8.0-9.0	34.45	185.77	4.39	23.69	55.0-56.0	0.66	743.94	0.08	94.89
9.0-10.0	35.95	221.71	4.59	28.28	56.0-57.0	0.65	744.58	0.08	94.97
10.0-11.0	36.80	258.52	4.69	32.97	57.0-58.0	0.64	745.22	0.08	95.05
11.0-12.0	37.02	295.54	4.72	37.70	58.0-59.0	0.62	745.84	0.08	95.13
12.0-13.0	36.64	332.18	4.67	42.37	59.0-60.0	0.61	746.46	0.08	95.21
13.0-14.0	35.74	367.92	4.56	46.93	60.0-61.0	0.60	747.06	0.08	95.29
14.0-15.0	34.41	402.33	4.39	51.32	61.0-62.0	0.59	747.65	0.08	95.36
15.0-16.0	32.73	435.06	4.17	55.49	62.0-63.0	0.58	748.23	0.07	95.44
16.0-17.0	30.78	465.84	3.93	59.42	63.0-64.0	0.56	748.79	0.07	95.51
17.0-18.0	28.70	494.54	3.66	63.08	64.0-65.0	0.54	749.33	0.07	95.58
18.0-19.0	26.61	521.14	3.39	66.47	65.0-66.0	0.52	749.85	0.07	95.64
19.0-20.0	24.54	545.68	3.13	69.60	66.0-67.0	0.50	750.35	0.06	95.71
20.0-21.0	22.53	568.21	2.87	72.48	67.0-68.0	0.49	750.84	0.06	95.77
21.0-22.0	20.59	588.80	2.63	75.10	68.0-69.0	0.48	751.32	0.06	95.83
22.0-23.0	18.70	607.51	2.39	77.49	69.0-70.0	0.47	751.79	0.06	95.89
23.0-24.0	16.87	624.38	2.15	79.64	70.0-71.0	0.47	752.26	0.06	95.95
24.0-25.0	15.12	639.50	1.93	81.57	71.0-72.0	0.46	752.72	0.06	96.01
25.0-26.0	13.49	652.99	1.72	83.29	72.0-73.0	0.46	753.18	0.06	96.07
26.0-27.0	11.97	664.95	1.53	84.82	73.0-74.0	0.45	753.64	0.06	96.13
27.0-28.0	10.56	675.51	1.35	86.16	74.0-75.0	0.45	754.09	0.06	96.18
28.0-29.0	9.24	684.75	1.18	87.34	75.0-76.0	0.45	754.54	0.06	96.24
29.0-30.0	8.02	692.77	1.02	88.36	76.0-77.0	0.44	754.98	0.06	96.30
30.0-31.0	6.89	699.66	0.88	89.24	77.0-78.0	0.44	755.42	0.06	96.35
31.0-32.0	5.88	705.54	0.75	89.99	78.0-79.0	0.43	755.85	0.06	96.41
32.0-33.0	4.99	710.53	0.64	90.63	79.0-80.0	0.43	756.28	0.05	96.46
33.0-34.0	4.21	714.74	0.54	91.17	80.0-81.0	0.43	756.71	0.05	96.52
34.0-35.0	3.55	718.29	0.45	91.62	81.0-82.0	0.43	757.13	0.05	96.57
35.0-36.0	2.98	721.27	0.38	92.00	82.0-83.0	0.43	757.56	0.05	96.63
36.0-37.0	2.49	723.76	0.32	92.32	83.0-84.0	0.43	757.99	0.05	96.68
37.0-38.0	2.06	725.82	0.26	92.58	84.0-85.0	0.43	758.41	0.05	96.74
38.0-39.0	1.71	727.52	0.22	92.80	85.0-86.0	0.42	758.84	0.05	96.79
39.0-40.0	1.46	728.98	0.19	92.98	86.0-87.0	0.42	759.26	0.05	96.84
40.0-41.0	1.30	730.28	0.17	93.15	87.0-88.0	0.42	759.68	0.05	96.90
41.0-42.0	1.20	731.48	0.15	93.30	88.0-89.0	0.42	760.10	0.05	96.95
42.0-43.0	1.14	732.62	0.15	93.45	89.0-90.0	0.42	760.51	0.05	97.00
43.0-44.0	1.09	733.72	0.14	93.59	90.0-91.0	0.41	760.93	0.05	97.06
44.0-45.0	1.05	734.77	0.13	93.72	91.0-92.0	0.41	761.33	0.05	97.11
45.0-46.0	1.02	735.79	0.13	93.85	92.0-93.0	0.41	761.74	0.05	97.16
46.0-47.0	0.99	736.77	0.13	93.98	93.0-94.0	0.40	762.14	0.05	97.21

IES Indoor Report

Photometric Filename:AW12540 15W 1204C9 3090 ZHT35-24D 350.IES

Zonal Flux Tabulation - (Cont.)

Zone (γ)	Zone Flux (lm)	Sums Flux (lm)	Zone%Lamp	Sums%Lamp	Zone (γ)	Zone Flux (lm)	Sums Flux (lm)	Zone%Lamp	Sums%Lamp
94.0-95.0	0.40	762.55	0.05	97.26	141.0-142.0	0.25	777.84	0.03	99.21
95.0-96.0	0.40	762.95	0.05	97.32	142.0-143.0	0.25	778.08	0.03	99.25
96.0-97.0	0.40	763.35	0.05	97.37	143.0-144.0	0.24	778.33	0.03	99.28
97.0-98.0	0.39	763.74	0.05	97.42	144.0-145.0	0.24	778.57	0.03	99.31
98.0-99.0	0.39	764.14	0.05	97.47	145.0-146.0	0.24	778.81	0.03	99.34
99.0-100.0	0.40	764.53	0.05	97.52	146.0-147.0	0.24	779.04	0.03	99.37
100.0-101.0	0.39	764.92	0.05	97.57	147.0-148.0	0.24	779.28	0.03	99.40
101.0-102.0	0.38	765.31	0.05	97.62	148.0-149.0	0.24	779.52	0.03	99.43
102.0-103.0	0.38	765.69	0.05	97.66	149.0-150.0	0.24	779.76	0.03	99.46
103.0-104.0	0.38	766.07	0.05	97.71	150.0-151.0	0.24	779.99	0.03	99.49
104.0-105.0	0.38	766.45	0.05	97.76	151.0-152.0	0.24	780.23	0.03	99.52
105.0-106.0	0.38	766.83	0.05	97.81	152.0-153.0	0.23	780.46	0.03	99.55
106.0-107.0	0.37	767.20	0.05	97.86	153.0-154.0	0.23	780.69	0.03	99.58
107.0-108.0	0.37	767.57	0.05	97.90	154.0-155.0	0.23	780.93	0.03	99.61
108.0-109.0	0.36	767.93	0.05	97.95	155.0-156.0	0.23	781.16	0.03	99.64
109.0-110.0	0.36	768.29	0.05	98.00	156.0-157.0	0.22	781.38	0.03	99.67
110.0-111.0	0.36	768.65	0.05	98.04	157.0-158.0	0.21	781.59	0.03	99.69
111.0-112.0	0.35	769.00	0.05	98.09	158.0-159.0	0.20	781.79	0.03	99.72
112.0-113.0	0.35	769.35	0.04	98.13	159.0-160.0	0.20	781.99	0.03	99.74
113.0-114.0	0.35	769.70	0.04	98.18	160.0-161.0	0.19	782.18	0.02	99.77
114.0-115.0	0.34	770.04	0.04	98.22	161.0-162.0	0.18	782.36	0.02	99.79
115.0-116.0	0.34	770.38	0.04	98.26	162.0-163.0	0.18	782.54	0.02	99.81
116.0-117.0	0.34	770.72	0.04	98.31	163.0-164.0	0.17	782.71	0.02	99.84
117.0-118.0	0.33	771.06	0.04	98.35	164.0-165.0	0.16	782.88	0.02	99.86
118.0-119.0	0.33	771.38	0.04	98.39	165.0-166.0	0.15	783.03	0.02	99.88
119.0-120.0	0.32	771.71	0.04	98.43	166.0-167.0	0.14	783.17	0.02	99.89
120.0-121.0	0.32	772.02	0.04	98.47	167.0-168.0	0.13	783.30	0.02	99.91
121.0-122.0	0.32	772.34	0.04	98.51	168.0-169.0	0.12	783.43	0.02	99.93
122.0-123.0	0.31	772.65	0.04	98.55	169.0-170.0	0.11	783.54	0.01	99.94
123.0-124.0	0.31	772.96	0.04	98.59	170.0-171.0	0.10	783.64	0.01	99.95
124.0-125.0	0.31	773.27	0.04	98.63	171.0-172.0	0.09	783.73	0.01	99.97
125.0-126.0	0.30	773.57	0.04	98.67	172.0-173.0	0.08	783.81	0.01	99.98
126.0-127.0	0.29	773.86	0.04	98.71	173.0-174.0	0.07	783.88	0.01	99.98
127.0-128.0	0.29	774.15	0.04	98.74	174.0-175.0	0.06	783.94	0.01	99.99
128.0-129.0	0.28	774.43	0.04	98.78	175.0-176.0	0.05	783.99	0.01	100.00
129.0-130.0	0.28	774.71	0.04	98.81	176.0-177.0	0.04	784.03	0.00	100.00
130.0-131.0	0.28	774.99	0.04	98.85	177.0-178.0	0.03	784.05	0.00	100.01
131.0-132.0	0.27	775.26	0.03	98.89	178.0-179.0	0.02	784.07	0.00	100.01
132.0-133.0	0.27	775.53	0.03	98.92	179.0-180.0	0.01	784.07	0.00	100.01
133.0-134.0	0.27	775.80	0.03	98.95					
134.0-135.0	0.26	776.06	0.03	98.99					
135.0-136.0	0.26	776.33	0.03	99.02					
136.0-137.0	0.26	776.59	0.03	99.05					
137.0-138.0	0.26	776.84	0.03	99.09					
138.0-139.0	0.25	777.09	0.03	99.12					
139.0-140.0	0.25	777.34	0.03	99.15					
140.0-141.0	0.25	777.59	0.03	99.18					

IES Indoor Report

Photometric Filename:AW12540 15W 1204C9 3090 ZHT35-24D 350.IES

Rectangle ISO Lighting Intensity Diagram

Lum. Name: AW12540	Lum. Catalog: Down Light	Test ID:
Lamp Name: 1204C9	Lamp Catalog: COB	Test Lab: Test
Manufacture: -	Test Machine: GON-2000	Test Date: 2023/06/30

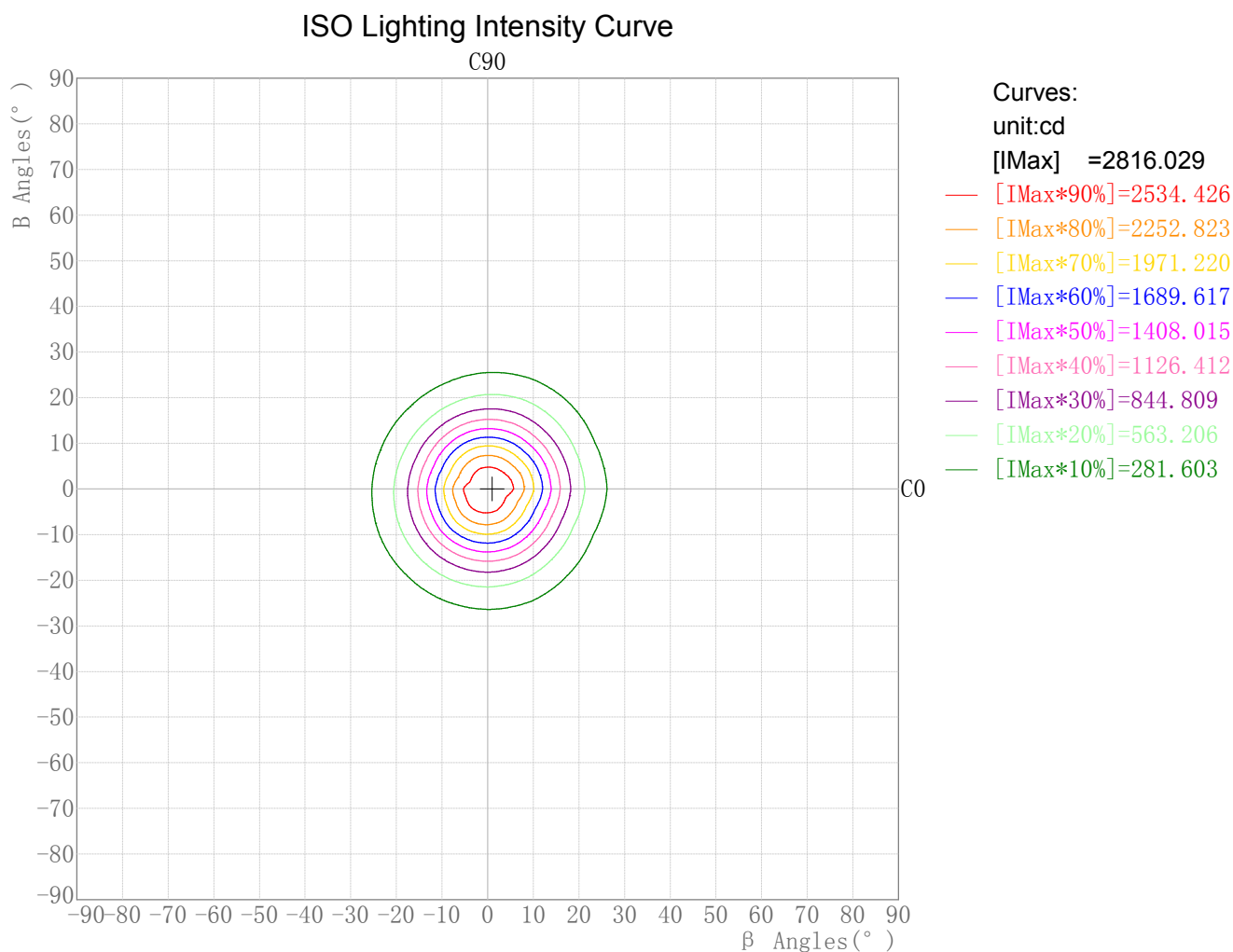

Maximum Light Intensity(cd): 2816.03
Maximum Cand.@Angle: H=1.0°,V=0.0°

IES Indoor Report

Photometric Filename:AW12540 15W 1204C9 3090 ZHT35-24D 350.IES

Round ISO Lighting Intensity Diagram

Lum. Name: AW12540	Lum. Catalog: Down Light	Test ID:
Lamp Name: 1204C9	Lamp Catalog: COB	Test Lab: Test
Manufacture: -	Test Machine: GON-2000	Test Date: 2023/06/30

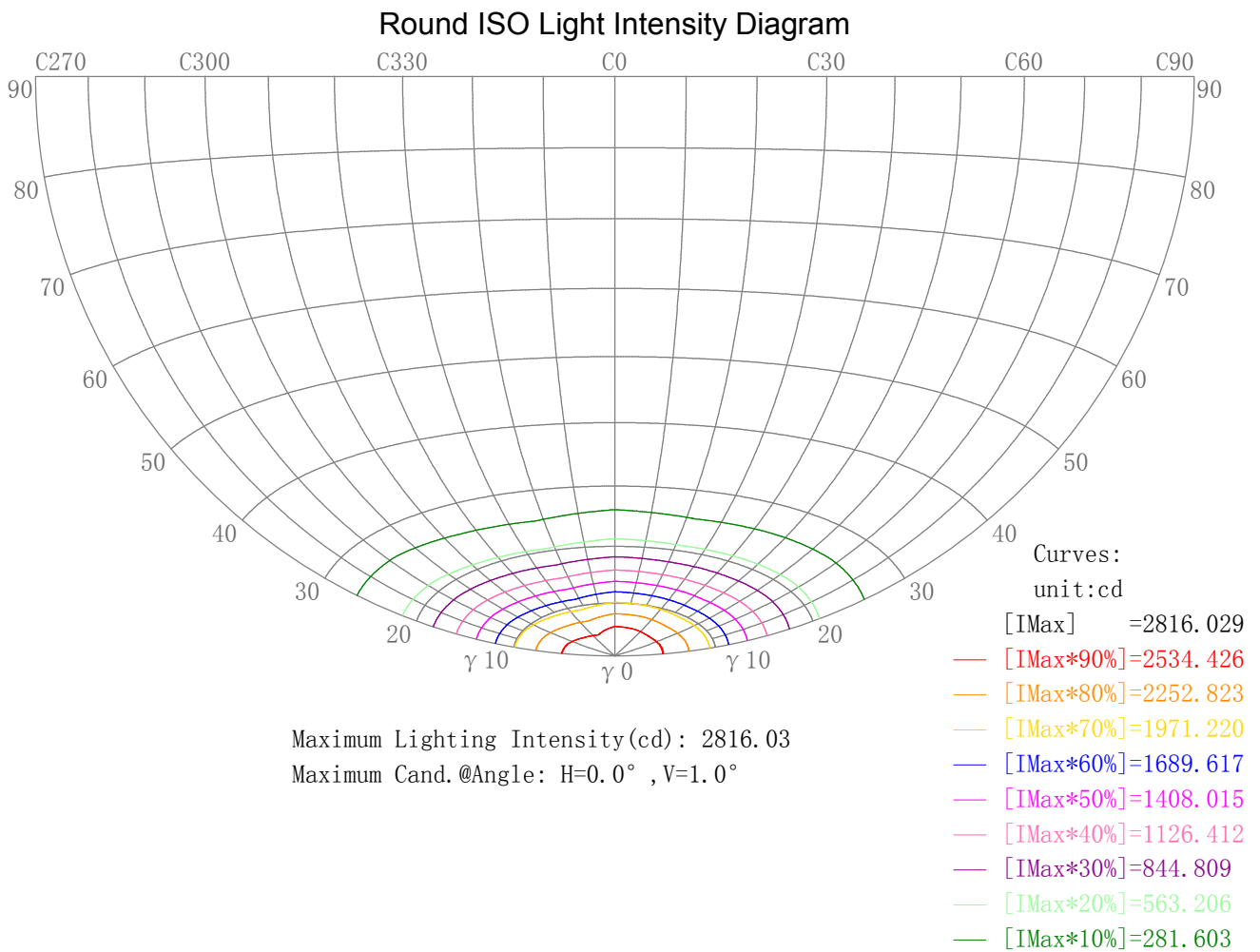

IES Indoor Report

Photometric Filename:AW12540 15W 1204C9 3090 ZHT35-24D 350.IES

Plane ISO-Illuminance Diagram

Lum. Name: AW12540	Lum. Catalog: Down Light	Test ID:
Lamp Name: 1204C9	Lamp Catalog: COB	Test Lab: Test
Manufacture: -	Test Machine: GON-2000	Test Date: 2023/06/30

Plane ISO-Illuminance Curve

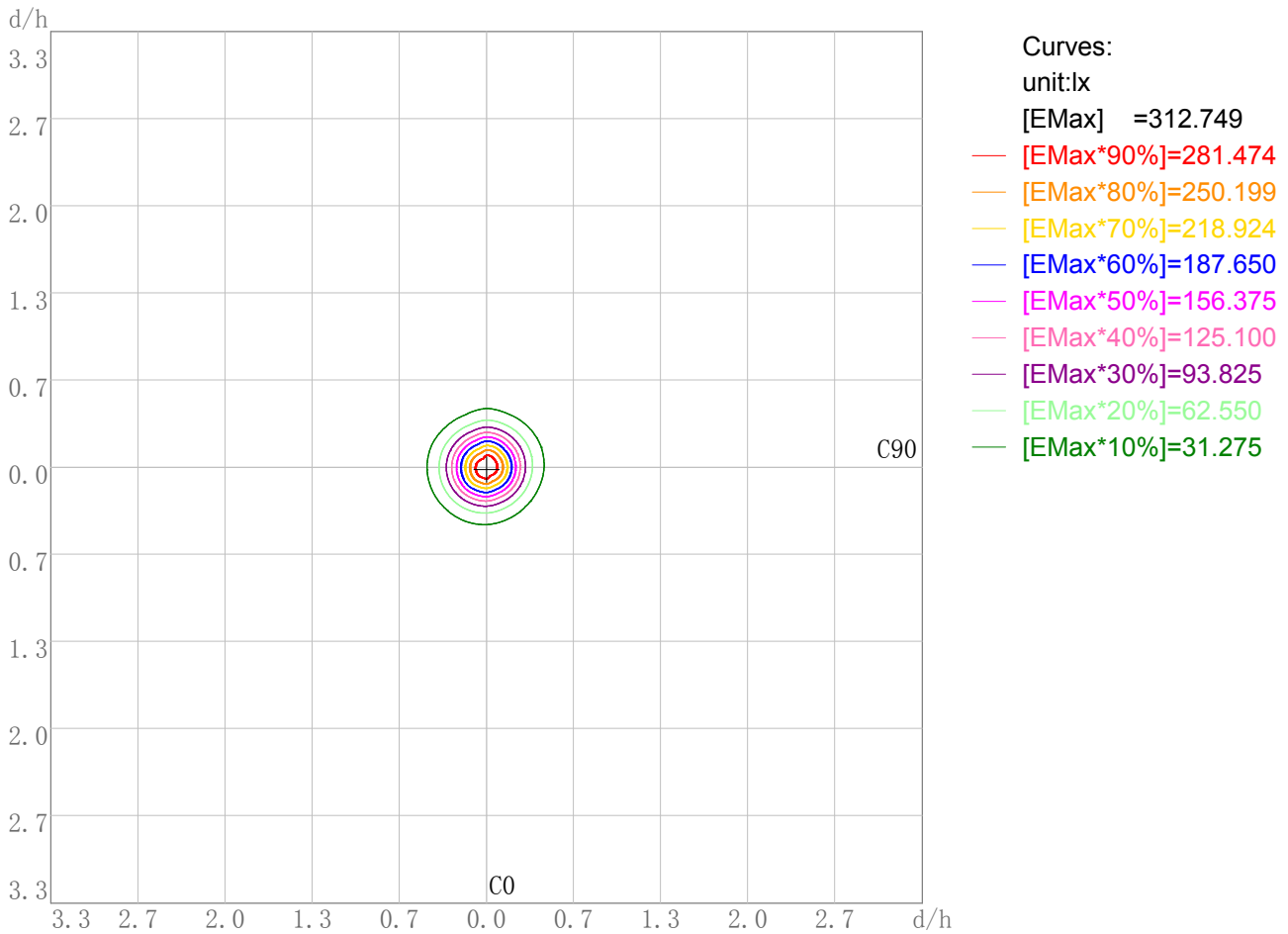

Working Plane Luminaire Mounting Height(m): 3.00
Working Plane Maximum Illuminance(lx): 312.75
Working Plane Maximum Illuminance Position(d/h):H0.0 V0.0

IES Indoor Report

Photometric Filename:AW12540 15W 1204C9 3090 ZHT35-24D 350.IES

3D Plane ISO Illuminance Diagram

Lum. Name: AW12540	Lum. Catalog: Down Light	Test ID:
Lamp Name: 1204C9	Lamp Catalog: COB	Test Lab: Test
Manufacture: -	Test Machine: GON-2000	Test Date: 2023/06/30

3D Plane Illuminance Modal

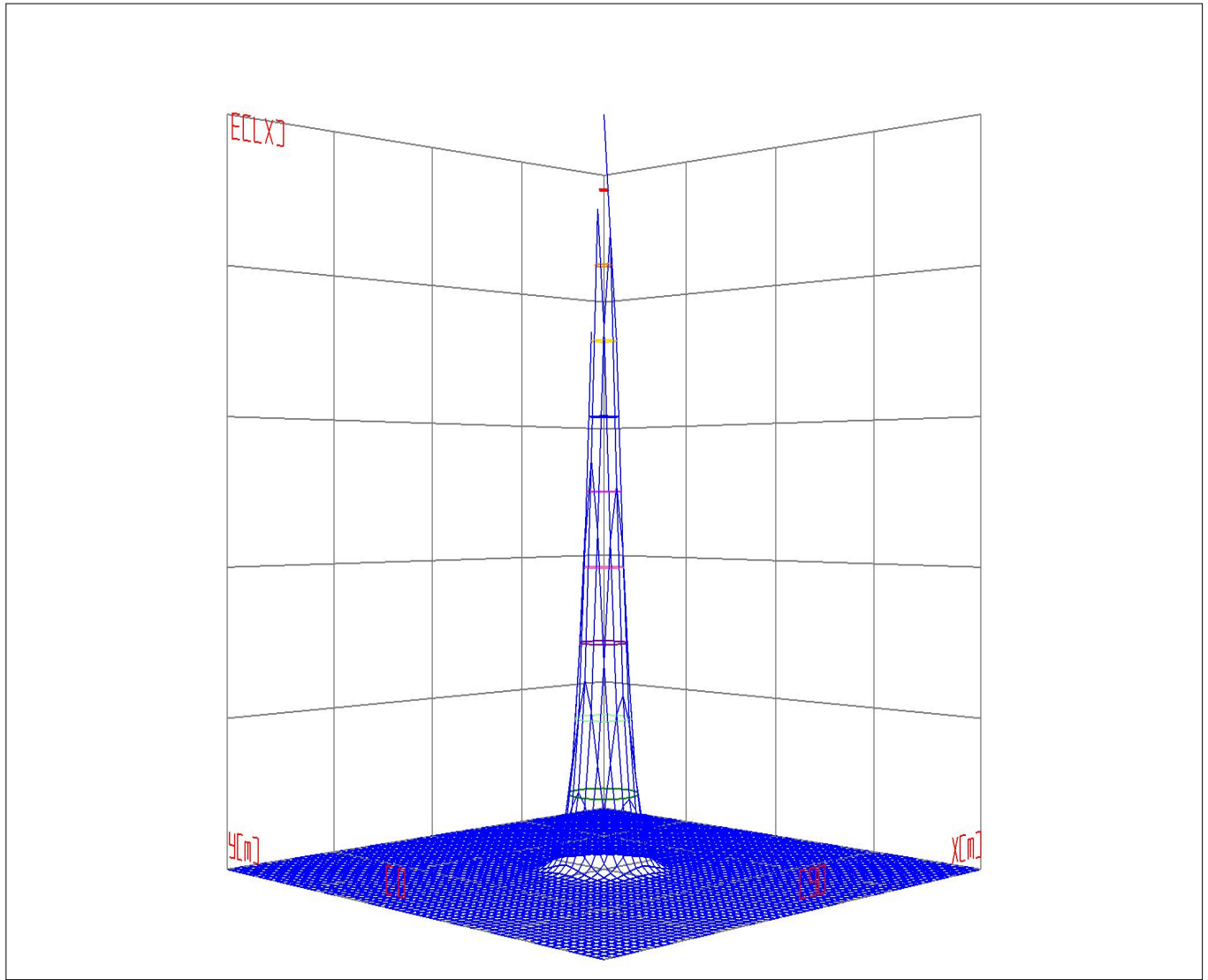

Curves: 3D Model — 90% — 80% — 70% — 60% — 50% — 40% — 30% — 20% — 10% —
View Angles(deg): 0 Height(m): 3.0 Distance(m): 10.0

IES Indoor Report

Photometric Filename:AW12540 15W 1204C9 3090 ZHT35-24D 350.IES

Space ISO Illuminance Diagram

Lum. Name: AW12540	Lum. Catalog: Down Light	Test ID:
Lamp Name: 1204C9	Lamp Catalog: COB	Test Lab: Test
Manufacture: -	Test Machine: GON-2000	Test Date: 2023/06/30

Space ISO Illuminance Curve

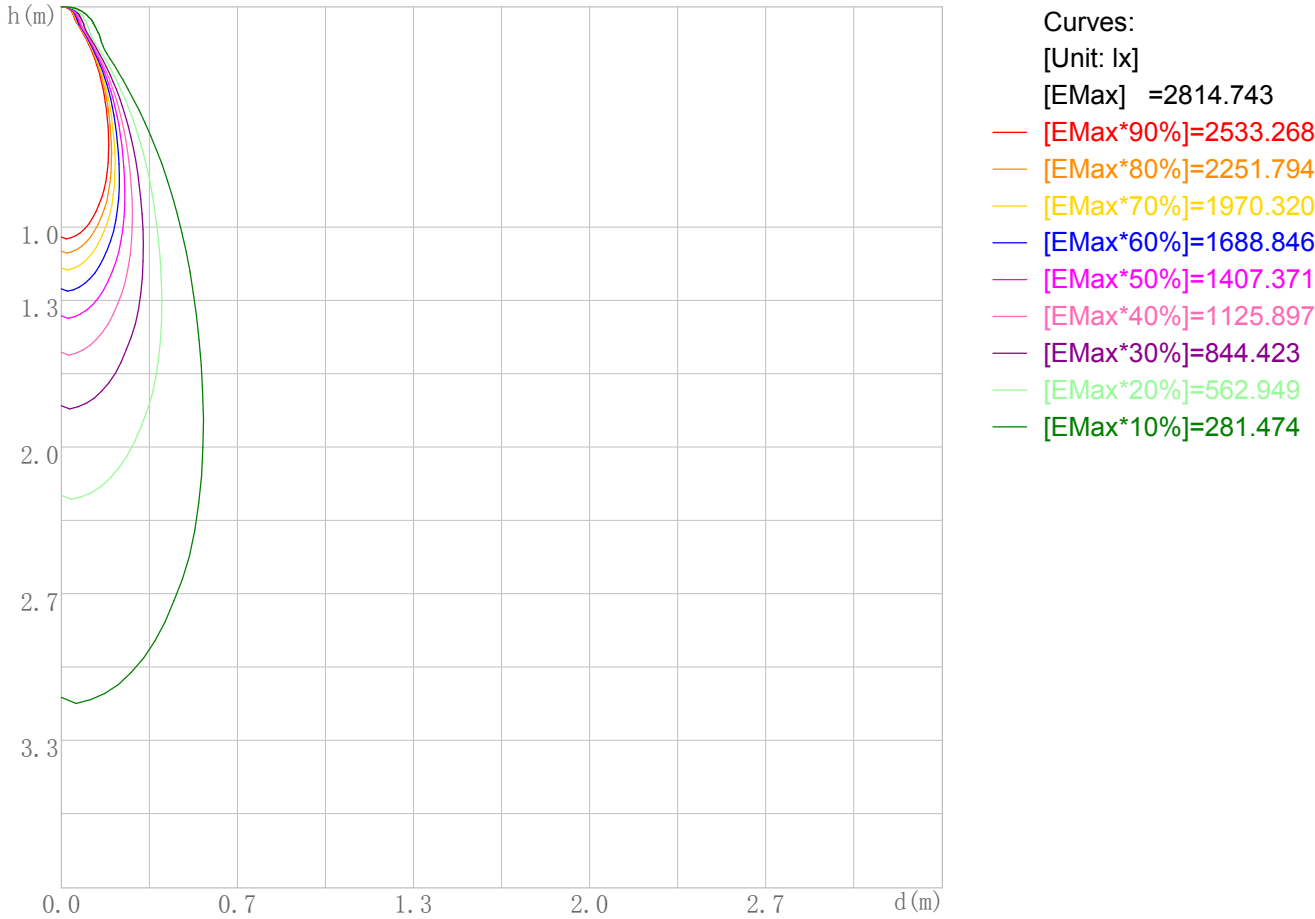

Space Plane Maximum Illuminance and @Angle:2814.74lx,1.0deg
Plane Maximum Lighting Intensity and @Angle:2816.029cd,0deg

IES Indoor Report

Photometric Filename:AW12540 15W 1204C9 3090 ZHT35-24D 350.IES

Illuminance-Distance Diagram

Lum. Name: AW12540	Lum. Catalog: Down Light	Test ID:
Lamp Name: 1204C9	Lamp Catalog: COB	Test Lab: Test
Manufacture: -	Test Machine: GON-2000	Test Date: 2023/06/30

Illuminance-Distance Curve

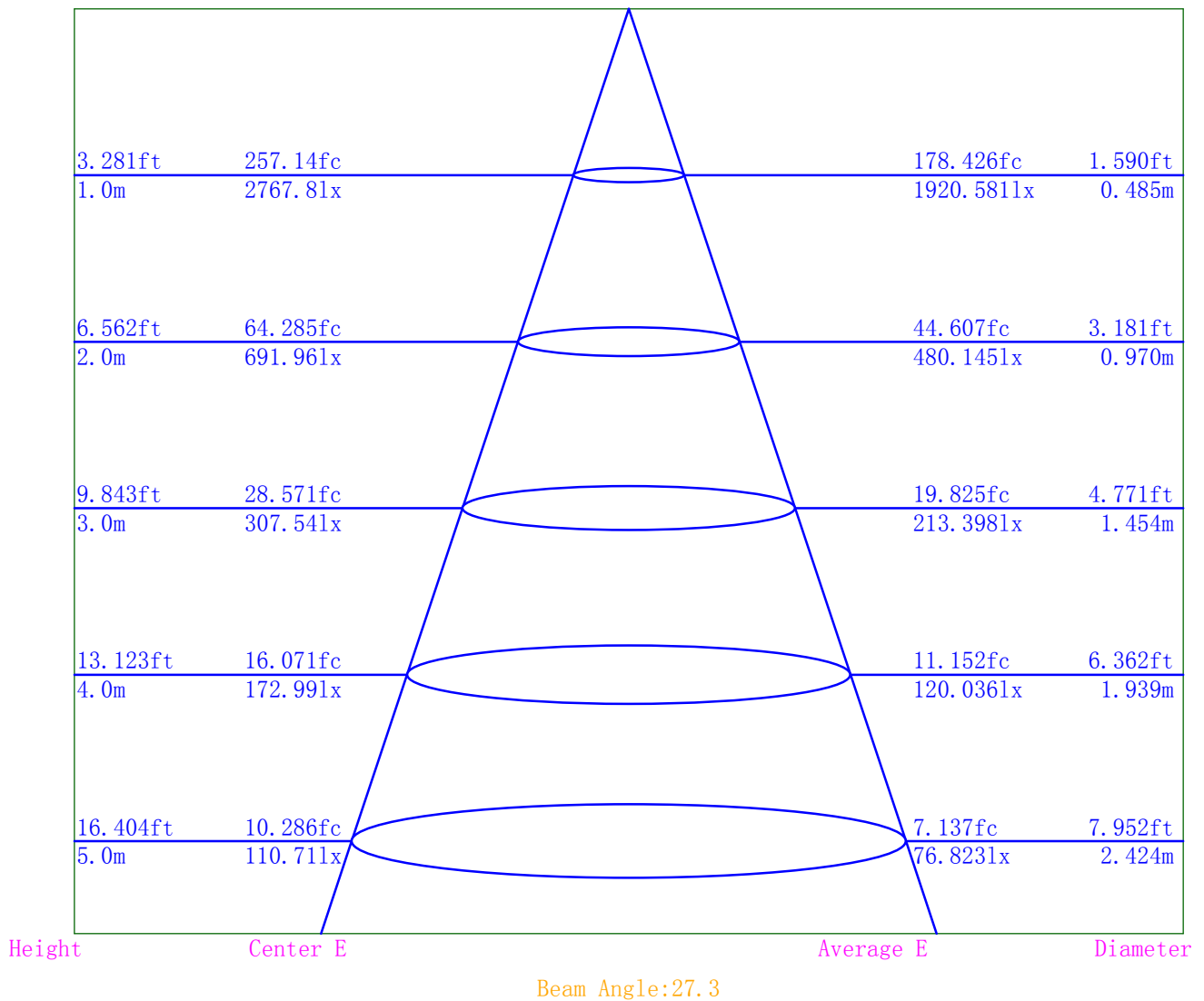

IES Indoor Report

Photometric Filename:AW12540 15W 1204C9 3090 ZHT35-24D 350.IES

Indoor Luminance Limiting Curves

Lum. Name: AW12540	Lum. Catalog: Down Light	Test ID:
Lamp Name: 1204C9	Lamp Catalog: COB	Test Lab: Test
Manufacture: -	Test Machine:GON-2000	Test Date: 2023/06/30

Glare Grade Table

GI	Quality	Using Illuminance							
		a	b	c	d	e	f	g	h
1.15	A	2000	1000	500	<=300				
1.5	B		2000	1000	500	<=300			
1.85	C			2000	1000	500	<=300		
2.2	D				2000	1000	500	<=300	
2.55	E	a				2000	1000	500	<=300
			b	c	d	e	f	g	h

Luminance Table

Gama(deg)	45	50	55	60	65	70	75	80	85
C0	7271	6524	6056	6122	6255	6881	7897	10542	19223
C90	6598	6185	5426	5599	5635	6054	7141	10179	17721

Luminance Limiting Curve

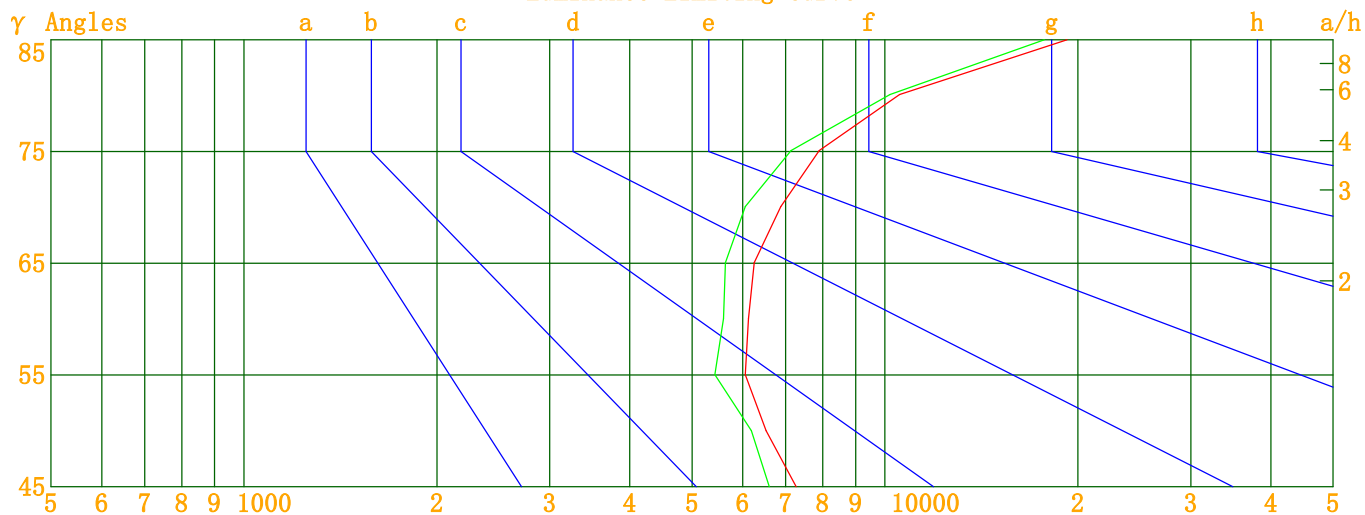

Luminous Size: Length(m)=-0.066 Width(m)=-0.066 Height(m)=0.000 Area(m^2)=0.003421
 Luminous Type: Without Luminous Side
 Luminous Curves: C0-C180 Color: — C90-C270 Color: —

IES Indoor Report

Photometric Filename:AW12540 15W 1204C9 3090 ZHT35-24D 350.IES

Indoor Budgetary Estimate Table

Lum. Name: AW12540	Lum. Catalog: Down Light	Test ID:
Lamp Name: 1204C9	Lamp Catalog: COB	Test Lab: Test
Manufacture: -	Test Machine: GON-2000	Test Date: 2023/06/30

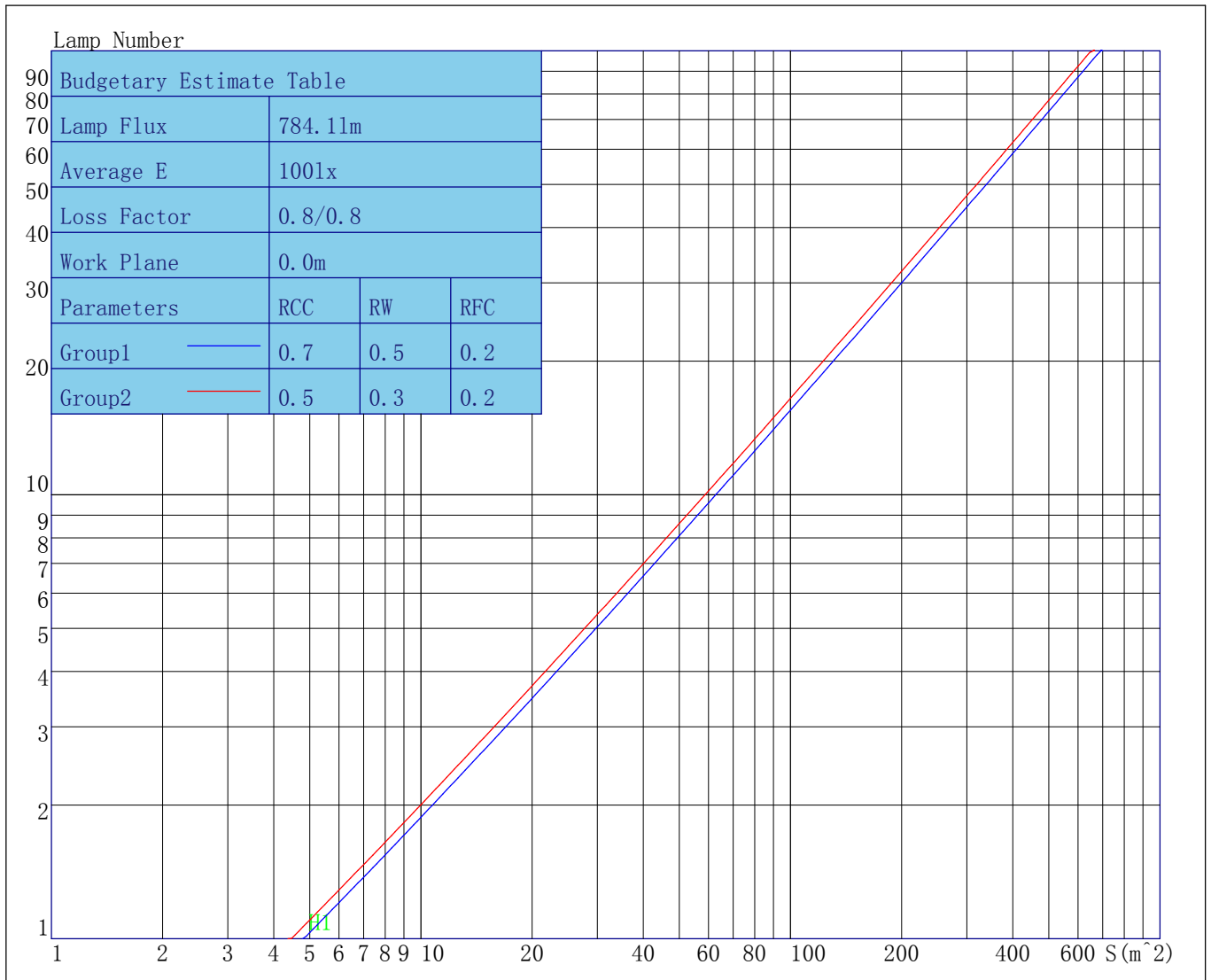

Parameters1: Rhocc = 0.7 Rhow = 0.5 Rhofc = 0.2 LLF = 0.8
 Parameters2: Rhocc = 0.5 Rhow = 0.3 Rhofc = 0.2 LLF = 0.8
 Average Illuminance(lx): 100 Cavity Height: H1(m) = 2

IES Indoor Report

Photometric Filename:AW12540 15W 1204C9 3090 ZHT35-24D 350.IES

Indoor Coefficient of Utilization Table

Lum. Name: AW12540	Lum. Catalog: Down Light	Test ID:
Lamp Name: 1204C9	Lamp Catalog: COB	Test Lab: Test
Manufacture: -	Test Machine:GON-2000	Test Date: 2023/06/30

Coefficients of Utilization - Zonal Cavity Method																		
Coef.	Effective Floor Cavity Reflectance RFC=0.20																	
RhoCC (%)	80				70				50			30			10			0
RhoW (%)	70	50	30	10	70	50	30	10	50	30	10	50	30	10	50	30	10	0
RCR	Coefficient of Utilization(%)																	
0	118	118	118	118	115	115	115	115	109	109	109	104	104	104	99	99	99	97
1	114	111	109	107	111	109	107	105	104	103	101	100	99	98	96	95	94	92
2	109	105	102	99	107	103	100	97	99	97	95	96	94	92	93	91	90	88
3	105	100	96	92	103	98	94	91	95	92	90	93	90	88	90	88	86	85
4	101	95	91	87	99	94	90	87	91	88	85	89	86	84	87	85	83	81
5	98	91	86	83	96	90	86	83	88	84	82	86	83	81	84	82	80	78
6	94	87	83	79	93	87	82	79	85	81	78	83	80	78	82	79	77	76
7	91	84	79	76	90	83	79	76	82	78	75	81	77	75	79	76	74	73
8	88	81	76	73	87	80	76	73	79	75	73	78	75	72	77	74	72	71
9	86	78	74	71	85	78	73	70	77	73	70	76	72	70	75	72	69	68
10	83	76	71	68	82	75	71	68	74	70	68	73	70	68	73	70	67	66

IES Indoor Report

Photometric Filename:AW12540 15W 1204C9 3090 ZHT35-24D 350.IES

Unified Glare Rating Table

Lum. Name: AW12540	Lum. Catalog: Down Light	Test ID:
Lamp Name: 1204C9	Lamp Catalog: COB	Test Lab: Test
Manufacture: -	Test Machine:GON-2000	Test Date: 2023/06/30

Unified Glare Rating Table

Ceiling RCC	0.70	0.70	0.50	0.50	0.30	0.70	0.70	0.50	0.50	0.30	
Wall RW	0.50	0.30	0.50	0.30	0.30	0.50	0.30	0.50	0.30	0.30	
Floor RFC	0.20	0.20	0.20	0.20	0.20	0.20	0.20	0.20	0.20	0.20	
Room Size	Vewed crosswise					Vewed endwise					
X=2H	Y=2H	11.5	12.4	11.9	12.8	13.2	11.9	12.8	12.3	13.2	13.6
	Y=3H	12.7	13.5	13.2	13.9	14.4	13.2	14.0	13.6	14.4	14.9
	Y=4H	13.7	14.4	14.2	14.9	15.3	14.1	14.8	14.6	15.3	15.7
	Y=6H	14.9	15.6	15.4	16.1	16.5	15.2	15.9	15.7	16.4	16.8
	Y=8H	15.7	16.4	16.2	16.8	17.3	15.9	16.5	16.4	17.0	17.5
	Y=12H	16.7	17.3	17.2	17.8	18.3	16.7	17.3	17.2	17.8	18.3
X=4H	Y=2H	11.6	12.4	12.1	12.8	13.2	12.3	13.0	12.7	13.4	13.9
	Y=3H	13.1	13.7	13.6	14.2	14.7	13.9	14.5	14.4	15.0	15.5
	Y=4H	14.2	14.8	14.7	15.3	15.8	15.0	15.6	15.5	16.0	16.6
	Y=6H	15.7	16.2	16.3	16.7	17.3	16.4	16.9	16.9	17.4	17.9
	Y=8H	16.7	17.1	17.2	17.6	18.2	17.2	17.6	17.7	18.1	18.7
	Y=12H	17.8	18.2	18.4	18.8	19.3	18.1	18.5	18.7	19.1	19.6
X=8H	Y=4H	14.5	15.0	15.0	15.5	16.0	15.4	15.9	16.0	16.4	16.9
	Y=6H	16.2	16.6	16.8	17.1	17.7	17.1	17.4	17.7	18.0	18.6
	Y=8H	17.3	17.6	17.9	18.2	18.8	18.1	18.4	18.7	19.0	19.5
	Y=12H	18.7	19.0	19.3	19.6	20.2	19.3	19.6	19.9	20.1	20.8
X=12H	Y=4H	14.6	14.9	15.1	15.5	16.0	15.5	15.9	16.1	16.5	17.0
	Y=6H	16.4	16.7	17.0	17.2	17.8	17.3	17.6	17.9	18.1	18.7
	Y=8H	17.6	17.8	18.1	18.4	19.0	18.4	18.7	19.0	19.2	19.9
Variations with the objverer position at spacings											
S=1.0H	0.1/-0.0					0.1/-0.1					
S=1.5H	0.1/-0.2					0.1/-0.1					
S=2.0H	0.2/-0.5					0.1/-0.1					
Reduced UGR Table:											
Nordic Standard Table:	BKO					BKO					
Correction Value	4.4					4.6					

o the CIE Pub. 117, data has been corrected, refers to the lamp's lumens 8.2flm.

IES Indoor Report

Photometric Filename:AW12540 15W 1204C9 3090 ZHT35-24D 350.IES

Candela Tabulation

V/H	C0.0	C22.5	C45.0	C67.5	C90.0	C112.5	C135.0	C157.5	C180.0	C202.5	C225.0	C247.5
γ 0.0	2767.83	2767.83	2767.83	2767.83	2767.83	2767.83	2767.83	2767.83	2767.83	2767.83	2767.83	2767.83
γ 1.0	2816.03	2792.05	2770.14	2760.71	2750.75	2746.05	2715.81	2693.05	2810.00	2786.49	2782.86	2773.12
γ 2.0	2790.23	2767.07	2739.33	2727.67	2719.14	2714.86	2687.24	2663.85	2777.71	2754.39	2759.85	2749.72
γ 3.0	2747.04	2723.58	2687.19	2677.50	2669.46	2668.43	2638.22	2614.90	2727.86	2704.38	2716.21	2708.51
γ 4.0	2683.99	2659.54	2616.44	2607.32	2599.31	2597.43	2569.31	2544.84	2656.09	2634.95	2656.62	2650.07
γ 5.0	2599.16	2577.97	2530.94	2520.79	2513.46	2511.66	2484.60	2458.98	2564.82	2546.09	2577.48	2570.08
γ 6.0	2501.88	2480.94	2428.91	2419.86	2412.98	2412.44	2383.33	2357.14	2460.96	2442.84	2479.05	2474.61
γ 7.0	2387.25	2367.87	2312.59	2304.25	2297.50	2295.17	2267.19	2240.30	2341.39	2325.74	2369.95	2366.63
γ 8.0	2258.86	2240.58	2184.29	2176.22	2169.84	2166.65	2138.93	2111.65	2208.30	2195.49	2244.16	2242.75
γ 9.0	2121.02	2103.38	2046.80	2039.11	2032.48	2027.45	1999.36	1973.06	2066.98	2056.44	2109.42	2109.81
γ 10.0	1989.85	1959.56	1902.26	1895.69	1888.59	1882.33	1853.52	1827.43	1919.04	1910.91	1965.78	1968.58
γ 11.0	1850.94	1809.80	1754.56	1748.43	1740.47	1731.42	1703.56	1678.53	1765.81	1762.39	1818.58	1824.07
γ 12.0	1697.01	1656.85	1605.11	1600.02	1590.59	1578.28	1550.92	1528.57	1612.26	1613.46	1666.82	1674.54
γ 13.0	1544.30	1505.32	1455.77	1452.09	1441.43	1426.20	1399.46	1380.29	1458.99	1464.10	1515.22	1524.55
γ 14.0	1394.66	1356.67	1311.83	1309.31	1296.18	1279.83	1253.30	1237.10	1308.74	1317.54	1366.82	1377.53
γ 15.0	1249.47	1213.11	1175.51	1173.57	1157.89	1138.38	1113.76	1100.87	1164.31	1177.93	1223.55	1234.76
γ 16.0	1112.30	1076.63	1045.66	1044.18	1026.74	1003.82	979.42	971.32	1028.99	1045.75	1088.35	1099.62
γ 17.0	984.27	949.24	925.62	925.09	904.29	877.40	853.50	850.33	902.97	924.03	961.86	974.32
γ 18.0	866.62	833.88	818.28	818.94	795.34	763.42	741.54	741.69	790.39	814.52	849.09	861.49
γ 19.0	761.22	730.79	724.22	724.49	700.14	665.51	642.08	647.53	692.43	717.29	747.12	759.73
γ 20.0	667.64	637.86	638.80	639.42	615.13	577.23	554.12	564.43	605.60	630.81	654.90	669.93
γ 21.0	584.70	554.30	560.72	562.78	539.10	500.26	478.05	492.00	529.83	553.19	573.27	589.49
γ 22.0	511.73	479.81	489.61	493.42	470.34	432.36	412.84	427.60	462.50	484.20	498.77	517.22
γ 23.0	446.20	412.94	423.91	429.24	408.18	372.53	355.14	369.93	402.53	420.86	431.32	450.72
γ 24.0	386.48	353.72	365.45	371.22	352.55	320.19	305.50	317.96	346.17	362.63	370.07	390.35
γ 25.0	334.25	302.28	314.23	320.02	303.62	275.23	263.01	273.28	297.32	310.73	315.41	335.54
γ 26.0	288.11	258.06	269.56	274.95	260.63	236.41	226.14	234.54	254.16	265.51	267.81	286.74
γ 27.0	246.78	219.85	230.57	235.15	222.48	202.46	194.01	200.57	216.31	226.05	227.15	244.00
γ 28.0	210.32	186.51	195.53	199.89	188.49	172.12	165.60	170.69	183.34	191.72	192.31	206.60
γ 29.0	177.55	157.24	163.76	168.43	158.13	145.24	140.16	144.42	154.24	161.78	162.19	173.95
γ 30.0	148.91	131.44	136.68	140.51	131.31	121.19	117.48	121.59	128.98	135.64	136.48	145.22
γ 31.0	123.53	109.07	112.87	115.95	108.27	100.61	97.75	101.93	107.07	112.97	114.01	120.12
γ 32.0	102.02	90.15	93.10	94.95	89.21	83.26	81.35	85.39	88.62	93.51	94.43	98.49
γ 33.0	83.93	74.58	76.33	77.70	73.52	68.82	67.72	71.08	72.84	77.12	78.04	80.27
γ 34.0	69.11	61.97	62.87	63.75	60.63	57.17	56.12	59.10	60.14	63.50	64.33	65.35
γ 35.0	56.80	51.63	51.70	52.48	50.11	47.23	46.71	49.30	49.43	52.09	52.93	52.88
γ 36.0	46.93	42.94	42.46	42.99	41.18	38.98	38.95	40.99	40.06	42.41	43.03	42.40
γ 37.0	38.68	35.73	34.62	35.07	33.47	32.34	32.26	34.05	32.35	34.09	34.73	33.66
γ 38.0	31.92	30.03	28.41	28.73	27.50	26.92	26.72	27.96	25.35	26.90	27.55	26.36
γ 39.0	26.89	25.64	24.19	24.17	23.23	22.89	22.83	23.40	20.35	21.39	21.85	20.84
γ 40.0	23.72	22.51	21.65	21.58	20.55	20.34	20.45	20.51	16.82	17.68	18.09	16.97
γ 41.0	21.78	20.64	20.11	19.92	18.99	19.02	18.80	18.66	14.43	15.33	15.27	14.85
γ 42.0	20.55	19.49	19.31	18.88	17.96	17.86	17.79	17.51	13.22	13.81	13.64	13.35
γ 43.0	19.32	18.54	18.40	18.19	17.21	17.01	16.96	16.62	11.83	12.54	12.60	12.33
γ 44.0	18.21	17.78	17.49	17.19	16.70	16.27	16.09	16.22	11.22	11.45	11.53	11.27
γ 45.0	17.59	17.14	16.57	16.68	15.96	15.77	15.74	15.74	10.52	10.56	10.43	10.25
γ 46.0	16.82	16.44	16.01	16.23	15.51	15.48	14.98	15.16	9.90	9.77	9.65	9.61

IES Indoor Report

Photometric Filename:AW12540 15W 1204C9 3090 ZHT35-24D 350.IES

Candela Tabulation - (Cont.)

V/H	C0.0	C22.5	C45.0	C67.5	C90.0	C112.5	C135.0	C157.5	C180.0	C202.5	C225.0	C247.5
γ 47.0	16.45	15.90	15.74	15.48	15.06	14.90	14.40	14.56	9.22	9.09	9.04	8.79
γ 48.0	15.75	15.49	15.11	14.80	14.61	14.30	14.02	14.05	8.39	8.54	8.40	8.28
γ 49.0	15.00	14.82	14.56	14.34	14.07	13.80	13.55	13.52	7.61	7.88	7.71	7.48
γ 50.0	14.35	13.97	13.61	13.76	13.60	13.09	12.95	12.99	7.24	7.07	6.92	6.92
γ 51.0	13.90	13.51	12.99	12.99	13.01	12.50	12.25	12.45	6.34	6.35	6.21	6.21
γ 52.0	13.19	12.90	12.35	12.32	12.20	11.91	11.53	11.96	5.61	5.52	5.42	5.22
γ 53.0	12.74	12.06	12.01	11.72	11.72	11.31	11.17	11.16	4.89	4.89	5.05	4.65
γ 54.0	12.38	11.76	11.78	11.36	11.19	11.07	10.85	10.68	4.33	4.47	4.21	4.29
γ 55.0	11.88	11.53	11.04	11.10	10.65	10.78	10.64	10.38	4.05	4.09	4.22	3.90
γ 56.0	11.69	11.15	11.08	10.68	10.49	10.37	10.41	10.15	3.87	3.95	3.79	3.63
γ 57.0	11.15	11.08	10.46	10.53	10.16	10.13	10.22	9.81	3.88	3.87	3.70	3.38
γ 58.0	10.69	10.81	10.18	10.42	10.08	9.46	10.00	9.68	3.44	3.63	3.32	3.30
γ 59.0	11.04	10.35	9.60	10.01	9.90	9.62	9.78	9.40	3.43	3.53	3.21	3.18
γ 60.0	10.47	10.05	9.81	9.66	9.58	9.59	9.44	9.12	3.17	3.54	3.28	3.09
γ 61.0	10.29	9.89	9.84	9.35	9.25	9.42	9.06	8.90	3.24	3.44	3.10	2.92
γ 62.0	10.25	9.62	9.49	9.19	8.98	9.13	8.74	8.74	3.07	3.26	2.90	2.76
γ 63.0	9.89	9.13	9.23	8.96	8.92	9.02	8.63	8.42	2.95	2.97	2.78	2.55
γ 64.0	9.72	8.92	8.86	8.76	8.58	8.48	8.34	8.24	2.68	2.76	2.50	2.44
γ 65.0	9.04	8.77	8.49	8.38	8.15	8.02	7.97	8.09	2.49	2.55	2.52	2.36
γ 66.0	8.67	8.38	8.26	7.98	7.80	8.02	7.69	7.69	2.41	2.32	2.23	2.28
γ 67.0	8.55	8.01	7.72	7.69	7.72	7.68	7.69	7.51	2.13	2.20	2.03	2.09
γ 68.0	8.36	7.89	7.38	7.58	7.64	7.22	7.39	7.30	1.97	2.12	1.96	1.90
γ 69.0	8.22	7.57	7.25	7.28	7.42	7.19	7.09	7.22	2.12	2.00	2.04	2.00
γ 70.0	8.05	7.39	7.21	7.14	7.08	7.00	6.83	6.89	2.12	2.13	1.81	2.05
γ 71.0	7.80	7.32	7.19	6.95	6.94	6.80	6.77	6.71	1.77	2.29	1.99	1.89
γ 72.0	7.47	7.11	6.92	6.78	6.82	6.72	6.62	6.48	2.17	2.29	1.89	1.85
γ 73.0	7.47	7.03	6.62	6.58	6.62	6.33	6.37	6.45	2.07	2.35	1.98	1.85
γ 74.0	7.19	6.83	6.58	6.45	6.41	6.27	6.25	6.29	2.30	2.30	2.16	1.91
γ 75.0	6.99	6.73	6.33	6.28	6.32	6.30	6.07	6.16	2.29	2.24	2.37	1.89
γ 76.0	6.99	6.65	6.12	6.18	6.34	6.20	5.96	6.07	2.14	2.31	1.85	1.94
γ 77.0	6.74	6.55	5.89	6.16	6.14	6.01	5.72	5.85	2.63	2.42	2.14	2.00
γ 78.0	6.49	6.34	5.93	5.97	6.02	5.95	5.60	5.47	2.63	2.43	2.17	1.92
γ 79.0	6.47	6.11	5.62	5.69	6.05	5.59	5.40	5.44	2.33	2.55	2.11	2.11
γ 80.0	6.26	6.12	5.68	5.51	6.05	5.55	5.42	5.20	2.50	2.66	2.14	2.04
γ 81.0	6.07	6.10	5.50	5.51	5.78	5.51	5.25	5.22	2.62	2.54	2.29	2.19
γ 82.0	6.20	5.89	5.33	5.30	5.49	5.24	5.00	5.25	2.47	2.63	2.63	2.20
γ 83.0	6.00	5.73	5.55	5.29	5.29	5.29	4.95	4.95	2.53	2.74	2.36	2.17
γ 84.0	6.10	5.64	5.30	5.42	5.22	5.23	4.91	4.74	2.72	2.86	2.53	2.16
γ 85.0	5.73	5.63	5.24	5.39	5.28	5.22	4.70	4.75	2.61	2.95	2.58	2.36
γ 86.0	5.64	5.57	5.14	5.25	5.27	5.30	4.70	4.85	2.72	2.76	2.47	2.49
γ 87.0	5.82	5.45	5.19	5.07	5.14	5.31	4.76	4.58	2.68	2.84	2.60	2.58
γ 88.0	5.53	5.35	4.72	5.04	5.06	4.76	4.55	4.45	2.60	2.94	2.63	2.83
γ 89.0	5.46	5.13	4.81	5.01	5.07	5.20	4.45	4.41	2.78	2.78	2.78	2.88
γ 90.0	5.33	5.04	5.02	4.93	5.00	4.82	4.34	4.34	2.81	2.66	2.74	2.62
γ 91.0	5.29	5.00	4.67	4.73	4.99	4.80	4.22	4.06	2.66	2.82	2.67	2.63
γ 92.0	5.05	4.94	4.74	4.61	4.81	4.30	4.10	4.06	2.85	3.01	2.98	2.67
γ 93.0	5.04	4.97	4.82	4.55	4.64	4.49	4.16	4.17	2.89	2.91	2.87	2.58

IES Indoor Report

Photometric Filename:AW12540 15W 1204C9 3090 ZHT35-24D 350.IES

Candela Tabulation - (Cont.)

V/H	C0. 0	C22. 5	C45. 0	C67. 5	C90. 0	C112. 5	C135. 0	C157. 5	C180. 0	C202. 5	C225. 0	C247. 5
γ 94. 0	5.16	4.84	4.58	4.51	4.69	4.47	3.97	3.91	2.86	3.08	2.74	2.56
γ 95. 0	5.05	4.62	4.39	4.41	4.82	4.51	4.07	4.09	3.02	3.26	2.73	2.76
γ 96. 0	5.13	4.51	4.60	4.45	4.72	4.38	4.07	4.09	3.06	3.13	2.70	2.78
γ 97. 0	4.79	4.41	4.34	4.37	4.28	4.25	3.86	4.09	3.00	3.23	2.70	2.73
γ 98. 0	4.63	4.39	4.38	4.48	4.32	3.92	3.86	4.04	3.36	3.37	2.71	2.83
γ 99. 0	4.69	4.34	4.16	4.37	4.43	4.33	3.97	4.06	3.01	3.42	3.18	3.00
γ 100. 0	4.71	4.18	4.15	4.18	4.34	4.25	4.03	3.89	3.29	3.57	3.00	2.94
γ 101. 0	4.50	4.12	4.16	4.30	4.08	4.17	4.03	3.87	3.22	3.57	2.86	2.87
γ 102. 0	4.37	4.11	4.17	4.24	4.09	4.07	3.98	3.72	3.24	3.46	3.03	2.83
γ 103. 0	4.35	3.94	4.17	4.32	4.19	4.24	3.93	3.46	3.12	3.25	2.92	2.89
γ 104. 0	4.41	4.00	4.33	4.21	4.02	3.98	3.99	3.56	3.35	3.12	3.18	3.00
γ 105. 0	4.32	4.18	4.34	4.05	3.94	3.91	3.95	3.55	3.34	3.16	3.22	2.88
γ 106. 0	4.47	4.19	3.98	3.99	3.94	3.98	3.72	3.60	3.24	3.18	3.08	2.99
γ 107. 0	4.23	4.17	4.16	3.82	3.96	4.41	3.68	3.37	3.29	3.30	3.22	2.96
γ 108. 0	4.22	3.93	3.81	3.91	3.96	4.40	3.42	3.10	3.42	3.26	3.28	3.06
γ 109. 0	4.20	4.01	4.03	3.90	4.02	3.99	3.42	3.02	3.51	3.28	3.22	3.05
γ 110. 0	3.85	4.18	3.98	3.88	3.85	4.17	3.57	3.10	3.50	3.54	3.11	2.82
γ 111. 0	4.08	3.90	4.11	3.90	3.68	3.66	3.45	3.13	3.47	3.46	3.35	3.08
γ 112. 0	4.16	3.71	4.29	3.90	3.68	3.68	3.24	3.07	3.53	3.24	3.23	3.14
γ 113. 0	4.30	3.71	4.09	3.83	3.68	3.70	3.36	3.04	3.32	3.26	3.32	2.91
γ 114. 0	3.94	3.69	3.80	3.81	3.67	3.82	3.31	3.12	3.45	3.43	3.08	2.98
γ 115. 0	4.19	3.81	3.92	3.64	3.59	3.68	3.44	3.11	3.64	3.37	3.06	3.01
γ 116. 0	3.79	3.87	3.88	3.83	3.71	3.51	3.47	3.17	3.69	3.32	3.29	3.29
γ 117. 0	4.09	3.69	3.86	3.90	3.63	3.60	3.53	3.14	3.78	3.39	3.18	3.41
γ 118. 0	3.97	3.67	3.51	3.76	3.35	3.77	3.37	3.09	3.75	3.46	2.90	3.35
γ 119. 0	3.49	3.75	3.40	3.53	3.56	3.65	3.41	2.97	3.74	3.40	2.96	3.28
γ 120. 0	3.75	3.67	3.55	3.41	3.61	3.64	3.55	3.12	3.71	3.30	3.06	3.32
γ 121. 0	3.82	3.52	3.54	3.49	3.52	3.52	3.46	3.01	3.53	3.53	2.94	3.29
γ 122. 0	3.69	3.66	3.46	3.57	3.54	3.74	3.45	2.95	3.63	3.60	2.89	3.46
γ 123. 0	3.53	3.72	3.54	3.44	3.70	3.45	3.49	3.08	3.70	3.54	3.07	3.28
γ 124. 0	3.56	3.61	3.60	3.39	3.72	3.75	3.44	3.03	3.77	3.56	3.06	3.41
γ 125. 0	3.83	3.76	3.61	3.50	3.62	3.60	3.23	3.01	3.70	3.56	3.36	3.37
γ 126. 0	3.70	3.64	3.36	3.43	3.65	3.62	3.38	3.04	3.83	3.53	3.15	3.25
γ 127. 0	3.81	3.57	3.27	3.11	3.65	3.28	3.22	3.19	3.63	3.57	2.98	3.36
γ 128. 0	3.74	3.51	3.37	3.30	3.52	3.25	3.49	2.96	3.65	3.49	3.26	3.37
γ 129. 0	3.64	3.41	3.34	3.25	3.45	3.26	3.40	2.91	3.85	3.37	3.12	3.09
γ 130. 0	3.82	3.43	3.29	3.23	3.76	3.21	3.51	2.93	3.85	3.34	3.37	3.06
γ 131. 0	3.82	3.44	3.09	3.20	3.50	3.26	3.72	2.84	3.64	3.31	3.54	3.27
γ 132. 0	3.94	3.57	3.25	3.46	3.46	3.56	3.60	2.91	3.41	3.30	3.25	3.31
γ 133. 0	3.81	3.58	3.35	3.40	3.66	3.47	3.67	2.96	3.68	3.45	3.47	3.25
γ 134. 0	3.73	3.53	3.58	3.20	3.41	3.58	3.77	2.90	3.44	3.56	3.62	3.15
γ 135. 0	3.74	3.61	3.65	3.40	3.38	3.39	3.75	3.05	3.26	3.51	3.30	3.55
γ 136. 0	3.89	3.72	3.45	3.36	3.57	3.52	3.56	2.98	3.70	3.63	3.14	3.91
γ 137. 0	3.94	3.61	3.30	3.45	3.44	3.59	3.50	2.99	3.72	3.81	3.35	3.83
γ 138. 0	3.81	3.58	3.36	3.61	3.61	3.71	3.69	2.88	3.63	3.92	3.43	3.93
γ 139. 0	3.94	3.53	3.57	3.35	3.65	3.48	3.66	2.78	3.61	3.84	3.51	3.65
γ 140. 0	3.67	3.57	3.42	3.38	3.48	3.48	3.58	2.93	3.98	3.89	3.46	3.66

IES Indoor Report

Photometric Filename:AW12540 15W 1204C9 3090 ZHT35-24D 350.IES

Candela Tabulation - (Cont.)

V/H	C0. 0	C22. 5	C45. 0	C67. 5	C90. 0	C112. 5	C135. 0	C157. 5	C180. 0	C202. 5	C225. 0	C247. 5
γ 141. 0	3.93	3.75	3.57	3.42	3.58	3.73	3.47	3.08	3.82	3.96	3.66	3.93
γ 142. 0	3.99	3.91	3.48	3.64	3.57	3.89	3.54	3.01	4.05	4.01	3.45	3.98
γ 143. 0	4.01	4.01	3.69	3.64	3.65	3.81	3.86	3.24	4.01	4.02	3.74	3.98
γ 144. 0	3.91	3.94	3.77	3.63	3.58	4.20	4.02	3.30	3.98	3.94	3.74	3.99
γ 145. 0	4.03	3.84	3.83	3.80	3.77	4.04	4.06	3.68	4.08	4.05	3.68	4.09
γ 146. 0	4.33	3.97	3.83	3.90	4.00	4.18	4.23	3.72	4.19	4.10	3.80	4.17
γ 147. 0	4.66	4.18	4.01	3.85	4.15	4.03	4.49	3.80	4.08	4.07	3.91	3.97
γ 148. 0	4.44	4.15	4.20	4.01	4.19	4.58	4.61	3.83	4.21	4.08	3.98	4.06
γ 149. 0	4.55	4.19	4.20	4.24	4.33	4.64	5.02	3.74	4.25	4.09	3.89	4.22
γ 150. 0	4.65	4.38	4.37	4.30	4.49	4.87	5.13	4.02	4.54	4.27	3.81	4.33
γ 151. 0	4.70	4.56	4.80	4.28	4.59	5.23	5.59	4.22	4.24	4.36	4.18	4.37
γ 152. 0	4.64	4.69	4.69	4.62	4.63	5.32	6.04	4.40	4.67	4.21	4.20	4.44
γ 153. 0	4.81	4.73	4.74	4.70	4.62	6.03	6.85	4.29	4.60	4.26	4.38	4.36
γ 154. 0	4.86	4.91	4.65	4.72	4.71	6.61	7.72	4.34	4.64	4.46	4.55	4.47
γ 155. 0	5.07	5.16	4.87	4.69	4.77	6.86	8.12	4.24	4.94	4.58	4.82	4.75
γ 156. 0	5.31	5.14	5.01	4.76	4.93	6.67	7.68	4.48	4.87	4.81	4.98	4.63
γ 157. 0	5.13	5.23	5.32	4.84	5.11	5.80	6.82	4.51	5.04	5.09	5.05	4.76
γ 158. 0	5.30	5.34	5.17	4.99	5.33	5.06	5.95	4.60	5.27	5.28	5.02	4.81
γ 159. 0	5.37	5.30	5.11	5.25	5.46	5.05	5.69	4.73	5.51	5.41	4.80	4.81
γ 160. 0	5.30	5.38	5.52	5.26	5.52	5.10	5.89	4.83	5.23	5.43	5.20	5.14
γ 161. 0	5.55	5.41	5.51	5.06	5.46	5.51	6.17	5.02	5.28	5.54	5.01	4.98
γ 162. 0	5.40	5.58	5.32	5.06	5.42	5.22	6.64	5.24	5.62	5.49	5.07	5.21
γ 163. 0	5.55	5.80	5.45	5.29	5.32	5.40	7.03	5.76	5.65	5.59	5.30	5.28
γ 164. 0	5.92	5.74	5.64	5.29	5.55	5.77	7.43	6.13	5.54	5.74	5.63	5.22
γ 165. 0	5.84	5.74	5.84	5.34	5.53	5.65	7.10	5.95	5.51	5.73	5.33	5.39
γ 166. 0	5.64	5.92	5.93	5.46	5.50	5.41	5.90	5.52	5.70	5.84	5.68	5.48
γ 167. 0	5.85	5.91	6.00	5.41	5.42	5.52	5.19	5.24	5.63	5.98	5.56	5.53
γ 168. 0	5.83	5.89	6.06	5.64	5.53	5.53	5.29	5.29	5.73	6.05	5.44	5.62
γ 169. 0	5.51	5.91	5.96	5.65	5.53	5.48	5.21	5.52	6.01	6.11	5.69	5.70
γ 170. 0	5.76	5.92	5.95	5.61	5.49	5.20	5.33	5.45	5.90	6.16	5.73	5.67
γ 171. 0	6.01	6.16	5.90	5.83	5.46	5.54	5.36	5.41	5.74	6.10	5.68	5.33
γ 172. 0	5.91	6.04	6.17	5.91	5.56	5.44	5.34	5.30	5.88	6.15	5.74	5.36
γ 173. 0	5.82	5.69	5.97	5.81	5.53	5.38	5.39	5.47	5.89	6.19	5.76	5.47
γ 174. 0	5.99	5.75	5.79	5.77	5.49	5.38	5.54	5.37	5.95	6.12	5.54	5.53
γ 175. 0	5.97	5.90	5.73	5.79	5.46	5.66	5.67	5.47	5.83	6.14	5.52	5.68
γ 176. 0	5.85	5.80	5.66	5.82	5.49	5.37	5.37	5.60	5.97	6.13	5.60	5.86
γ 177. 0	5.88	5.89	6.02	5.67	5.63	5.28	5.42	5.38	5.93	6.08	5.83	5.74
γ 178. 0	5.90	5.85	6.11	5.84	5.58	5.40	5.37	5.26	6.02	6.07	5.94	5.55
γ 179. 0	5.93	5.77	5.80	5.81	5.63	5.57	5.38	5.20	5.83	6.07	5.72	5.57
γ 180. 0	5.60	5.60	5.60	5.60	5.60	5.60	5.60	5.60	5.60	5.60	5.60	5.60
V/H	C270. 0	C292. 5	C315. 0	C337. 5								
γ 0. 0	2767.83	2767.83	2767.83	2767.83								
γ 1. 0	2762.06	2753.77	2720.63	2698.89								
γ 2. 0	2738.10	2729.91	2695.65	2673.85								
γ 3. 0	2695.47	2685.46	2650.70	2627.58								
γ 4. 0	2636.26	2625.97	2585.78	2563.01								
γ 5. 0	2557.16	2545.61	2505.33	2480.50								

IES Indoor Report

Photometric Filename:AW12540 15W 1204C9 3090 ZHT35-24D 350.IES

Candela Tabulation - (Cont.)

V/H	C270. 0	C292. 5	C315. 0	C337. 5
γ 6. 0	2461. 46	2447. 56	2406. 53	2380. 26
γ 7. 0	2353. 29	2338. 74	2294. 06	2268. 10
γ 8. 0	2231. 69	2215. 74	2170. 56	2143. 67
γ 9. 0	2099. 61	2084. 46	2036. 49	2009. 29
γ 10. 0	1962. 01	1946. 75	1897. 15	1870. 46
γ 11. 0	1818. 64	1802. 61	1755. 12	1727. 03
γ 12. 0	1671. 78	1657. 51	1609. 63	1580. 80
γ 13. 0	1525. 16	1511. 92	1464. 47	1435. 18
γ 14. 0	1380. 86	1366. 96	1322. 59	1292. 79
γ 15. 0	1240. 84	1228. 07	1185. 05	1154. 80
γ 16. 0	1107. 61	1095. 25	1053. 81	1024. 30
γ 17. 0	983. 40	970. 76	930. 91	902. 64
γ 18. 0	870. 09	856. 32	818. 03	790. 78
γ 19. 0	768. 72	753. 13	714. 47	688. 63
γ 20. 0	678. 41	662. 61	621. 72	597. 84
γ 21. 0	598. 45	582. 22	540. 42	517. 53
γ 22. 0	526. 73	511. 81	468. 52	448. 05
γ 23. 0	461. 55	448. 45	406. 43	386. 95
γ 24. 0	402. 02	390. 93	351. 89	333. 51
γ 25. 0	347. 59	338. 59	303. 73	285. 64
γ 26. 0	299. 05	293. 23	261. 58	243. 81
γ 27. 0	256. 02	252. 40	224. 76	207. 91
γ 28. 0	217. 53	215. 95	192. 26	176. 33
γ 29. 0	183. 66	183. 15	163. 03	148. 84
γ 30. 0	153. 41	153. 40	137. 27	125. 37
γ 31. 0	127. 05	127. 12	115. 09	104. 92
γ 32. 0	104. 18	104. 41	95. 57	87. 33
γ 33. 0	84. 89	84. 83	78. 39	71. 89
γ 34. 0	68. 98	68. 79	64. 11	59. 13
γ 35. 0	55. 82	55. 10	52. 15	48. 33
γ 36. 0	44. 78	44. 48	42. 15	38. 98
γ 37. 0	35. 49	35. 03	33. 50	31. 20
γ 38. 0	27. 62	27. 00	26. 26	24. 69
γ 39. 0	21. 43	21. 08	20. 62	19. 55
γ 40. 0	17. 19	16. 83	16. 68	15. 96
γ 41. 0	14. 63	14. 33	14. 29	13. 62
γ 42. 0	13. 36	13. 21	12. 92	12. 10
γ 43. 0	12. 32	12. 14	11. 70	11. 16
γ 44. 0	11. 24	10. 99	10. 85	10. 32
γ 45. 0	10. 48	10. 19	9. 98	9. 60
γ 46. 0	9. 80	9. 61	9. 35	9. 01
γ 47. 0	9. 18	9. 01	8. 63	8. 35
γ 48. 0	8. 35	8. 19	8. 04	7. 53
γ 49. 0	7. 42	7. 51	7. 21	7. 01
γ 50. 0	6. 87	6. 60	6. 41	6. 45
γ 51. 0	6. 44	6. 22	5. 75	5. 64
γ 52. 0	5. 66	5. 32	5. 22	4. 78

IES Indoor Report

Photometric Filename:AW12540 15W 1204C9 3090 ZHT35-24D 350.IES

Candela Tabulation - (Cont.)

V/H	C270. 0	C292. 5	C315. 0	C337. 5
γ 53. 0	4. 93	4. 77	4. 47	4. 11
γ 54. 0	4. 46	4. 46	3. 96	3. 74
γ 55. 0	4. 23	3. 97	3. 85	3. 26
γ 56. 0	3. 72	3. 64	3. 56	2. 84
γ 57. 0	3. 64	3. 77	3. 50	2. 75
γ 58. 0	3. 70	3. 39	3. 27	2. 57
γ 59. 0	3. 53	3. 01	3. 01	2. 56
γ 60. 0	3. 21	3. 26	2. 78	2. 49
γ 61. 0	2. 92	2. 93	2. 73	2. 32
γ 62. 0	2. 69	3. 01	2. 61	2. 33
γ 63. 0	2. 33	2. 67	2. 34	2. 29
γ 64. 0	2. 38	2. 58	2. 36	2. 08
γ 65. 0	2. 26	2. 13	2. 37	1. 70
γ 66. 0	1. 98	2. 10	1. 87	1. 42
γ 67. 0	2. 00	1. 84	1. 81	1. 54
γ 68. 0	2. 05	1. 92	1. 83	1. 50
γ 69. 0	1. 95	2. 13	1. 80	1. 44
γ 70. 0	1. 71	2. 20	1. 74	1. 75
γ 71. 0	1. 79	2. 05	2. 01	1. 66
γ 72. 0	1. 87	2. 05	2. 05	1. 65
γ 73. 0	2. 01	2. 31	2. 08	1. 72
γ 74. 0	2. 14	1. 85	1. 94	1. 74
γ 75. 0	2. 09	2. 23	1. 92	1. 85
γ 76. 0	1. 97	2. 13	1. 77	1. 84
γ 77. 0	2. 14	2. 04	1. 95	1. 77
γ 78. 0	2. 25	1. 97	1. 91	1. 93
γ 79. 0	2. 29	1. 91	1. 87	1. 96
γ 80. 0	2. 22	2. 17	2. 10	1. 97
γ 81. 0	2. 34	2. 23	2. 36	2. 10
γ 82. 0	2. 47	2. 16	2. 31	2. 18
γ 83. 0	2. 55	2. 58	2. 34	2. 06
γ 84. 0	2. 50	2. 64	2. 46	2. 30
γ 85. 0	2. 46	2. 55	2. 41	2. 49
γ 86. 0	2. 50	2. 26	2. 45	2. 30
γ 87. 0	2. 43	2. 64	2. 43	2. 42
γ 88. 0	2. 52	2. 62	2. 58	2. 59
γ 89. 0	2. 60	2. 48	2. 62	2. 58
γ 90. 0	2. 65	2. 67	2. 73	2. 75
γ 91. 0	2. 87	2. 59	2. 93	2. 88
γ 92. 0	3. 12	2. 81	2. 88	2. 69
γ 93. 0	3. 24	2. 74	2. 64	2. 45
γ 94. 0	3. 15	3. 10	2. 78	2. 43
γ 95. 0	3. 35	2. 67	2. 70	2. 54
γ 96. 0	3. 44	2. 92	3. 04	2. 62
γ 97. 0	3. 11	2. 89	2. 97	2. 78
γ 98. 0	2. 88	2. 99	2. 89	2. 74
γ 99. 0	3. 01	3. 05	2. 97	2. 64

IES Indoor Report

Photometric Filename:AW12540 15W 1204C9 3090 ZHT35-24D 350.IES

Candela Tabulation - (Cont.)

V/H	C270.0	C292.5	C315.0	C337.5
γ 100.0	3.17	2.97	3.11	2.57
γ 101.0	3.07	2.78	3.11	2.58
γ 102.0	3.08	3.02	2.92	2.73
γ 103.0	3.08	2.72	3.11	2.91
γ 104.0	3.09	3.12	3.26	3.10
γ 105.0	3.20	3.24	3.09	2.93
γ 106.0	3.39	3.33	3.11	2.88
γ 107.0	3.39	3.03	3.07	2.77
γ 108.0	3.15	2.92	3.05	2.91
γ 109.0	3.06	3.39	2.97	2.72
γ 110.0	3.29	3.09	2.79	2.63
γ 111.0	3.44	3.21	2.87	2.79
γ 112.0	3.45	3.07	3.03	2.83
γ 113.0	3.49	3.17	3.34	2.79
γ 114.0	3.37	3.19	3.17	2.96
γ 115.0	3.43	3.11	2.87	3.07
γ 116.0	3.41	3.24	2.99	3.08
γ 117.0	3.38	3.19	3.00	2.89
γ 118.0	3.57	3.22	2.96	2.74
γ 119.0	3.50	3.23	3.15	2.68
γ 120.0	3.49	3.01	3.13	2.76
γ 121.0	3.60	3.31	3.08	2.63
γ 122.0	3.63	3.43	3.07	2.52
γ 123.0	3.37	3.16	3.08	2.54
γ 124.0	3.25	3.40	2.99	2.73
γ 125.0	3.12	3.22	3.03	2.73
γ 126.0	3.10	3.11	2.91	2.67
γ 127.0	3.08	3.21	2.90	2.77
γ 128.0	3.24	3.07	3.00	2.97
γ 129.0	3.24	3.12	3.17	2.90
γ 130.0	3.29	3.19	3.18	2.72
γ 131.0	3.25	2.85	3.42	2.75
γ 132.0	3.39	3.22	3.28	2.73
γ 133.0	3.30	3.01	3.30	2.76
γ 134.0	3.30	3.16	3.32	2.60
γ 135.0	3.42	3.19	3.28	2.77
γ 136.0	3.45	2.98	3.12	2.88
γ 137.0	3.36	3.23	3.23	2.87
γ 138.0	3.39	3.23	3.26	2.74
γ 139.0	3.44	3.03	3.35	2.88
γ 140.0	3.60	3.68	3.49	3.05
γ 141.0	3.54	3.46	3.41	3.06
γ 142.0	3.57	3.46	3.42	3.12
γ 143.0	3.74	3.63	3.32	3.14
γ 144.0	3.58	3.61	3.61	3.26
γ 145.0	3.45	3.77	3.53	3.24
γ 146.0	3.53	3.57	3.47	3.28

IES Indoor Report

Photometric Filename:AW12540 15W 1204C9 3090 ZHT35-24D 350.IES

Candela Tabulation - (Cont.)

V/H	C270.0	C292.5	C315.0	C337.5
γ 147.0	3.65	3.80	3.68	3.59
γ 148.0	3.79	3.81	3.80	3.69
γ 149.0	3.92	4.21	3.67	3.76
γ 150.0	4.13	3.88	3.76	3.81
γ 151.0	4.18	3.90	3.69	3.99
γ 152.0	4.28	4.14	3.86	4.07
γ 153.0	4.35	4.03	4.02	4.03
γ 154.0	4.29	4.25	4.30	4.03
γ 155.0	4.39	4.63	4.31	4.33
γ 156.0	4.61	4.66	4.42	4.37
γ 157.0	4.72	4.87	4.36	4.35
γ 158.0	4.72	4.75	4.52	4.62
γ 159.0	4.53	4.89	4.56	4.63
γ 160.0	4.64	5.13	4.76	4.54
γ 161.0	4.89	5.03	4.88	4.60
γ 162.0	4.87	4.88	5.07	4.68
γ 163.0	4.95	5.14	5.10	4.80
γ 164.0	5.22	5.20	5.01	4.83
γ 165.0	5.36	5.39	4.92	4.96
γ 166.0	5.34	5.40	5.20	4.74
γ 167.0	5.34	5.23	5.37	4.89
γ 168.0	5.17	5.24	5.41	4.98
γ 169.0	5.28	5.20	5.28	5.19
γ 170.0	5.36	5.28	5.25	5.26
γ 171.0	5.31	5.40	5.34	5.28
γ 172.0	5.44	5.43	5.39	5.14
γ 173.0	5.59	5.57	5.39	5.18
γ 174.0	5.53	5.43	5.48	5.05
γ 175.0	5.52	5.42	5.42	5.20
γ 176.0	5.40	5.46	5.40	5.13
γ 177.0	5.41	5.27	5.37	5.23
γ 178.0	5.57	5.48	5.42	5.26
γ 179.0	5.68	5.55	5.37	5.31
γ 180.0	5.60	5.60	5.60	5.60
