

# IES Indoor Report

Photometric Filename:AW12540 8W 1202C9 3090 ZHT35-36D 200.IES

## Indoor Luminaire Photometric Data

### Description Information

Luminaire Name: AW12540	Lum. Catalog: Down Light	Test ID:
Lamp Name: 1202C9	Lamp Catalog: COB	Test Date: 2023/06/29
Manufacture: -	Shld. Ang(°): 36	Test Machine:GON-2000
Test Lab: Test	Frequency(Hz): 50	Lamp CCT(K): 3000 Ra: 90
Lum. Size (W*L*H): 0.066m*0.066m*0.000m	Lum. Area (m2): 0.003	Lum. W (kg): 0.000
Test System: C, $\gamma$	Test Step: C=22.5 $\gamma$ =1.0	Temp. (°C): 25
		Humidity (%): 50.0

### Character Parameter

Lamp Speciality Parameter		Luminaire Speciality Parameter	
Rated Flux(lm): 608.000	Luminaire Flux(lm): 608.811	Field Angle(10%Imax): 65.5(°)	
Rated Power(W): 8	Luminaire Efficiency: 100.13%	Down Lumens&Percent: 589.556lm 96.84%	
Rated Voltage(V): 220	Luminaire EER(lm/W): 73.166	Up Lumens&Percent: 19.255lm 3.16%	
Tested Power(W): 8.321	Max. Candela(cd): 1072.375	S/MH: C0_a180=0.728 C90_270=0.732	
Lamps' Inside: 1	Max Cand@Ang.(°): C=225.0 $\gamma$ =1.0	CIE Type: Semi-Direct	
Tested Electrics(V, A, pf): 220.5, 0.065, 0.576	Beam Angle(50%Imax): 44.4(°)	ErP $\Phi$ use(90°): 568.377lm	
Lamp Size(W*L*H): 0.066m*0.066m*0.000m	Left=-21.9°, Right=22.6°	IRF(%): 390.102	

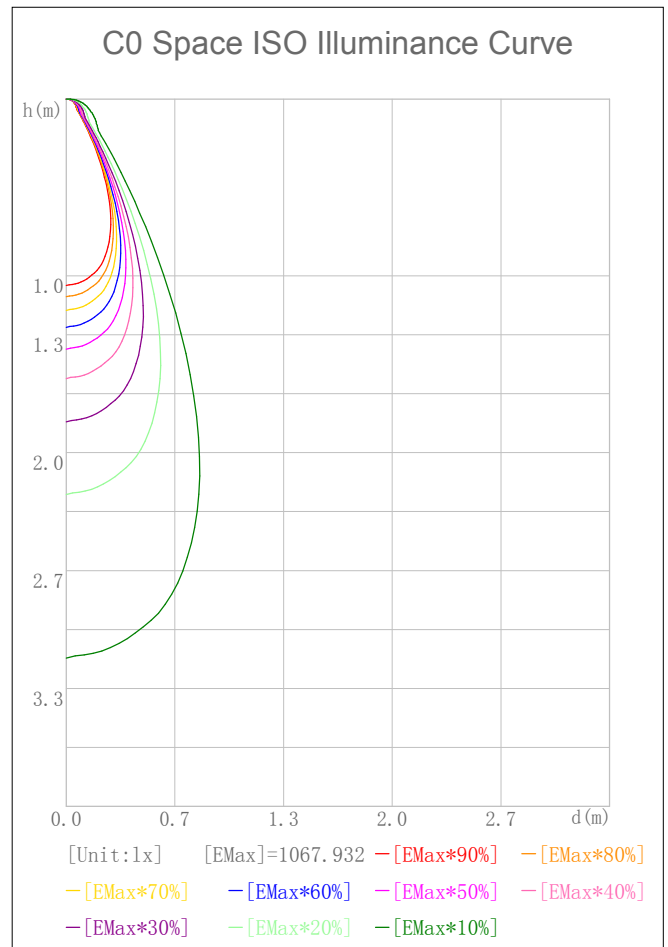
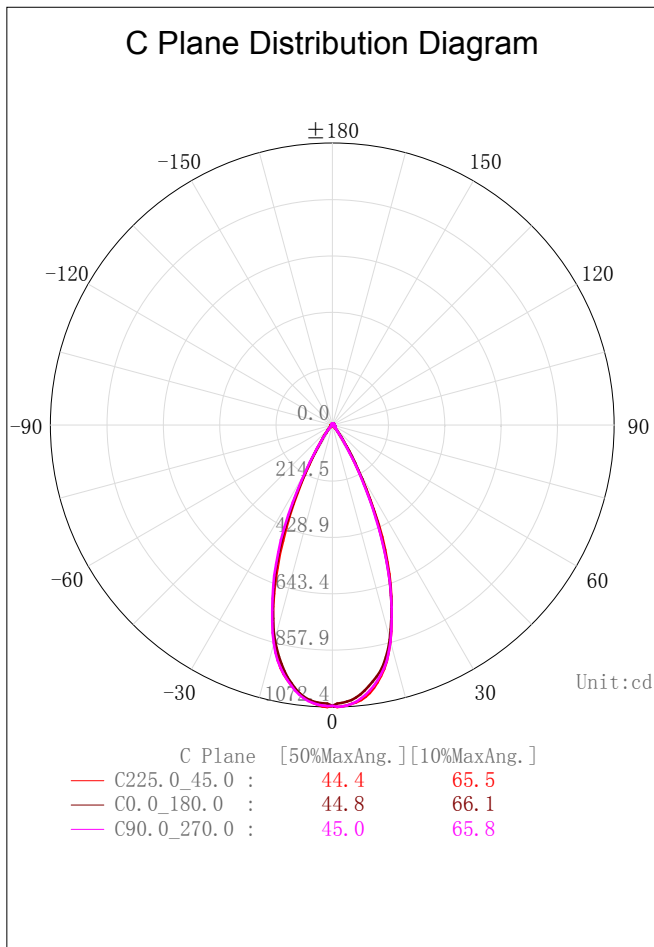

# IES Indoor Report

Photometric Filename:AW12540 8W 1202C9 3090 ZHT35-36D 200.IES

## 2D Plane Light Intensity Distribution Curve

Lum. Name: AW12540	Lum. Catalog: Down Light	Test ID:
Lamp Name: 1202C9	Lamp Catalog: COB	Test Lab: Test
Manufacture: -	Test Machine: GON-2000	Test Date: 2023/06/29

C Plane Distribution Diagram

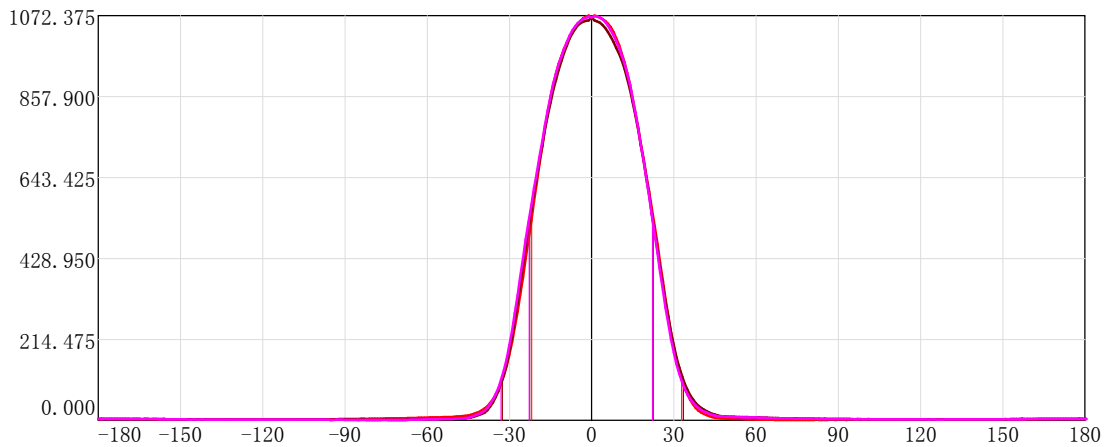
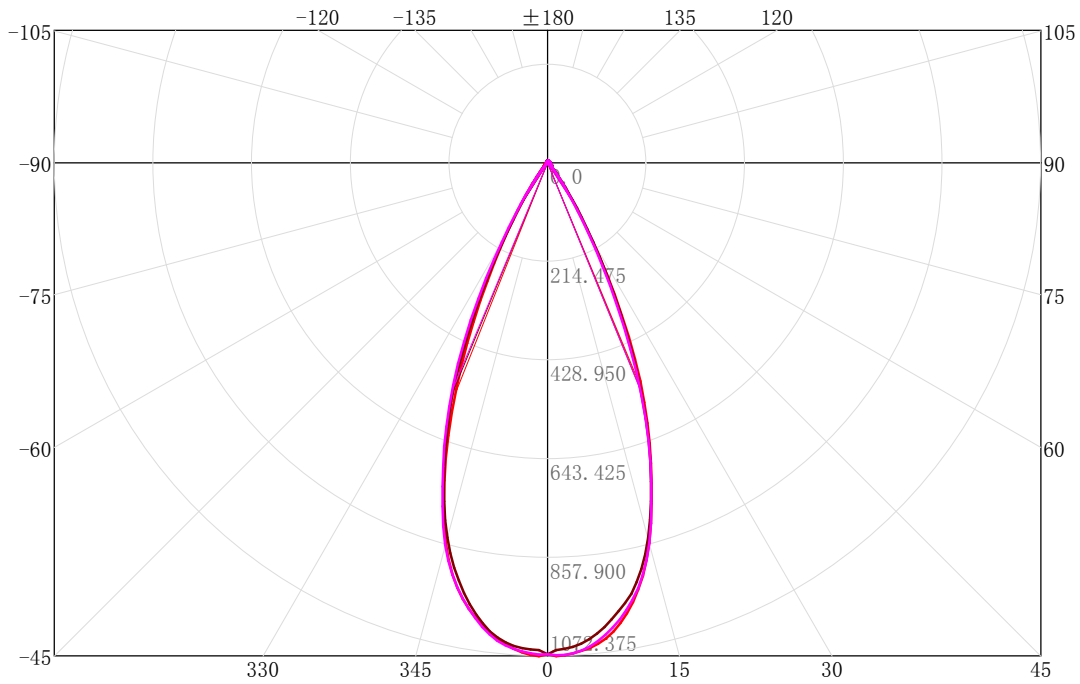

	C Plane	[50%MaxAng.]	[10%MaxAng.]	Unit:cd
—	C225.0_45.0 :	44.4	65.5	
—	C0.0_180.0 :	44.8	66.1	
—	C90.0_270.0 :	45.0	65.8	

**IES Indoor Report**

**Photometric Filename:AW12540 8W 1202C9 3090 ZHT35-36D 200.IES**

---

**3D Light Intensity Distribution Modal**

Lum. Name: AW12540	Lum. Catalog: Down Light	Test ID:
Lamp Name: 1202C9	Lamp Catalog: COB	Test Lab: Test
Manufacture: -	Test Machine: GON-2000	Test Date: 2023/06/29

**3D Light Intensity Distribution Modal**

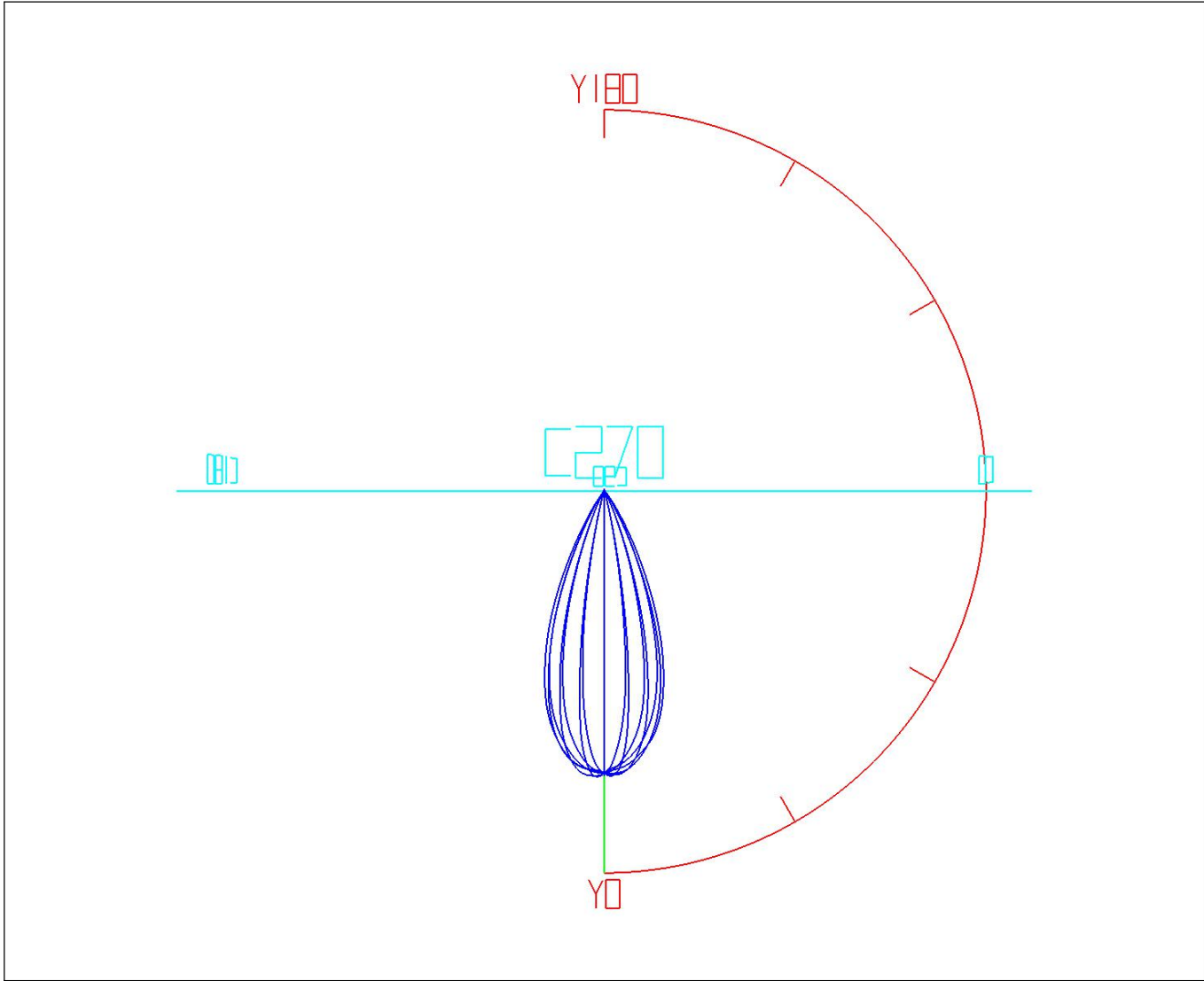

Curves: 3D Model ——— Fixture ——— Vert. HUD ——— Hori. HUD ———  
View Angles: Orient:0 Tilt:0 Roll:0 Spin:0

---

# IES Indoor Report

Photometric Filename:AW12540 8W 1202C9 3090 ZHT35-36D 200.IES

## Zonal Flux Tabulation

Zone (γ)	Zone Flux (lm)	Sums Flux (lm)	Zone%Lamp	Sums%Lamp	Zone (γ)	Zone Flux (lm)	Sums Flux (lm)	Zone%Lamp	Sums%Lamp
0.0-1.0	1.02	1.02	0.17	0.17	47.0-48.0	0.68	570.50	0.11	93.83
1.0-2.0	3.06	4.08	0.50	0.67	48.0-49.0	0.66	571.16	0.11	93.94
2.0-3.0	5.09	9.18	0.84	1.51	49.0-50.0	0.64	571.81	0.11	94.05
3.0-4.0	7.10	16.28	1.17	2.68	50.0-51.0	0.62	572.43	0.10	94.15
4.0-5.0	9.07	25.35	1.49	4.17	51.0-52.0	0.61	573.04	0.10	94.25
5.0-6.0	11.00	36.35	1.81	5.98	52.0-53.0	0.59	573.63	0.10	94.35
6.0-7.0	12.86	49.21	2.12	8.09	53.0-54.0	0.58	574.21	0.10	94.44
7.0-8.0	14.65	63.86	2.41	10.50	54.0-55.0	0.57	574.79	0.09	94.54
8.0-9.0	16.34	80.19	2.69	13.19	55.0-56.0	0.56	575.35	0.09	94.63
9.0-10.0	17.93	98.12	2.95	16.14	56.0-57.0	0.56	575.91	0.09	94.72
10.0-11.0	19.41	117.53	3.19	19.33	57.0-58.0	0.55	576.45	0.09	94.81
11.0-12.0	20.76	138.30	3.41	22.75	58.0-59.0	0.54	576.99	0.09	94.90
12.0-13.0	21.97	160.26	3.61	26.36	59.0-60.0	0.53	577.52	0.09	94.99
13.0-14.0	22.99	183.25	3.78	30.14	60.0-61.0	0.52	578.04	0.09	95.07
14.0-15.0	23.81	207.06	3.92	34.06	61.0-62.0	0.51	578.55	0.08	95.16
15.0-16.0	24.38	231.44	4.01	38.07	62.0-63.0	0.50	579.05	0.08	95.24
16.0-17.0	24.71	256.16	4.06	42.13	63.0-64.0	0.48	579.53	0.08	95.32
17.0-18.0	24.82	280.97	4.08	46.21	64.0-65.0	0.47	579.99	0.08	95.39
18.0-19.0	24.73	305.70	4.07	50.28	65.0-66.0	0.45	580.44	0.07	95.47
19.0-20.0	24.45	330.15	4.02	54.30	66.0-67.0	0.43	580.88	0.07	95.54
20.0-21.0	23.94	354.09	3.94	58.24	67.0-68.0	0.42	581.30	0.07	95.61
21.0-22.0	23.20	377.29	3.82	62.05	68.0-69.0	0.42	581.72	0.07	95.68
22.0-23.0	22.22	399.51	3.65	65.71	69.0-70.0	0.41	582.13	0.07	95.75
23.0-24.0	21.02	420.53	3.46	69.17	70.0-71.0	0.41	582.54	0.07	95.81
24.0-25.0	19.61	440.14	3.22	72.39	71.0-72.0	0.40	582.94	0.07	95.88
25.0-26.0	18.03	458.16	2.96	75.36	72.0-73.0	0.40	583.33	0.07	95.94
26.0-27.0	16.33	474.49	2.69	78.04	73.0-74.0	0.39	583.73	0.06	96.01
27.0-28.0	14.58	489.07	2.40	80.44	74.0-75.0	0.39	584.12	0.06	96.07
28.0-29.0	12.83	501.90	2.11	82.55	75.0-76.0	0.39	584.50	0.06	96.13
29.0-30.0	11.13	513.02	1.83	84.38	76.0-77.0	0.38	584.88	0.06	96.20
30.0-31.0	9.53	522.55	1.57	85.95	77.0-78.0	0.38	585.26	0.06	96.26
31.0-32.0	8.08	530.63	1.33	87.28	78.0-79.0	0.37	585.64	0.06	96.32
32.0-33.0	6.81	537.44	1.12	88.39	79.0-80.0	0.37	586.01	0.06	96.38
33.0-34.0	5.71	543.15	0.94	89.33	80.0-81.0	0.37	586.37	0.06	96.44
34.0-35.0	4.78	547.94	0.79	90.12	81.0-82.0	0.36	586.74	0.06	96.50
35.0-36.0	3.99	551.93	0.66	90.78	82.0-83.0	0.36	587.10	0.06	96.56
36.0-37.0	3.31	555.24	0.54	91.32	83.0-84.0	0.36	587.45	0.06	96.62
37.0-38.0	2.73	557.97	0.45	91.77	84.0-85.0	0.35	587.81	0.06	96.68
38.0-39.0	2.25	560.22	0.37	92.14	85.0-86.0	0.35	588.16	0.06	96.74
39.0-40.0	1.89	562.11	0.31	92.45	86.0-87.0	0.35	588.51	0.06	96.79
40.0-41.0	1.61	563.72	0.27	92.72	87.0-88.0	0.35	588.86	0.06	96.85
41.0-42.0	1.40	565.12	0.23	92.95	88.0-89.0	0.35	589.21	0.06	96.91
42.0-43.0	1.22	566.34	0.20	93.15	89.0-90.0	0.35	589.56	0.06	96.97
43.0-44.0	1.05	567.39	0.17	93.32	90.0-91.0	0.35	589.91	0.06	97.02
44.0-45.0	0.91	568.29	0.15	93.47	91.0-92.0	0.35	590.26	0.06	97.08
45.0-46.0	0.80	569.09	0.13	93.60	92.0-93.0	0.34	590.60	0.06	97.14
46.0-47.0	0.73	569.82	0.12	93.72	93.0-94.0	0.34	590.94	0.06	97.19

# IES Indoor Report

Photometric Filename:AW12540 8W 1202C9 3090 ZHT35-36D 200.IES

## Zonal Flux Tabulation - (Cont.)

Zone (γ)	Zone Flux (lm)	Sums Flux (lm)	Zone%Lamp	Sums%Lamp	Zone (γ)	Zone Flux (lm)	Sums Flux (lm)	Zone%Lamp	Sums%Lamp
94.0-95.0	0.33	591.27	0.05	97.25	141.0-142.0	0.21	603.96	0.03	99.34
95.0-96.0	0.33	591.60	0.05	97.30	142.0-143.0	0.21	604.17	0.03	99.37
96.0-97.0	0.33	591.93	0.05	97.36	143.0-144.0	0.21	604.37	0.03	99.40
97.0-98.0	0.33	592.27	0.05	97.41	144.0-145.0	0.20	604.58	0.03	99.44
98.0-99.0	0.33	592.60	0.05	97.47	145.0-146.0	0.20	604.78	0.03	99.47
99.0-100.0	0.33	592.93	0.05	97.52	146.0-147.0	0.20	604.97	0.03	99.50
100.0-101.0	0.33	593.25	0.05	97.57	147.0-148.0	0.20	605.17	0.03	99.53
101.0-102.0	0.32	593.58	0.05	97.63	148.0-149.0	0.19	605.36	0.03	99.57
102.0-103.0	0.32	593.90	0.05	97.68	149.0-150.0	0.19	605.55	0.03	99.60
103.0-104.0	0.32	594.21	0.05	97.73	150.0-151.0	0.19	605.74	0.03	99.63
104.0-105.0	0.31	594.53	0.05	97.78	151.0-152.0	0.18	605.93	0.03	99.66
105.0-106.0	0.31	594.83	0.05	97.83	152.0-153.0	0.18	606.11	0.03	99.69
106.0-107.0	0.30	595.13	0.05	97.88	153.0-154.0	0.18	606.28	0.03	99.72
107.0-108.0	0.30	595.43	0.05	97.93	154.0-155.0	0.17	606.46	0.03	99.75
108.0-109.0	0.30	595.73	0.05	97.98	155.0-156.0	0.17	606.63	0.03	99.77
109.0-110.0	0.29	596.02	0.05	98.03	156.0-157.0	0.17	606.79	0.03	99.80
110.0-111.0	0.29	596.31	0.05	98.08	157.0-158.0	0.16	606.96	0.03	99.83
111.0-112.0	0.29	596.60	0.05	98.13	158.0-159.0	0.15	607.11	0.03	99.85
112.0-113.0	0.29	596.89	0.05	98.17	159.0-160.0	0.15	607.26	0.02	99.88
113.0-114.0	0.29	597.18	0.05	98.22	160.0-161.0	0.14	607.40	0.02	99.90
114.0-115.0	0.28	597.46	0.05	98.27	161.0-162.0	0.14	607.54	0.02	99.92
115.0-116.0	0.28	597.74	0.05	98.31	162.0-163.0	0.13	607.67	0.02	99.95
116.0-117.0	0.28	598.02	0.05	98.36	163.0-164.0	0.12	607.79	0.02	99.97
117.0-118.0	0.27	598.29	0.04	98.40	164.0-165.0	0.12	607.91	0.02	99.99
118.0-119.0	0.27	598.56	0.04	98.45	165.0-166.0	0.11	608.02	0.02	100.00
119.0-120.0	0.26	598.82	0.04	98.49	166.0-167.0	0.11	608.13	0.02	100.02
120.0-121.0	0.26	599.08	0.04	98.53	167.0-168.0	0.10	608.22	0.02	100.04
121.0-122.0	0.26	599.34	0.04	98.58	168.0-169.0	0.09	608.32	0.02	100.05
122.0-123.0	0.25	599.59	0.04	98.62	169.0-170.0	0.08	608.40	0.01	100.07
123.0-124.0	0.25	599.84	0.04	98.66	170.0-171.0	0.08	608.48	0.01	100.08
124.0-125.0	0.25	600.08	0.04	98.70	171.0-172.0	0.07	608.55	0.01	100.09
125.0-126.0	0.25	600.33	0.04	98.74	172.0-173.0	0.06	608.61	0.01	100.10
126.0-127.0	0.24	600.57	0.04	98.78	173.0-174.0	0.05	608.66	0.01	100.11
127.0-128.0	0.24	600.81	0.04	98.82	174.0-175.0	0.05	608.71	0.01	100.12
128.0-129.0	0.24	601.05	0.04	98.86	175.0-176.0	0.04	608.74	0.01	100.12
129.0-130.0	0.23	601.28	0.04	98.89	176.0-177.0	0.03	608.77	0.00	100.13
130.0-131.0	0.23	601.51	0.04	98.93	177.0-178.0	0.02	608.79	0.00	100.13
131.0-132.0	0.23	601.75	0.04	98.97	178.0-179.0	0.01	608.81	0.00	100.13
132.0-133.0	0.23	601.98	0.04	99.01	179.0-180.0	0.00	608.81	0.00	100.13
133.0-134.0	0.23	602.20	0.04	99.05					
134.0-135.0	0.23	602.43	0.04	99.08					
135.0-136.0	0.22	602.65	0.04	99.12					
136.0-137.0	0.22	602.88	0.04	99.16					
137.0-138.0	0.22	603.10	0.04	99.19					
138.0-139.0	0.22	603.31	0.04	99.23					
139.0-140.0	0.22	603.53	0.04	99.26					
140.0-141.0	0.22	603.75	0.04	99.30					

# IES Indoor Report

Photometric Filename:AW12540 8W 1202C9 3090 ZHT35-36D 200.IES

## Rectangle ISO Lighting Intensity Diagram

Lum. Name: AW12540	Lum. Catalog: Down Light	Test ID:
Lamp Name: 1202C9	Lamp Catalog: COB	Test Lab: Test
Manufacture: -	Test Machine: GON-2000	Test Date: 2023/06/29

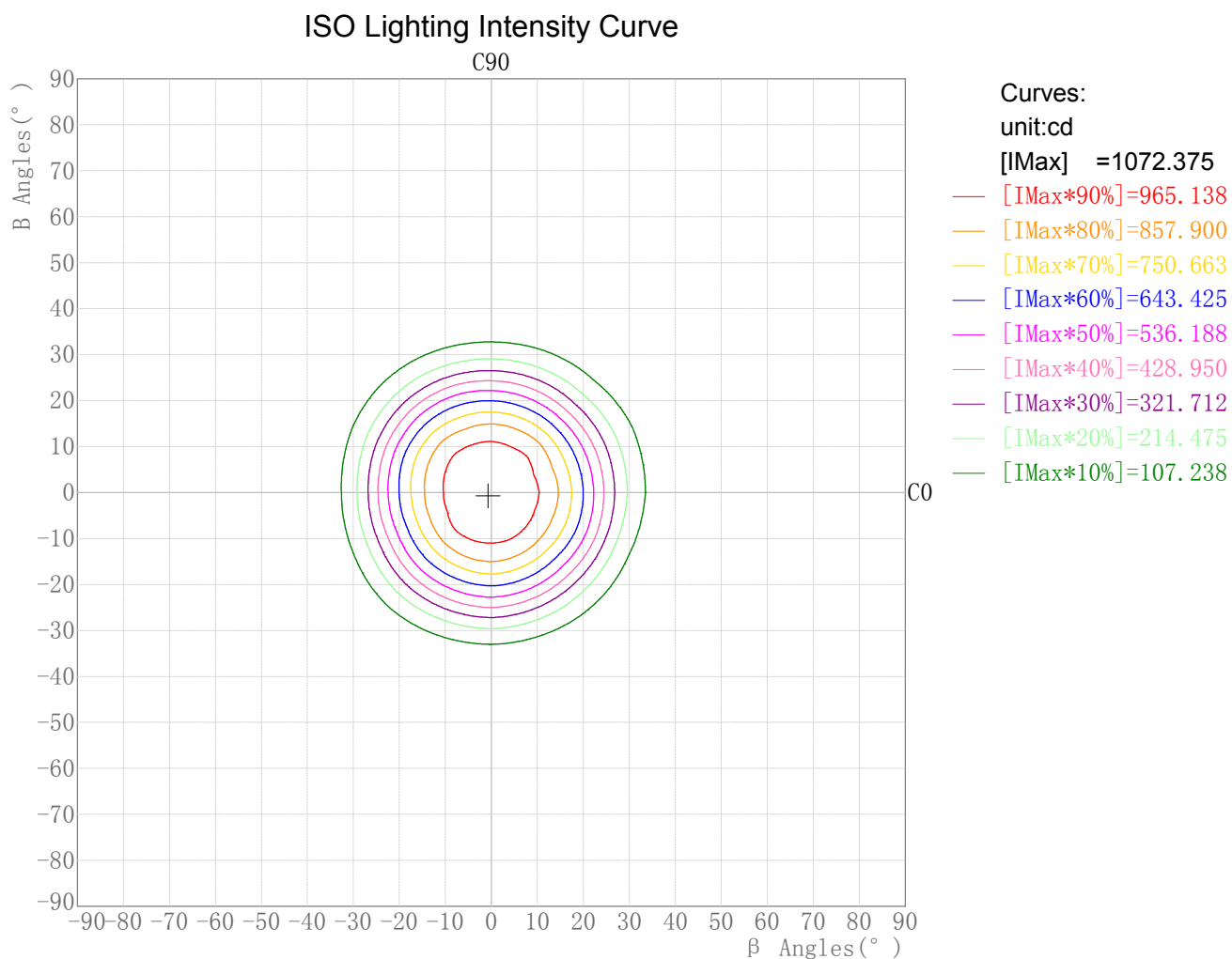

Maximum Light Intensity(cd): 1072.38  
Maximum Cand.@Angle: H=-0.7°,V=-0.7°

# IES Indoor Report

Photometric Filename:AW12540 8W 1202C9 3090 ZHT35-36D 200.IES

## Round ISO Lighting Intensity Diagram

Lum. Name: AW12540	Lum. Catalog: Down Light	Test ID:
Lamp Name: 1202C9	Lamp Catalog: COB	Test Lab: Test
Manufacture: -	Test Machine: GON-2000	Test Date: 2023/06/29

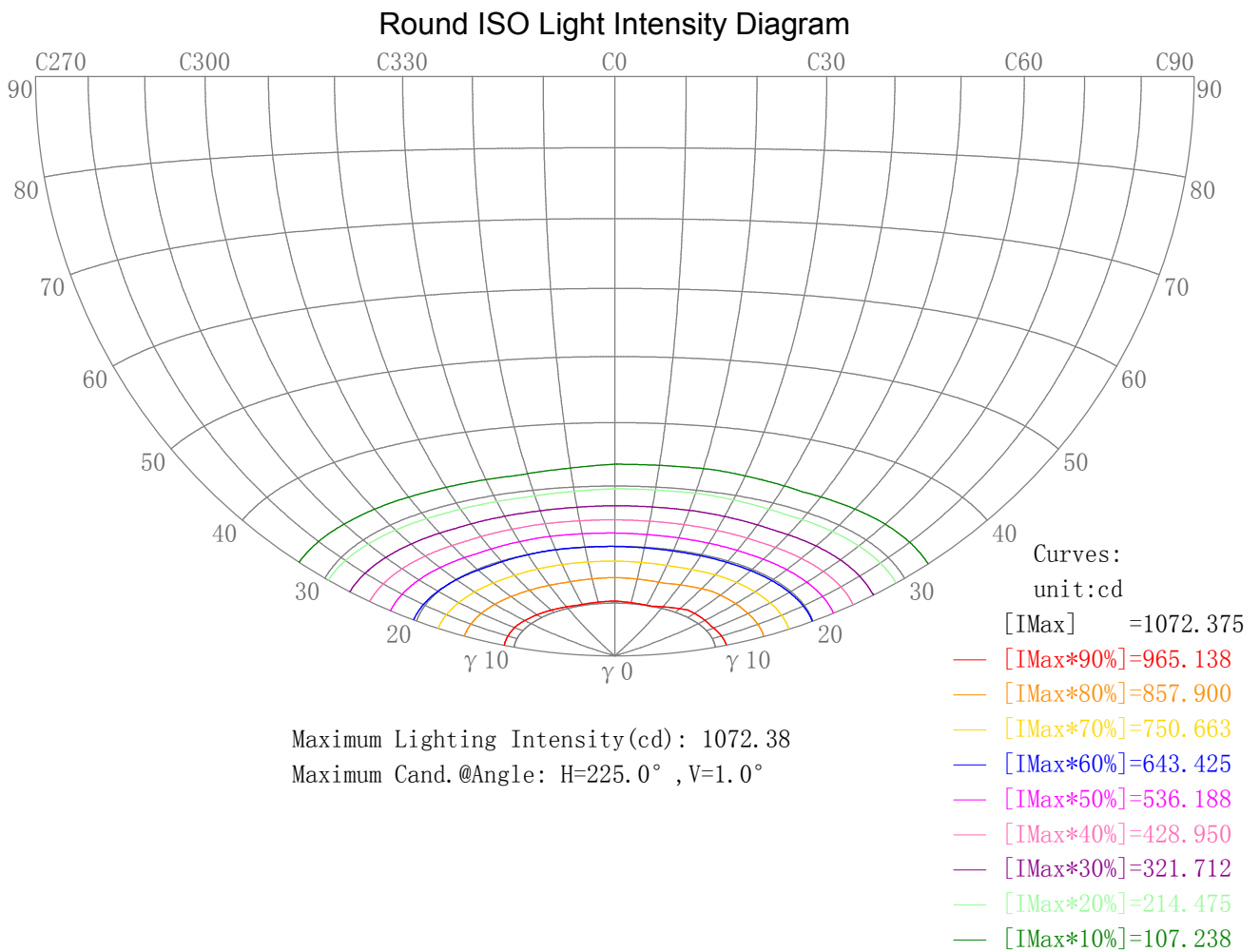

# IES Indoor Report

Photometric Filename:AW12540 8W 1202C9 3090 ZHT35-36D 200.IES

## Plane ISO-Illuminance Diagram

Lum. Name: AW12540	Lum. Catalog: Down Light	Test ID:
Lamp Name: 1202C9	Lamp Catalog: COB	Test Lab: Test
Manufacture: -	Test Machine: GON-2000	Test Date: 2023/06/29

Plane ISO-Illuminance Curve

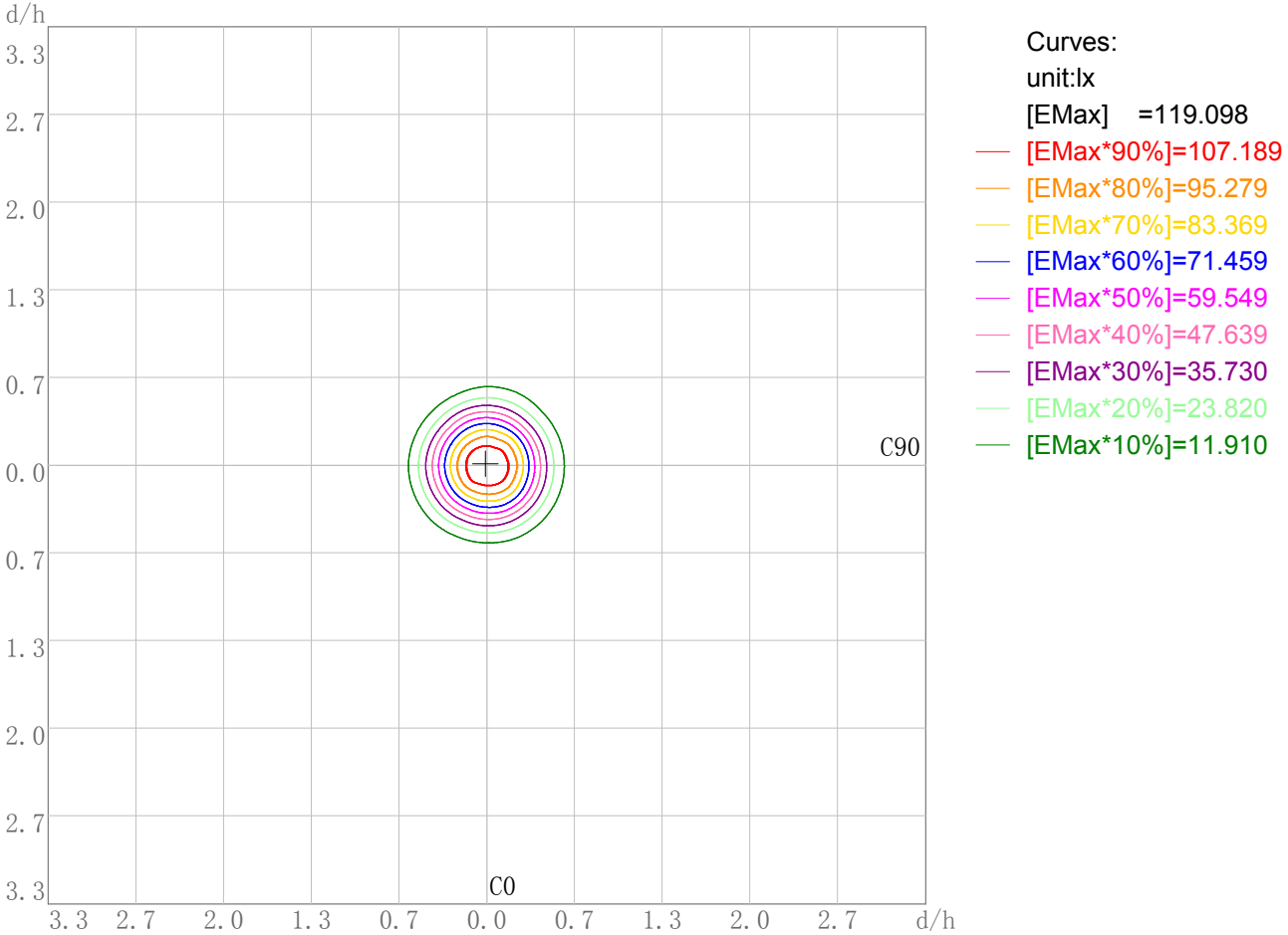

Working Plane Luminaire Mounting Height(m): 3.00  
Working Plane Maximum Illuminance(lx): 119.10  
Working Plane Maximum Illuminance Position(d/h):H-0.0 V-0.0



# IES Indoor Report

Photometric Filename:AW12540 8W 1202C9 3090 ZHT35-36D 200.IES

---

## 3D Plane ISO Illuminance Diagram

Lum. Name: AW12540	Lum. Catalog: Down Light	Test ID:
Lamp Name: 1202C9	Lamp Catalog: COB	Test Lab: Test
Manufacture: -	Test Machine: GON-2000	Test Date: 2023/06/29

### 3D Plane Illuminance Modal

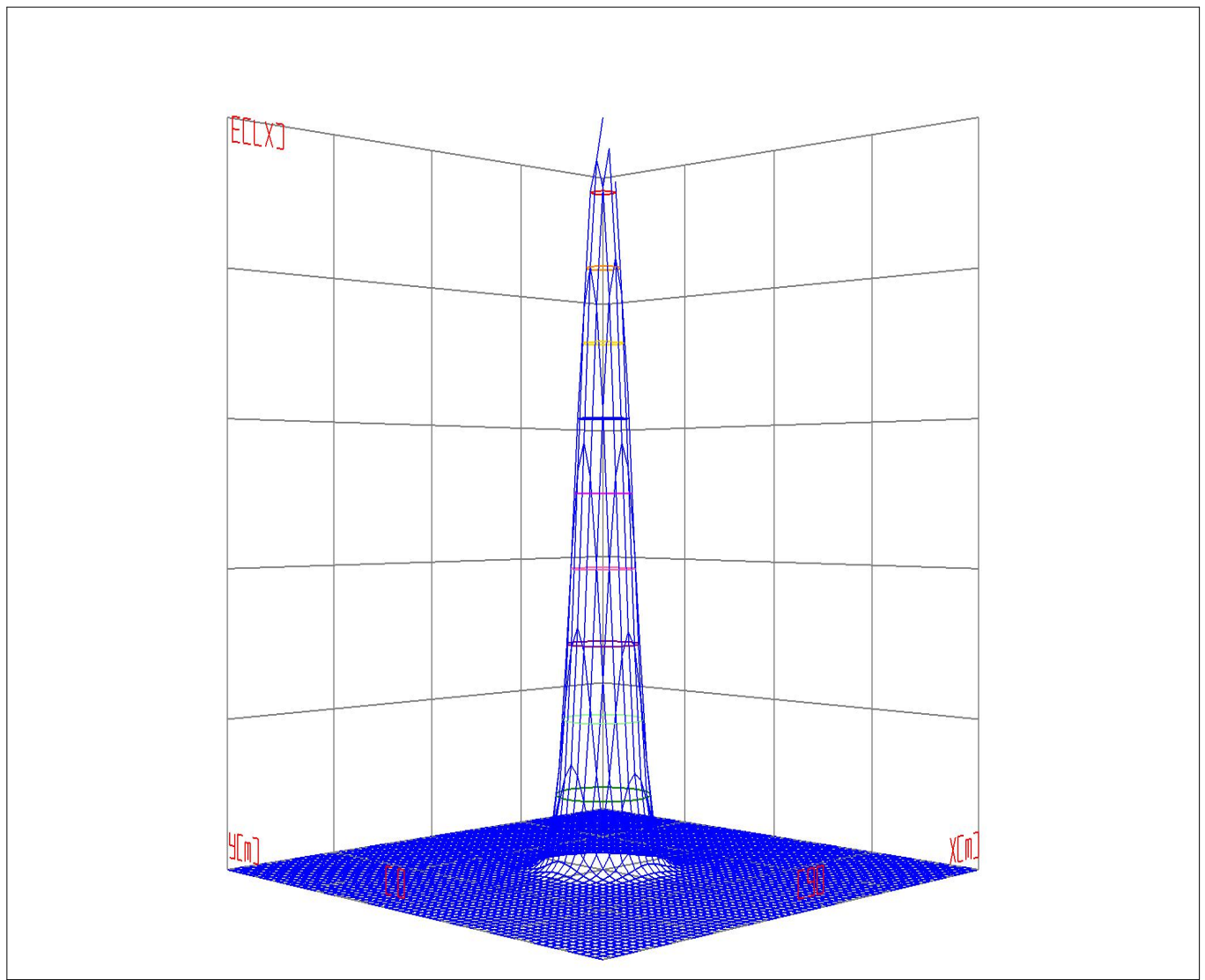

Curves: 3D Model — 90% — 80% — 70% — 60% — 50% — 40% — 30% — 20% — 10% —  
View Angles(deg): 0    Height(m): 3.0    Distance(m): 10.0

---

# IES Indoor Report

Photometric Filename:AW12540 8W 1202C9 3090 ZHT35-36D 200.IES

---

## Space ISO Illuminance Diagram

Lum. Name: AW12540	Lum. Catalog: Down Light	Test ID:
Lamp Name: 1202C9	Lamp Catalog: COB	Test Lab: Test
Manufacture: -	Test Machine: GON-2000	Test Date: 2023/06/29

### Space ISO Illuminance Curve

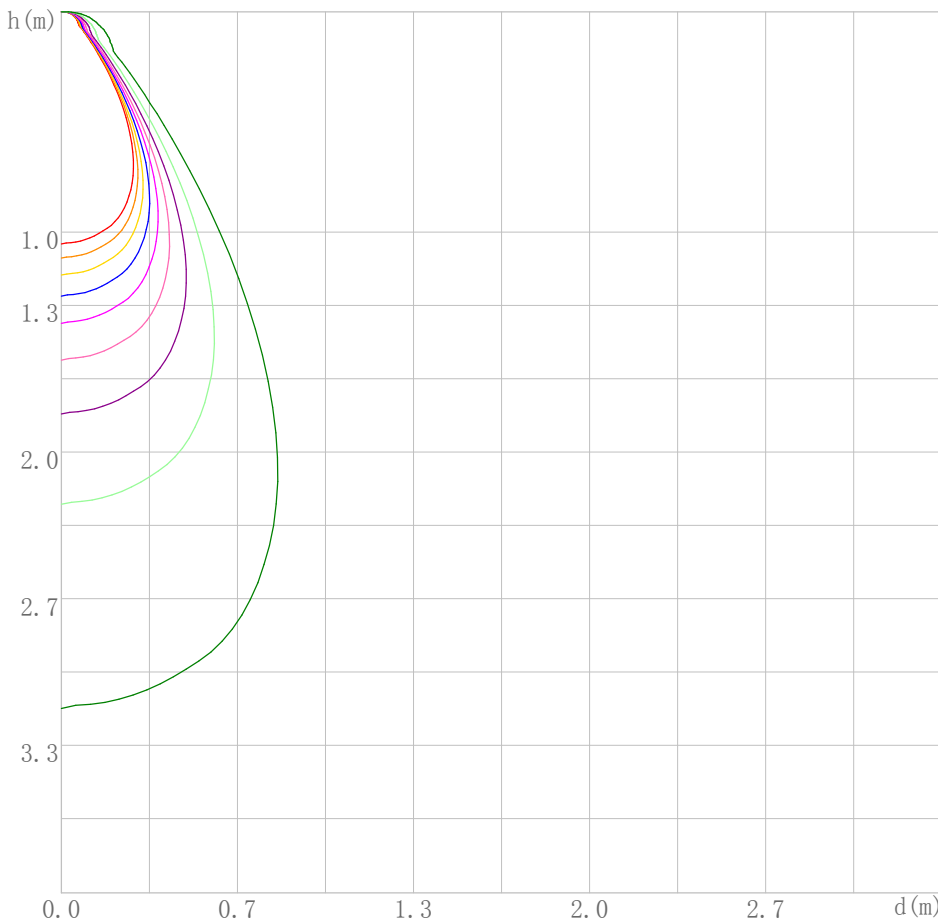

Curves:

[Unit: lx]

[EMax] =1067.932

— [EMax\*90%]=961.139

— [EMax\*80%]=854.346

— [EMax\*70%]=747.552

— [EMax\*60%]=640.759

— [EMax\*50%]=533.966

— [EMax\*40%]=427.173

— [EMax\*30%]=320.380

— [EMax\*20%]=213.586

— [EMax\*10%]=106.793

Space Plane Maximum Illuminance and @Angle:1067.93lx,0.0deg

Plane Maximum Lighting Intensity and @Angle:1067.932cd,0deg

---

# IES Indoor Report

Photometric Filename:AW12540 8W 1202C9 3090 ZHT35-36D 200.IES

## Illuminance-Distance Diagram

Lum. Name: AW12540	Lum. Catalog: Down Light	Test ID:
Lamp Name: 1202C9	Lamp Catalog: COB	Test Lab: Test
Manufacture: -	Test Machine: GON-2000	Test Date: 2023/06/29

Illuminance-Distance Curve

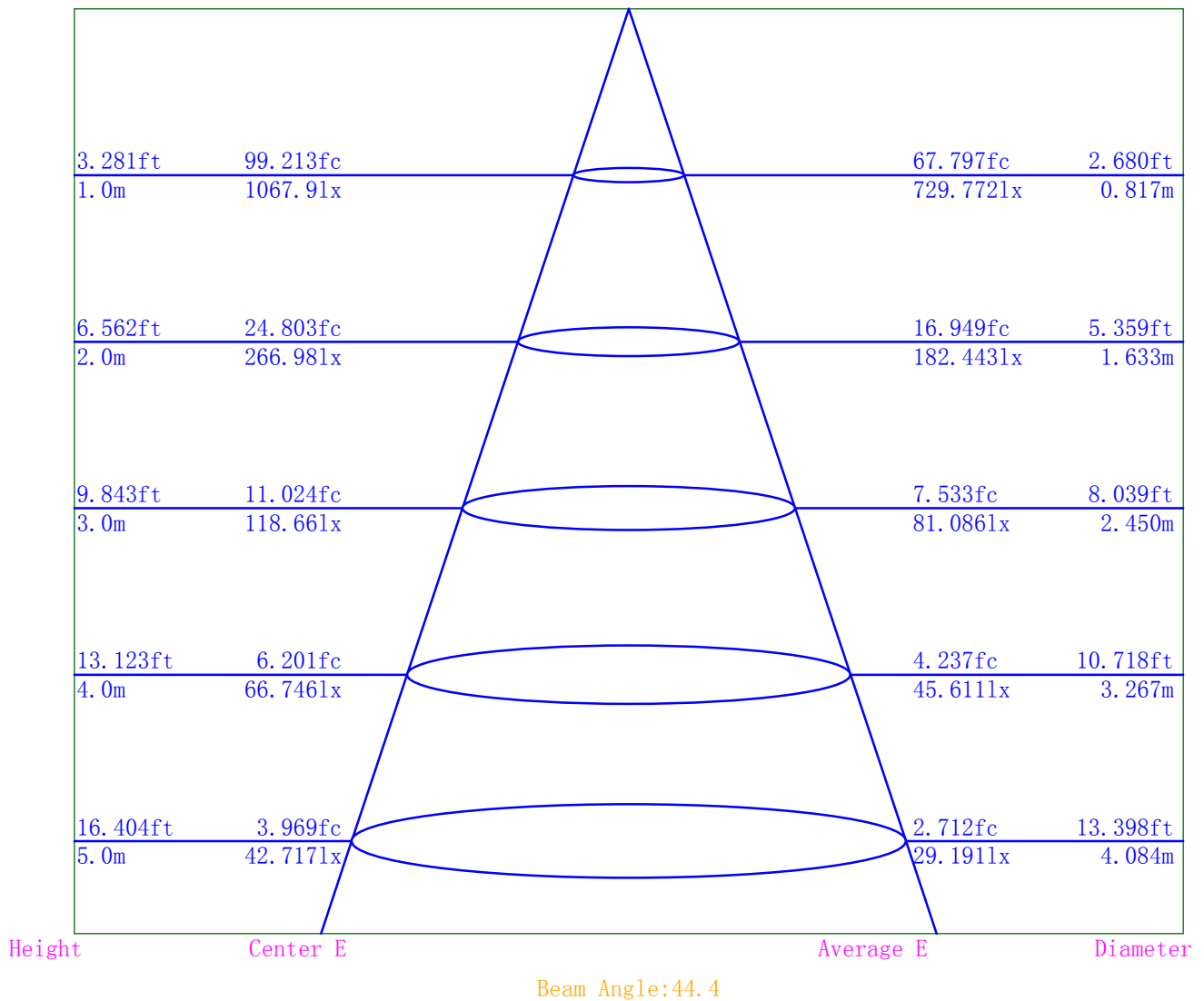

# IES Indoor Report

Photometric Filename:AW12540 8W 1202C9 3090 ZHT35-36D 200.IES

## Indoor Luminance Limiting Curves

Lum. Name: AW12540	Lum. Catalog: Down Light	Test ID:
Lamp Name: 1202C9	Lamp Catalog: COB	Test Lab: Test
Manufacture: -	Test Machine:GON-2000	Test Date: 2023/06/29

Glare Grade Table

GI	Quality	Using Illuminance							
1.15	A	2000	1000	500	<=300				
1.5	B		2000	1000	500	<=300			
1.85	C			2000	1000	500	<=300		
2.2	D				2000	1000	500	<=300	
2.55	E	a				2000	1000	500	<=300
			b	c	d	e	f	g	h

Luminance Table

Gama(deg)	45	50	55	60	65	70	75	80	85
C0	6513	4806	4796	4787	4794	5393	6286	8438	16027
C90	5659	4596	4504	4740	4727	5097	6021	8511	13690

Luminance Limiting Curve

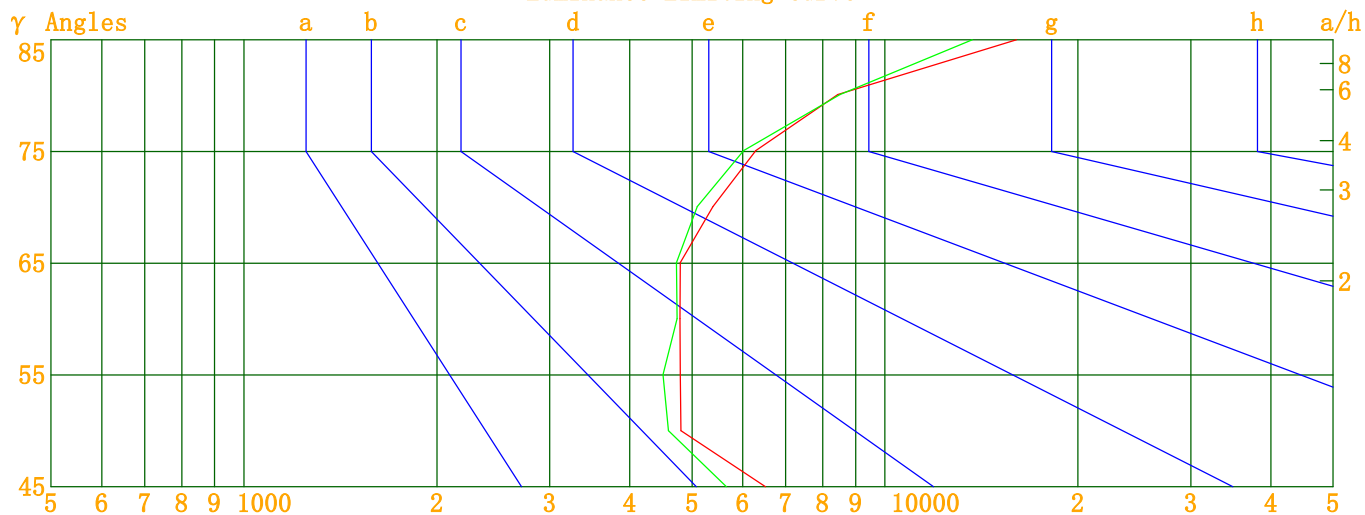

Luminous Size: Length(m)=-0.066 Width(m)=-0.066 Height(m)=0.000 Area(m^2)=0.003421  
 Luminous Type: Without Luminous Side  
 Luminous Curves: C0-C180 Color: — C90-C270 Color: —

# IES Indoor Report

Photometric Filename: AW12540 8W 1202C9 3090 ZHT35-36D 200.IES

## Indoor Budgetary Estimate Table

Lum. Name: AW12540	Lum. Catalog: Down Light	Test ID:
Lamp Name: 1202C9	Lamp Catalog: COB	Test Lab: Test
Manufacture: -	Test Machine: GON-2000	Test Date: 2023/06/29

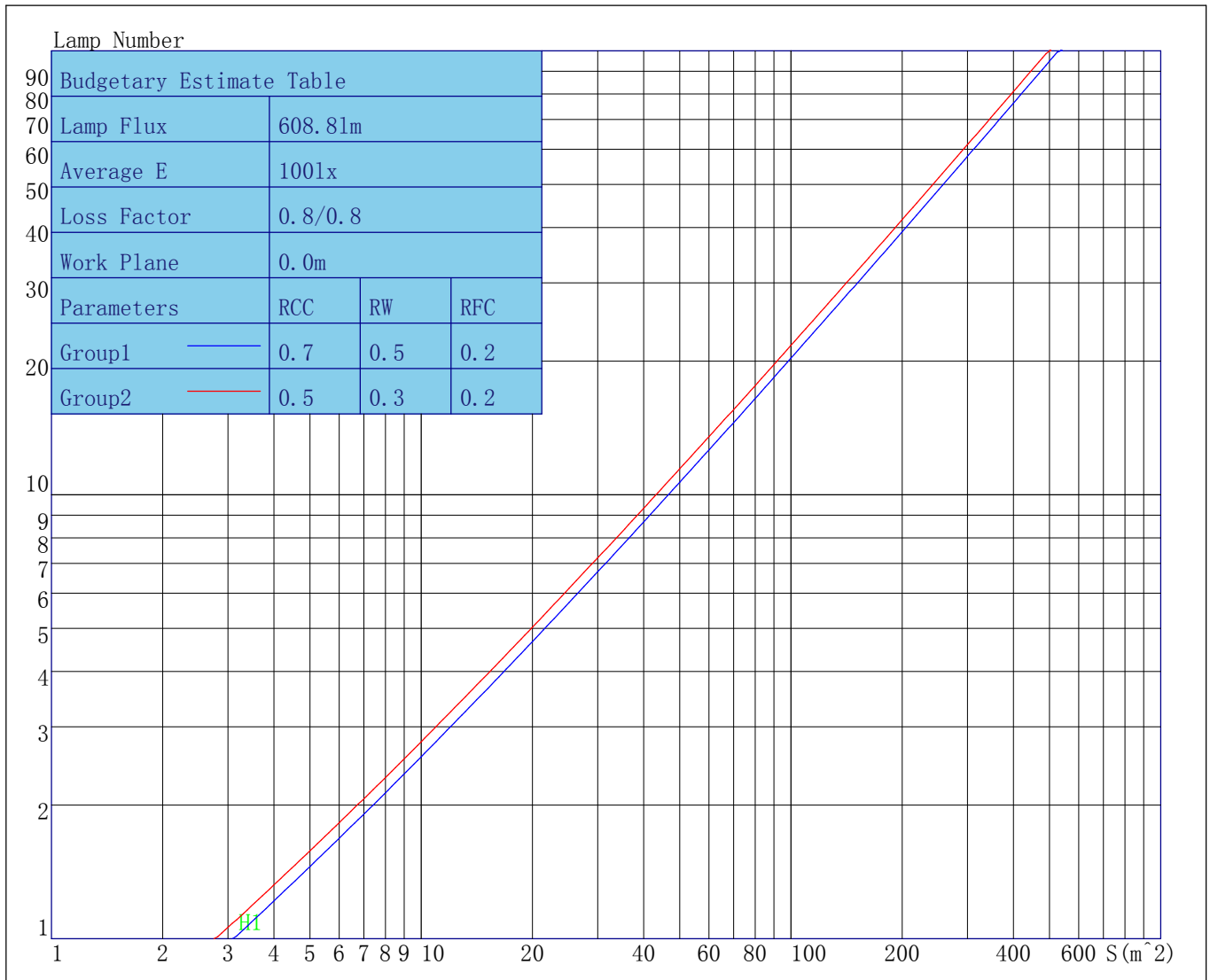

Parameters1: Rhocc = 0.7 Rhow = 0.5 Rhofc = 0.2 LLF = 0.8  
 Parameters2: Rhocc = 0.5 Rhow = 0.3 Rhofc = 0.2 LLF = 0.8  
 Average Illuminance(lx): 100 Cavity Height: H1(m) = 2

# IES Indoor Report

Photometric Filename:AW12540 8W 1202C9 3090 ZHT35-36D 200.IES

---

## Indoor Coefficient of Utilization Table

Lum. Name: AW12540	Lum. Catalog: Down Light	Test ID:
Lamp Name: 1202C9	Lamp Catalog: COB	Test Lab: Test
Manufacture: -	Test Machine:GON-2000	Test Date: 2023/06/29

Coefficients of Utilization - Zonal Cavity Method																		
Coef.	Effective Floor Cavity Reflectance RFC=0.20																	
RhoCC (%)	80				70				50			30			10			0
RhoW (%)	70	50	30	10	70	50	30	10	50	30	10	50	30	10	50	30	10	0
RCR	Coefficient of Utilization(%)																	
0	118	118	118	118	115	115	115	115	109	109	109	104	104	104	99	99	99	97
1	113	110	108	106	110	108	106	104	103	102	100	99	98	97	95	94	93	91
2	108	103	100	97	106	102	98	95	98	95	93	94	92	90	91	89	88	86
3	103	97	93	89	101	96	92	88	93	89	87	90	87	85	87	85	83	81
4	99	92	87	83	97	91	86	83	88	84	81	86	83	80	84	81	79	77
5	95	87	82	78	93	86	81	78	84	80	77	82	79	76	80	77	75	73
6	91	83	78	74	89	82	77	73	80	76	73	79	75	72	77	74	71	70
7	87	79	74	70	86	78	73	70	77	72	69	75	71	68	74	70	68	67
8	84	75	70	66	82	75	70	66	73	69	66	72	68	65	71	67	65	63
9	80	72	67	63	79	71	66	63	70	66	63	69	65	62	68	65	62	61
10	77	69	64	60	76	68	63	60	67	63	60	66	62	60	66	62	59	58

---

# IES Indoor Report

Photometric Filename:AW12540 8W 1202C9 3090 ZHT35-36D 200.IES

## Unified Glare Rating Table

Lum. Name: AW12540	Lum. Catalog: Down Light	Test ID:
Lamp Name: 1202C9	Lamp Catalog: COB	Test Lab: Test
Manufacture: -	Test Machine:GON-2000	Test Date: 2023/06/29

## Unified Glare Rating Table

Ceiling RCC	0.70	0.70	0.50	0.50	0.30	0.70	0.70	0.50	0.50	0.30
Wall RW	0.50	0.30	0.50	0.30	0.30	0.50	0.30	0.50	0.30	0.30
Floor RFC	0.20	0.20	0.20	0.20	0.20	0.20	0.20	0.20	0.20	0.20
Room Size	Vewed crosswise					Vewed endwise				
X=2H Y=2H	13.1	14.0	13.6	14.4	14.8	13.2	14.1	13.6	14.5	14.9
Y=3H	13.8	14.6	14.2	15.0	15.4	14.0	14.8	14.5	15.2	15.7
Y=4H	14.4	15.1	14.8	15.5	16.0	14.7	15.4	15.2	15.9	16.3
Y=6H	15.2	15.9	15.7	16.4	16.8	15.6	16.3	16.1	16.7	17.2
Y=8H	15.8	16.4	16.3	16.9	17.4	16.1	16.8	16.6	17.3	17.7
Y=12H	16.6	17.2	17.1	17.6	18.2	16.8	17.4	17.3	17.9	18.4
X=4H Y=2H	13.1	13.8	13.5	14.2	14.7	13.3	14.1	13.8	14.5	14.9
Y=3H	13.9	14.6	14.4	15.0	15.5	14.5	15.1	15.0	15.6	16.1
Y=4H	14.7	15.3	15.2	15.8	16.3	15.4	16.0	15.9	16.4	17.0
Y=6H	15.9	16.4	16.4	16.9	17.4	16.6	17.1	17.1	17.6	18.1
Y=8H	16.6	17.1	17.1	17.6	18.1	17.3	17.7	17.8	18.3	18.8
Y=12H	17.6	18.0	18.2	18.5	19.1	18.1	18.5	18.7	19.0	19.6
X=8H Y=4H	14.9	15.4	15.5	15.9	16.4	15.8	16.2	16.3	16.7	17.3
Y=6H	16.3	16.7	16.9	17.3	17.8	17.3	17.6	17.8	18.2	18.8
Y=8H	17.3	17.6	17.8	18.1	18.7	18.2	18.5	18.8	19.1	19.6
Y=12H	18.5	18.8	19.1	19.3	20.0	19.2	19.5	19.8	20.1	20.7
X=12H Y=4H	15.0	15.4	15.5	15.9	16.5	15.9	16.3	16.4	16.8	17.4
Y=6H	16.5	16.8	17.1	17.3	17.9	17.5	17.8	18.1	18.3	18.9
Y=8H	17.5	17.8	18.1	18.3	19.0	18.5	18.8	19.1	19.3	20.0
Variations with the objerver position at spacings										
S=1.0H	0.1/-0.1					0.1/-0.1				
S=1.5H	0.1/-0.2					0.1/-0.1				
S=2.0H	0.2/-0.4					0.1/-0.1				
Reduced UGR Table:										
Nordic Standard Table:	BKO					BKO				
Correction Value	3.5					3.9				

o the CIE Pub. 117, data has been corrected, refers to the lamp's lumens 8.2flm.

# IES Indoor Report

Photometric Filename:AW12540 8W 1202C9 3090 ZHT35-36D 200.IES

## Candela Tabulation

V/H	C0.0	C22.5	C45.0	C67.5	C90.0	C112.5	C135.0	C157.5	C180.0	C202.5	C225.0	C247.5
$\gamma$ 0.0	1067.93	1067.93	1067.93	1067.93	1067.93	1067.93	1067.93	1067.93	1067.93	1067.93	1067.93	1067.93
$\gamma$ 1.0	1059.33	1056.63	1072.30	1072.13	1070.75	1071.44	1071.29	1070.83	1059.46	1056.77	1072.38	1070.76
$\gamma$ 2.0	1057.31	1054.35	1070.05	1070.51	1070.13	1071.31	1071.00	1070.31	1058.64	1054.86	1070.67	1068.84
$\gamma$ 3.0	1053.60	1050.36	1065.54	1067.22	1067.67	1069.76	1069.08	1068.07	1056.38	1051.80	1067.55	1066.25
$\gamma$ 4.0	1047.86	1044.49	1059.05	1061.02	1062.71	1066.76	1065.35	1063.11	1052.49	1047.03	1063.38	1062.16
$\gamma$ 5.0	1039.48	1036.50	1050.45	1052.34	1055.32	1061.04	1059.43	1055.48	1046.72	1040.58	1058.20	1056.25
$\gamma$ 6.0	1028.84	1026.41	1040.39	1041.45	1045.73	1052.99	1050.99	1045.30	1038.01	1032.03	1051.12	1047.85
$\gamma$ 7.0	1016.44	1014.27	1028.89	1028.59	1033.78	1041.65	1040.14	1032.72	1026.10	1021.25	1041.54	1036.51
$\gamma$ 8.0	1002.21	1000.02	1015.72	1014.08	1019.88	1027.37	1026.98	1017.99	1011.10	1008.22	1028.49	1022.78
$\gamma$ 9.0	986.72	983.71	1001.00	998.26	1004.48	1009.89	1012.17	1001.49	993.80	992.37	1012.27	1006.23
$\gamma$ 10.0	971.63	964.81	984.46	980.44	987.04	990.73	995.52	983.29	974.32	973.72	994.00	988.00
$\gamma$ 11.0	954.45	943.35	965.73	960.57	967.47	968.95	976.97	963.41	952.44	952.31	972.66	968.18
$\gamma$ 12.0	932.03	919.92	944.10	938.39	945.56	944.75	955.81	940.99	928.62	928.44	948.67	946.29
$\gamma$ 13.0	906.37	894.47	918.65	913.56	920.15	918.16	931.92	916.16	903.05	902.03	921.53	921.59
$\gamma$ 14.0	876.90	866.35	889.03	884.44	889.82	888.25	904.35	888.65	874.51	872.56	890.01	892.44
$\gamma$ 15.0	844.02	834.77	855.21	850.97	854.70	854.40	872.68	858.09	842.64	839.62	854.22	857.41
$\gamma$ 16.0	807.52	799.62	815.82	812.41	814.70	817.48	837.17	824.86	807.83	802.77	815.05	817.95
$\gamma$ 17.0	768.94	761.47	771.91	769.59	771.81	777.91	798.17	788.84	769.37	762.55	773.81	775.72
$\gamma$ 18.0	728.45	721.49	725.93	725.74	728.62	737.77	756.68	750.64	729.08	720.49	731.99	733.24
$\gamma$ 19.0	686.38	679.55	679.13	680.93	685.57	697.24	713.93	710.75	687.73	677.87	690.59	691.32
$\gamma$ 20.0	642.54	634.59	630.79	633.74	640.80	654.65	669.53	668.16	645.90	634.89	648.66	649.71
$\gamma$ 21.0	596.51	587.17	580.42	584.59	593.79	609.51	622.86	622.59	602.85	591.13	606.05	607.41
$\gamma$ 22.0	548.37	538.76	529.71	534.88	545.01	562.19	574.12	574.80	558.43	545.80	561.69	563.76
$\gamma$ 23.0	500.24	490.45	478.79	484.82	494.77	512.63	523.53	524.85	510.57	498.20	515.67	518.89
$\gamma$ 24.0	451.34	443.08	429.13	435.71	443.96	461.13	471.99	473.75	460.99	448.89	467.33	471.63
$\gamma$ 25.0	403.86	396.65	380.65	387.18	393.72	409.51	420.34	422.41	410.77	399.11	417.77	422.90
$\gamma$ 26.0	357.32	351.43	333.14	339.65	344.93	358.25	369.86	371.79	360.50	350.03	368.96	373.45
$\gamma$ 27.0	313.12	308.64	288.75	294.12	298.73	309.66	321.16	323.28	311.67	302.81	321.55	324.80
$\gamma$ 28.0	271.97	268.52	247.34	251.36	255.61	264.22	275.15	277.39	265.65	258.25	275.73	278.17
$\gamma$ 29.0	233.88	231.22	209.36	212.40	216.09	223.18	232.69	234.53	222.64	217.28	232.84	234.25
$\gamma$ 30.0	199.13	197.09	174.75	177.65	180.58	186.21	193.96	195.97	183.80	180.25	194.09	194.95
$\gamma$ 31.0	167.76	166.29	144.83	148.04	149.63	154.77	159.80	161.58	149.94	147.43	159.84	159.87
$\gamma$ 32.0	140.55	139.27	119.50	122.64	123.45	127.26	131.04	132.27	121.50	119.49	130.26	130.25
$\gamma$ 33.0	117.13	116.17	98.71	101.39	101.80	104.46	107.57	108.44	97.85	95.89	105.46	105.60
$\gamma$ 34.0	97.38	96.89	81.65	83.59	83.91	85.85	88.19	88.84	78.22	76.19	85.28	85.08
$\gamma$ 35.0	80.52	80.92	67.76	68.92	69.35	71.17	72.19	72.65	62.03	59.78	68.70	68.42
$\gamma$ 36.0	67.23	67.68	56.30	57.25	57.65	58.58	59.23	59.61	48.09	45.89	54.88	54.56
$\gamma$ 37.0	55.70	56.73	46.64	47.35	47.65	48.11	48.45	48.94	37.00	34.32	43.40	42.88
$\gamma$ 38.0	46.76	47.61	38.41	39.01	39.47	39.69	39.75	40.02	27.69	25.46	33.82	33.54
$\gamma$ 39.0	39.20	40.14	31.91	32.30	32.85	33.08	32.76	32.73	21.31	19.84	26.34	25.95
$\gamma$ 40.0	33.43	33.97	26.92	27.46	27.77	27.88	27.42	27.57	17.58	16.37	21.29	20.68
$\gamma$ 41.0	28.45	28.86	23.22	23.62	24.02	24.01	23.68	23.68	14.84	13.72	17.69	17.29
$\gamma$ 42.0	24.56	24.70	20.48	20.60	20.90	20.80	20.68	20.36	12.58	11.54	14.38	14.26
$\gamma$ 43.0	21.13	21.12	18.01	17.76	18.01	18.15	17.68	17.52	10.42	9.67	11.83	11.64
$\gamma$ 44.0	17.99	18.25	15.61	15.32	15.58	15.60	15.23	15.04	8.48	8.14	9.61	9.44
$\gamma$ 45.0	15.76	15.78	13.75	13.62	13.69	13.35	13.39	13.32	7.41	7.25	7.91	7.54
$\gamma$ 46.0	13.70	13.64	12.41	12.12	12.12	12.07	12.13	11.91	6.27	6.71	6.50	6.18



# IES Indoor Report

Photometric Filename:AW12540 8W 1202C9 3090 ZHT35-36D 200.IES

## Candela Tabulation - (Cont.)

V/H	C0.0	C22.5	C45.0	C67.5	C90.0	C112.5	C135.0	C157.5	C180.0	C202.5	C225.0	C247.5
γ 47.0	12.13	12.26	11.49	11.32	11.22	11.26	11.39	11.27	5.94	6.03	5.93	5.80
γ 48.0	11.18	11.39	10.94	10.65	10.84	10.71	10.94	10.92	5.61	5.47	5.53	5.39
γ 49.0	11.01	10.87	10.69	10.48	10.44	10.33	10.63	10.48	5.21	5.19	5.19	5.16
γ 50.0	10.57	10.63	10.15	10.28	10.11	9.97	10.31	10.20	4.85	4.96	4.88	4.84
γ 51.0	10.24	10.32	9.74	9.69	9.77	9.75	9.96	9.77	4.34	4.58	4.53	4.39
γ 52.0	10.05	9.98	9.57	9.40	9.29	9.52	9.62	9.30	4.21	4.32	4.52	4.11
γ 53.0	9.58	9.74	9.33	9.06	9.07	9.17	9.36	9.10	4.11	4.22	4.08	4.12
γ 54.0	9.43	9.42	9.22	8.92	8.99	8.99	9.24	8.98	4.14	3.93	4.05	3.81
γ 55.0	9.41	9.11	8.69	8.77	8.84	8.88	9.05	8.81	3.91	3.73	3.83	3.54
γ 56.0	9.15	9.02	8.45	8.81	8.65	8.74	8.91	8.74	3.78	3.56	3.44	3.29
γ 57.0	9.01	8.84	8.15	8.37	8.56	8.59	8.75	8.67	3.76	3.28	3.24	3.19
γ 58.0	8.70	8.64	8.17	8.40	8.38	8.33	8.41	8.58	3.47	3.21	3.22	3.13
γ 59.0	8.50	8.49	8.15	8.19	8.21	8.26	8.12	8.30	3.42	3.10	2.97	2.85
γ 60.0	8.19	8.23	8.00	8.05	8.11	8.05	7.94	8.25	3.04	2.97	2.72	2.97
γ 61.0	8.08	8.01	7.84	7.88	7.91	7.98	7.78	7.78	2.96	2.94	2.94	2.59
γ 62.0	7.78	7.78	7.60	7.76	7.59	7.72	7.69	7.59	2.60	2.73	2.66	2.36
γ 63.0	7.78	7.52	7.36	7.37	7.22	7.89	7.55	7.35	2.63	2.40	2.53	2.37
γ 64.0	7.44	7.50	7.15	7.31	6.88	7.43	7.14	7.41	2.32	2.20	2.42	2.32
γ 65.0	6.93	7.31	6.92	6.94	6.83	7.19	6.80	7.28	2.13	2.01	2.16	2.13
γ 66.0	6.86	6.92	6.77	6.89	6.67	6.82	6.59	6.81	2.17	1.81	2.18	2.00
γ 67.0	6.55	6.68	6.38	6.75	6.35	6.59	6.65	6.60	2.30	1.88	1.89	1.92
γ 68.0	6.44	6.62	6.34	6.64	6.15	6.53	6.46	6.66	1.86	1.95	2.01	1.94
γ 69.0	6.25	6.50	6.06	6.44	6.05	6.66	6.33	6.28	1.76	1.76	1.81	1.76
γ 70.0	6.31	6.27	6.00	6.33	5.96	6.32	6.36	6.10	1.98	1.59	1.95	1.80
γ 71.0	6.11	6.16	5.84	6.22	5.97	6.12	6.13	6.10	1.77	1.66	1.71	1.61
γ 72.0	5.95	6.09	5.87	6.16	5.69	5.66	5.85	6.13	1.75	1.59	1.78	1.64
γ 73.0	5.68	5.97	5.68	5.80	5.55	5.91	5.82	5.93	2.00	1.53	1.93	1.66
γ 74.0	5.68	5.91	5.57	5.61	5.37	5.64	5.69	5.89	1.96	1.72	1.99	1.52
γ 75.0	5.57	5.87	5.54	5.65	5.33	5.38	5.61	5.51	2.19	1.67	1.91	1.60
γ 76.0	5.39	5.76	5.37	5.55	5.43	5.48	5.43	5.35	2.27	1.60	1.83	1.60
γ 77.0	5.37	5.65	5.42	5.48	5.16	5.30	5.29	5.04	2.10	1.74	1.99	1.54
γ 78.0	5.31	5.47	5.14	5.10	4.97	5.16	5.16	4.93	2.03	1.84	1.97	1.71
γ 79.0	5.01	5.28	5.18	5.03	4.91	5.02	5.10	4.93	1.98	1.67	1.82	1.89
γ 80.0	5.01	5.22	5.15	5.09	5.06	5.15	4.94	4.87	1.90	1.50	1.92	1.53
γ 81.0	4.82	5.12	4.73	4.74	4.99	4.72	4.95	4.93	2.04	1.68	2.04	1.74
γ 82.0	4.57	5.01	4.57	4.73	4.71	4.63	4.74	4.73	2.03	1.86	2.19	1.84
γ 83.0	4.76	5.02	4.78	4.50	4.53	4.61	4.71	4.66	2.32	1.77	2.09	1.87
γ 84.0	4.57	4.95	4.72	4.33	4.32	4.53	4.51	4.57	2.33	1.75	2.02	1.82
γ 85.0	4.78	4.75	4.44	4.30	4.08	4.71	4.41	4.35	2.09	1.85	2.10	1.92
γ 86.0	4.49	4.45	4.26	4.57	4.11	4.77	4.38	4.41	2.26	1.99	1.98	2.03
γ 87.0	4.43	4.40	4.02	4.21	4.20	4.55	4.09	4.15	2.19	2.02	2.14	2.13
γ 88.0	4.26	4.47	4.12	4.33	4.14	4.54	3.98	4.05	2.14	1.89	2.19	2.01
γ 89.0	4.19	4.42	4.21	4.08	4.03	4.41	4.05	4.07	2.21	2.00	2.09	2.25
γ 90.0	4.18	4.34	3.89	4.42	4.06	4.31	4.08	4.07	2.32	2.29	2.33	2.41
γ 91.0	4.21	4.23	3.89	4.22	3.99	4.29	3.95	4.09	2.15	2.30	2.45	2.24
γ 92.0	4.28	4.18	3.98	4.13	3.82	4.17	3.85	4.06	2.22	2.26	2.28	2.38
γ 93.0	4.06	4.00	3.78	3.99	3.90	4.27	3.79	4.06	2.15	2.36	2.05	2.17

# IES Indoor Report

Photometric Filename:AW12540 8W 1202C9 3090 ZHT35-36D 200.IES

## Candela Tabulation - (Cont.)

V/H	C0.0	C22.5	C45.0	C67.5	C90.0	C112.5	C135.0	C157.5	C180.0	C202.5	C225.0	C247.5
γ 94.0	4.00	3.91	3.80	3.93	3.91	3.97	3.74	4.05	2.27	2.38	2.21	2.22
γ 95.0	3.72	3.79	3.71	4.07	3.89	4.01	3.55	3.86	2.05	2.30	2.24	2.29
γ 96.0	3.78	3.66	3.51	4.03	3.73	3.69	3.42	3.56	2.39	2.38	2.34	2.33
γ 97.0	3.85	3.75	3.43	3.69	3.73	3.93	3.43	3.39	2.49	2.53	2.38	2.25
γ 98.0	3.70	3.66	3.77	3.86	3.83	3.73	3.39	3.75	2.35	2.54	2.38	2.27
γ 99.0	3.46	3.64	3.61	3.70	3.76	3.87	3.46	3.79	2.47	2.70	2.50	2.34
γ 100.0	3.46	3.71	3.46	3.59	3.78	3.57	3.42	3.76	2.44	2.71	2.55	2.28
γ 101.0	3.38	3.57	3.31	3.65	3.84	3.53	3.37	3.65	2.77	2.54	2.58	2.61
γ 102.0	3.31	3.59	3.13	3.55	3.68	3.54	3.48	3.59	2.41	2.56	2.43	2.52
γ 103.0	3.41	3.56	3.21	3.56	3.57	3.48	3.45	3.45	2.56	2.62	2.54	2.54
γ 104.0	3.29	3.56	3.03	3.40	3.69	3.52	3.35	3.40	2.59	2.75	2.60	2.43
γ 105.0	3.20	3.51	3.02	3.35	3.65	3.46	3.21	3.30	2.57	2.80	2.45	2.29
γ 106.0	3.21	3.35	2.89	3.37	3.56	3.61	3.15	3.18	2.49	2.59	2.47	2.37
γ 107.0	3.41	3.32	3.00	3.26	3.48	3.28	3.22	3.15	2.39	2.41	2.51	2.20
γ 108.0	3.18	3.34	2.99	3.35	3.54	3.64	3.02	3.12	2.40	2.48	2.60	2.23
γ 109.0	3.29	3.27	2.83	3.22	3.52	3.25	2.71	3.07	2.57	2.62	2.69	2.38
γ 110.0	3.26	2.97	2.78	3.03	3.57	3.20	2.83	3.08	2.63	2.68	2.63	2.25
γ 111.0	3.22	2.97	2.71	3.12	3.47	3.32	2.86	3.03	2.63	2.80	2.65	2.29
γ 112.0	3.19	3.17	2.82	3.22	3.36	3.32	2.85	3.02	2.93	2.74	2.47	2.20
γ 113.0	3.51	3.21	2.95	3.18	3.39	3.22	2.79	2.89	2.85	2.57	2.43	2.11
γ 114.0	3.28	3.17	3.00	3.16	3.42	3.41	2.70	3.06	2.58	2.56	2.65	2.29
γ 115.0	3.12	3.07	3.00	3.38	3.31	3.44	2.73	3.24	2.72	2.56	2.64	2.38
γ 116.0	2.83	3.06	2.92	3.07	3.23	2.91	2.67	3.36	2.72	2.63	2.33	2.32
γ 117.0	3.09	3.04	2.81	3.14	3.15	3.31	2.58	3.35	2.68	2.62	2.34	2.43
γ 118.0	2.88	2.95	2.71	3.10	3.08	3.27	2.53	3.13	2.60	2.58	2.45	2.33
γ 119.0	3.00	3.04	2.73	3.03	3.02	3.07	2.53	3.06	2.44	2.62	2.68	2.05
γ 120.0	2.96	2.98	2.78	3.15	3.12	3.11	2.53	3.16	2.69	2.61	2.58	2.26
γ 121.0	2.83	2.98	2.71	3.00	3.09	3.19	2.44	2.98	2.72	2.66	2.66	2.37
γ 122.0	2.74	2.97	2.82	2.90	3.05	2.95	2.50	2.93	2.58	2.54	2.74	2.45
γ 123.0	3.07	2.89	2.90	3.10	2.92	2.99	2.56	2.80	2.52	2.45	2.60	2.30
γ 124.0	2.75	2.94	2.84	2.96	2.99	3.20	2.52	2.76	2.78	2.59	2.74	2.36
γ 125.0	2.72	2.90	2.80	3.02	3.03	2.94	2.51	2.90	2.41	2.74	2.92	2.39
γ 126.0	2.87	2.79	2.62	2.83	2.96	2.92	2.68	3.00	2.72	2.70	2.82	2.54
γ 127.0	2.80	2.86	2.59	2.93	2.79	3.03	2.52	2.93	2.71	2.66	2.92	2.38
γ 128.0	3.06	2.94	2.66	3.09	2.88	3.03	2.43	2.68	2.68	2.69	2.82	2.48
γ 129.0	2.83	2.77	2.90	2.96	2.97	3.10	2.44	2.70	2.56	2.59	2.88	2.45
γ 130.0	3.06	2.73	2.75	3.20	3.06	3.06	2.51	2.88	2.69	2.58	2.98	2.38
γ 131.0	3.04	2.95	2.60	3.14	3.09	2.98	2.53	2.88	2.80	2.63	2.96	2.38
γ 132.0	3.18	3.08	2.56	2.91	3.10	3.23	2.38	3.03	2.94	2.70	3.26	2.47
γ 133.0	2.90	3.04	2.63	3.09	2.99	3.07	2.35	3.08	2.97	2.71	3.08	2.32
γ 134.0	2.96	3.12	2.65	3.20	3.25	3.02	2.44	2.87	2.70	2.80	2.89	2.50
γ 135.0	3.00	3.13	2.61	3.27	3.30	3.14	2.63	2.85	2.79	2.98	2.80	2.67
γ 136.0	3.06	3.01	2.68	3.03	3.19	3.12	2.81	2.98	2.69	2.94	3.04	2.68
γ 137.0	3.18	3.10	2.74	2.87	3.14	2.88	2.79	3.23	2.61	2.99	3.10	2.69
γ 138.0	3.24	3.13	2.97	3.17	3.17	3.07	2.85	3.08	2.75	3.05	2.95	2.69
γ 139.0	3.23	3.12	2.89	3.18	3.26	3.43	2.91	3.25	2.83	3.03	2.89	2.57
γ 140.0	3.32	3.24	3.07	3.19	3.30	3.32	2.96	3.31	2.87	3.07	3.22	2.71

# IES Indoor Report

Photometric Filename:AW12540 8W 1202C9 3090 ZHT35-36D 200.IES

## Candela Tabulation - (Cont.)

V/H	C0. 0	C22. 5	C45. 0	C67. 5	C90. 0	C112. 5	C135. 0	C157. 5	C180. 0	C202. 5	C225. 0	C247. 5
γ 141. 0	3.44	3.20	3.12	3.27	3.39	3.34	2.98	3.21	3.15	3.15	3.25	2.84
γ 142. 0	3.26	3.13	2.97	3.30	3.31	3.35	2.81	3.15	2.96	3.08	3.10	2.96
γ 143. 0	3.35	3.21	3.02	3.30	3.17	3.23	3.05	3.22	3.29	2.96	3.29	3.02
γ 144. 0	3.40	3.21	3.06	3.21	3.30	3.60	3.31	3.30	3.17	3.02	3.09	3.04
γ 145. 0	3.28	3.18	3.14	3.17	3.46	3.42	3.22	3.40	3.30	3.01	2.95	2.91
γ 146. 0	3.41	3.38	3.19	3.30	3.44	3.46	3.20	3.36	3.40	3.03	3.05	2.95
γ 147. 0	3.23	3.46	3.28	3.28	3.39	3.57	3.33	3.54	3.31	3.18	3.01	3.23
γ 148. 0	3.41	3.38	3.36	3.43	3.40	3.64	3.46	3.57	3.16	3.27	3.31	3.26
γ 149. 0	3.37	3.37	3.57	3.57	3.41	3.52	3.48	3.70	3.47	3.36	3.48	3.07
γ 150. 0	3.67	3.43	3.51	3.62	3.56	3.66	3.45	3.72	3.57	3.42	3.40	2.97
γ 151. 0	3.66	3.66	3.44	3.37	3.84	3.54	3.50	3.59	3.53	3.54	3.48	3.19
γ 152. 0	3.60	3.68	3.61	3.38	3.81	3.63	3.33	3.57	3.54	3.67	3.50	3.44
γ 153. 0	3.87	3.56	3.61	3.74	3.71	3.59	3.45	3.69	3.57	3.69	3.50	3.38
γ 154. 0	4.24	3.52	3.59	3.81	3.49	3.61	3.67	3.89	3.57	3.83	3.54	3.38
γ 155. 0	4.08	3.48	3.71	3.84	3.62	3.82	3.73	3.77	3.71	3.87	3.46	3.63
γ 156. 0	4.12	3.49	3.88	4.04	3.72	3.76	3.76	3.78	3.98	3.81	3.74	3.59
γ 157. 0	4.69	3.66	4.07	4.20	3.70	3.99	3.70	3.88	3.76	3.89	3.62	3.87
γ 158. 0	4.00	3.87	3.74	4.04	3.71	3.89	3.73	4.09	4.04	3.84	3.54	3.65
γ 159. 0	3.93	3.80	3.78	3.80	3.90	3.99	3.86	4.05	3.90	3.88	3.71	3.69
γ 160. 0	3.81	3.77	3.75	3.80	4.15	4.08	3.90	4.11	3.82	3.97	3.87	3.67
γ 161. 0	3.96	4.00	3.80	3.78	4.05	3.96	3.76	4.20	3.75	3.81	3.67	3.81
γ 162. 0	4.16	4.09	3.91	3.89	3.86	4.14	3.92	4.11	3.99	3.81	3.75	3.67
γ 163. 0	3.83	3.99	3.85	3.83	3.90	4.09	3.94	4.09	4.36	3.88	3.85	3.98
γ 164. 0	4.14	4.01	3.58	3.96	3.92	4.22	3.76	4.16	3.80	3.95	3.89	4.20
γ 165. 0	3.83	4.09	3.88	4.06	3.97	4.27	3.75	4.11	3.97	4.07	4.11	4.17
γ 166. 0	4.09	4.07	3.97	4.19	4.14	4.18	3.96	4.17	4.07	4.05	4.03	4.09
γ 167. 0	4.18	4.10	3.85	4.15	4.09	4.33	4.16	4.25	4.25	4.07	4.15	4.30
γ 168. 0	4.13	4.19	3.74	4.13	4.13	4.20	4.20	4.25	4.12	4.13	4.18	4.19
γ 169. 0	4.39	4.35	3.83	4.39	4.15	4.01	4.13	4.21	3.97	4.11	4.08	4.38
γ 170. 0	4.16	4.39	3.86	4.56	4.18	4.14	3.98	4.33	3.83	4.28	3.99	4.27
γ 171. 0	4.48	4.29	4.00	4.49	4.15	4.14	4.28	4.32	4.05	4.51	4.25	4.36
γ 172. 0	4.31	4.24	4.07	4.41	4.15	4.29	4.56	4.31	4.15	4.59	4.29	4.34
γ 173. 0	4.23	4.40	4.11	4.43	4.01	4.46	4.43	4.18	4.29	4.51	4.37	4.26
γ 174. 0	4.49	4.55	4.25	4.39	3.95	4.35	4.35	4.24	4.38	4.41	4.24	4.45
γ 175. 0	4.57	4.44	4.36	4.33	4.01	4.43	4.28	4.42	4.51	4.42	4.34	4.24
γ 176. 0	4.54	4.40	4.32	4.29	4.16	4.17	4.44	4.50	4.46	4.32	4.52	4.40
γ 177. 0	4.42	4.37	4.31	4.16	4.23	4.39	4.59	4.42	4.29	4.24	4.39	4.50
γ 178. 0	4.70	4.44	4.61	4.64	4.21	4.43	4.52	4.54	4.49	4.28	4.62	4.31
γ 179. 0	4.63	4.54	4.50	4.72	4.31	4.22	4.44	4.53	4.48	4.41	4.40	4.39
γ 180. 0	4.47	4.47	4.47	4.47	4.47	4.47	4.47	4.47	4.47	4.47	4.47	4.47
V/H	C270. 0	C292. 5	C315. 0	C337. 5								
γ 0. 0	1067.93	1067.93	1067.93	1067.93								
γ 1. 0	1068.79	1069.22	1069.05	1068.45								
γ 2. 0	1066.62	1066.77	1067.02	1066.23								
γ 3. 0	1063.58	1063.75	1063.81	1062.82								
γ 4. 0	1059.18	1059.10	1059.10	1057.20								
γ 5. 0	1052.99	1053.12	1052.42	1048.93								

# IES Indoor Report

Photometric Filename:AW12540 8W 1202C9 3090 ZHT35-36D 200.IES

---

## Candela Tabulation - (Cont.)

V/H	C270. 0	C292. 5	C315. 0	C337. 5
$\gamma$ 6. 0	1044. 46	1044. 77	1043. 12	1037. 99
$\gamma$ 7. 0	1033. 08	1034. 21	1030. 85	1023. 95
$\gamma$ 8. 0	1018. 98	1020. 42	1015. 64	1007. 41
$\gamma$ 9. 0	1002. 41	1003. 81	997. 75	989. 10
$\gamma$ 10. 0	984. 40	984. 69	977. 55	968. 91
$\gamma$ 11. 0	964. 84	963. 74	955. 41	947. 04
$\gamma$ 12. 0	943. 30	940. 65	931. 07	923. 41
$\gamma$ 13. 0	919. 53	914. 12	904. 36	897. 57
$\gamma$ 14. 0	891. 79	884. 59	874. 82	869. 23
$\gamma$ 15. 0	859. 31	850. 66	841. 92	838. 11
$\gamma$ 16. 0	821. 83	811. 80	804. 89	804. 24
$\gamma$ 17. 0	781. 11	770. 05	764. 36	767. 76
$\gamma$ 18. 0	739. 40	728. 24	722. 14	729. 75
$\gamma$ 19. 0	697. 78	687. 11	679. 29	689. 46
$\gamma$ 20. 0	656. 30	645. 04	634. 79	646. 45
$\gamma$ 21. 0	614. 45	602. 25	588. 73	600. 86
$\gamma$ 22. 0	570. 89	556. 89	541. 42	552. 98
$\gamma$ 23. 0	525. 69	509. 95	492. 74	503. 53
$\gamma$ 24. 0	478. 74	461. 08	443. 45	452. 70
$\gamma$ 25. 0	429. 90	411. 15	393. 73	401. 76
$\gamma$ 26. 0	380. 45	361. 23	344. 86	351. 52
$\gamma$ 27. 0	331. 47	312. 54	297. 82	303. 35
$\gamma$ 28. 0	283. 91	266. 37	253. 66	257. 42
$\gamma$ 29. 0	239. 46	223. 91	213. 29	215. 87
$\gamma$ 30. 0	199. 31	185. 53	177. 46	179. 16
$\gamma$ 31. 0	163. 57	152. 16	146. 32	147. 17
$\gamma$ 32. 0	132. 70	123. 84	119. 67	120. 01
$\gamma$ 33. 0	107. 39	100. 39	97. 47	97. 37
$\gamma$ 34. 0	86. 82	81. 32	79. 36	78. 99
$\gamma$ 35. 0	69. 72	65. 33	64. 58	64. 21
$\gamma$ 36. 0	55. 55	52. 26	52. 26	51. 83
$\gamma$ 37. 0	43. 58	41. 03	42. 01	41. 32
$\gamma$ 38. 0	33. 91	32. 34	33. 51	32. 58
$\gamma$ 39. 0	26. 53	25. 46	26. 69	25. 76
$\gamma$ 40. 0	21. 42	20. 53	21. 44	20. 74
$\gamma$ 41. 0	17. 88	17. 20	17. 75	17. 23
$\gamma$ 42. 0	14. 85	14. 23	14. 84	14. 41
$\gamma$ 43. 0	12. 03	11. 69	12. 26	11. 88
$\gamma$ 44. 0	9. 54	9. 45	10. 11	9. 77
$\gamma$ 45. 0	7. 80	7. 62	8. 19	7. 86
$\gamma$ 46. 0	6. 65	6. 44	6. 86	6. 55
$\gamma$ 47. 0	6. 04	5. 53	6. 14	5. 86
$\gamma$ 48. 0	5. 61	5. 09	5. 71	5. 43
$\gamma$ 49. 0	5. 16	4. 80	5. 32	5. 02
$\gamma$ 50. 0	4. 80	4. 62	4. 96	4. 74
$\gamma$ 51. 0	4. 44	4. 44	4. 77	4. 57
$\gamma$ 52. 0	4. 31	4. 08	4. 48	4. 39

---

# IES Indoor Report

Photometric Filename:AW12540 8W 1202C9 3090 ZHT35-36D 200.IES

---

## Candela Tabulation - (Cont.)

V/H	C270.0	C292.5	C315.0	C337.5
$\gamma$ 53.0	4.03	3.86	4.16	3.90
$\gamma$ 54.0	3.91	3.88	3.89	3.82
$\gamma$ 55.0	3.87	3.73	3.76	3.53
$\gamma$ 56.0	3.63	3.41	3.47	3.34
$\gamma$ 57.0	3.33	3.34	3.50	3.29
$\gamma$ 58.0	3.26	3.32	3.21	2.80
$\gamma$ 59.0	3.30	3.23	3.06	2.70
$\gamma$ 60.0	3.27	2.90	2.91	2.78
$\gamma$ 61.0	3.15	2.65	2.82	2.68
$\gamma$ 62.0	2.88	2.79	2.68	2.77
$\gamma$ 63.0	2.56	2.59	2.49	2.69
$\gamma$ 64.0	2.18	2.67	2.37	2.35
$\gamma$ 65.0	2.12	2.34	2.12	2.15
$\gamma$ 66.0	2.24	1.97	1.91	2.05
$\gamma$ 67.0	1.90	1.76	1.68	1.83
$\gamma$ 68.0	1.78	1.59	1.68	1.79
$\gamma$ 69.0	1.74	1.48	1.88	1.70
$\gamma$ 70.0	1.63	1.56	1.80	1.55
$\gamma$ 71.0	1.77	1.69	1.65	1.63
$\gamma$ 72.0	1.83	1.79	1.57	1.89
$\gamma$ 73.0	1.77	1.52	1.56	1.75
$\gamma$ 74.0	1.68	1.58	1.67	1.79
$\gamma$ 75.0	1.55	1.63	1.64	1.81
$\gamma$ 76.0	1.59	1.72	1.51	1.80
$\gamma$ 77.0	1.69	2.09	1.43	1.87
$\gamma$ 78.0	1.72	1.88	1.61	1.92
$\gamma$ 79.0	1.73	2.08	1.83	2.13
$\gamma$ 80.0	1.70	1.75	1.74	2.04
$\gamma$ 81.0	1.70	1.87	1.82	1.93
$\gamma$ 82.0	1.92	1.78	1.93	1.80
$\gamma$ 83.0	1.92	1.84	1.85	1.87
$\gamma$ 84.0	1.85	2.00	1.83	1.85
$\gamma$ 85.0	1.98	2.02	1.93	1.77
$\gamma$ 86.0	2.03	2.14	1.98	2.03
$\gamma$ 87.0	2.01	2.12	2.18	2.23
$\gamma$ 88.0	2.04	2.26	2.30	1.93
$\gamma$ 89.0	2.09	2.03	2.13	2.12
$\gamma$ 90.0	2.11	2.28	2.23	2.31
$\gamma$ 91.0	2.26	2.40	2.28	2.10
$\gamma$ 92.0	2.27	2.33	2.28	2.24
$\gamma$ 93.0	2.14	2.33	2.30	2.27
$\gamma$ 94.0	2.00	2.54	2.23	2.04
$\gamma$ 95.0	2.08	2.53	2.29	2.30
$\gamma$ 96.0	2.36	2.46	2.48	2.34
$\gamma$ 97.0	2.33	2.52	2.70	2.21
$\gamma$ 98.0	2.25	2.67	2.47	2.17
$\gamma$ 99.0	2.34	2.77	2.32	2.23

---

# IES Indoor Report

Photometric Filename:AW12540 8W 1202C9 3090 ZHT35-36D 200.IES

---

## Candela Tabulation - (Cont.)

V/H	C270.0	C292.5	C315.0	C337.5
$\gamma$ 100.0	2.29	2.60	2.41	2.32
$\gamma$ 101.0	2.38	2.62	2.59	2.54
$\gamma$ 102.0	2.39	2.61	2.45	2.40
$\gamma$ 103.0	2.40	2.66	2.30	2.24
$\gamma$ 104.0	2.43	2.53	2.42	2.55
$\gamma$ 105.0	2.33	2.38	2.52	2.49
$\gamma$ 106.0	2.27	2.55	2.55	2.40
$\gamma$ 107.0	2.42	2.72	2.37	2.49
$\gamma$ 108.0	2.50	2.73	2.38	2.48
$\gamma$ 109.0	2.44	2.85	2.51	2.32
$\gamma$ 110.0	2.51	2.61	2.53	2.45
$\gamma$ 111.0	2.55	2.84	2.61	2.54
$\gamma$ 112.0	2.51	2.88	2.55	2.64
$\gamma$ 113.0	2.58	2.67	2.67	2.64
$\gamma$ 114.0	2.35	2.48	2.72	2.48
$\gamma$ 115.0	2.31	2.66	2.81	2.47
$\gamma$ 116.0	2.41	2.89	2.84	2.61
$\gamma$ 117.0	2.49	2.53	2.88	2.63
$\gamma$ 118.0	2.57	2.74	2.89	2.51
$\gamma$ 119.0	2.46	2.68	2.94	2.45
$\gamma$ 120.0	2.45	2.82	2.87	2.52
$\gamma$ 121.0	2.26	2.62	2.61	2.77
$\gamma$ 122.0	2.27	2.86	2.52	2.64
$\gamma$ 123.0	2.50	2.65	2.50	2.45
$\gamma$ 124.0	2.53	2.54	2.57	2.58
$\gamma$ 125.0	2.60	2.74	2.72	2.61
$\gamma$ 126.0	2.77	2.79	2.80	2.56
$\gamma$ 127.0	2.72	2.79	2.75	2.49
$\gamma$ 128.0	2.65	2.64	2.90	2.45
$\gamma$ 129.0	2.53	2.64	2.89	2.67
$\gamma$ 130.0	2.64	2.56	2.77	2.81
$\gamma$ 131.0	2.59	2.59	2.88	2.91
$\gamma$ 132.0	2.43	2.55	2.82	3.01
$\gamma$ 133.0	2.64	2.69	2.72	2.94
$\gamma$ 134.0	2.73	2.96	2.73	2.88
$\gamma$ 135.0	2.79	2.92	2.77	2.91
$\gamma$ 136.0	2.80	3.04	2.89	3.01
$\gamma$ 137.0	2.93	2.92	2.95	3.10
$\gamma$ 138.0	2.93	2.99	2.95	3.04
$\gamma$ 139.0	2.72	2.89	2.94	3.00
$\gamma$ 140.0	2.70	2.85	2.89	2.99
$\gamma$ 141.0	2.86	2.70	2.94	3.07
$\gamma$ 142.0	3.05	2.85	3.06	2.98
$\gamma$ 143.0	2.95	3.18	3.14	3.03
$\gamma$ 144.0	2.89	2.91	3.28	3.06
$\gamma$ 145.0	3.02	3.22	3.32	3.21
$\gamma$ 146.0	2.96	3.46	3.34	3.16

---

# IES Indoor Report

Photometric Filename:AW12540 8W 1202C9 3090 ZHT35-36D 200.IES

---

## Candela Tabulation - (Cont.)

V/H	C270. 0	C292. 5	C315. 0	C337. 5
γ 147. 0	2. 94	3. 18	3. 15	3. 27
γ 148. 0	3. 08	3. 48	3. 14	3. 32
γ 149. 0	3. 22	3. 35	3. 39	3. 27
γ 150. 0	3. 23	3. 34	3. 32	3. 37
γ 151. 0	3. 38	3. 50	3. 35	3. 53
γ 152. 0	3. 47	3. 60	3. 51	3. 62
γ 153. 0	3. 42	3. 51	3. 68	3. 56
γ 154. 0	3. 34	3. 26	3. 73	3. 57
γ 155. 0	3. 34	3. 28	3. 83	3. 59
γ 156. 0	3. 43	3. 71	3. 93	3. 79
γ 157. 0	3. 65	3. 55	3. 91	3. 89
γ 158. 0	3. 64	3. 76	3. 99	3. 80
γ 159. 0	3. 82	3. 44	4. 10	3. 84
γ 160. 0	3. 87	3. 74	4. 13	3. 98
γ 161. 0	3. 87	3. 65	3. 94	4. 20
γ 162. 0	3. 99	3. 74	3. 96	4. 17
γ 163. 0	4. 00	3. 96	4. 02	4. 33
γ 164. 0	3. 94	3. 85	4. 05	4. 27
γ 165. 0	3. 83	4. 10	4. 02	3. 95
γ 166. 0	3. 83	3. 94	4. 05	3. 96
γ 167. 0	3. 87	4. 28	4. 32	4. 24
γ 168. 0	4. 14	4. 44	4. 49	4. 15
γ 169. 0	4. 18	4. 59	4. 45	4. 26
γ 170. 0	4. 11	4. 49	4. 44	4. 25
γ 171. 0	4. 02	4. 22	4. 56	4. 37
γ 172. 0	4. 10	4. 22	4. 60	4. 03
γ 173. 0	4. 08	4. 15	4. 75	3. 97
γ 174. 0	4. 11	4. 17	4. 58	4. 16
γ 175. 0	4. 19	4. 32	4. 41	4. 40
γ 176. 0	4. 24	4. 26	4. 47	4. 47
γ 177. 0	4. 14	4. 15	4. 55	4. 45
γ 178. 0	4. 27	4. 08	4. 42	4. 49
γ 179. 0	4. 32	4. 24	4. 61	4. 43
γ 180. 0	4. 47	4. 47	4. 47	4. 47

---