

# IES Indoor Report

Photometric Filename:AW12540 10W 1202C9 3090 ZHT35-24D 250.IES

## Indoor Luminaire Photometric Data

### Description Information

Luminaire Name: AW12540	Lum. Catalog: Down Light	Test ID:
Lamp Name: 1202C9	Lamp Catalog: COB	Test Date: 2023/07/16
Manufacture:	Shld. Ang(°):24	Test Machine:GON-2000
Test Lab: Test	Frequency(Hz):50	Lamp CCT(K): 3000 Ra: 90
Lum. Size(W*L*H):0.066m*0.066m*0.000m	Lum. Area(m <sup>2</sup> ):0.003	Lum. W(kg): 0.000
Test System: C, γ	Test Step: C=22.5 γ=1.0	Temp.(°C): 25
		Humidity(%): 50.0

### Character Parameter

Lamp Speciality Parameter		Luminaire Speciality Parameter	
Rated Flux(lm): 597.000	Luminaire Flux(lm): 597.190	Field Angle(10%Imax): 52.7(°)	
Rated Power(W): 10	Luminaire Efficiency: 100.03%	Down Lumens&Percent: 571.851lm 95.76%	
Rated Voltage(V): 220	Luminaire EER(lm/W): 56.233	Up Lumens&Percent: 25.339lm 4.24%	
Tested Power(W): 10.620	Max. Candela(cd): 2022.926	S/MH: C0_a180=0.464 C90_270=0.456	
Lamps' Inside: 1	Max Cand@Ang.(°): C=0.0 γ=1.0	CIE Type: Semi-Direct	
Tested Electrics(V, A, pf):220.7, 0.087, 0.551	Beam Angle(50%Imax): 27.5(°)	ErP Φ use(90°): 546.586lm	
Lamp Size(W*L*H):0.066m*0.066m*0.000m	Left=-13.0°, Right=14.5°	IRF(%): 750.235	

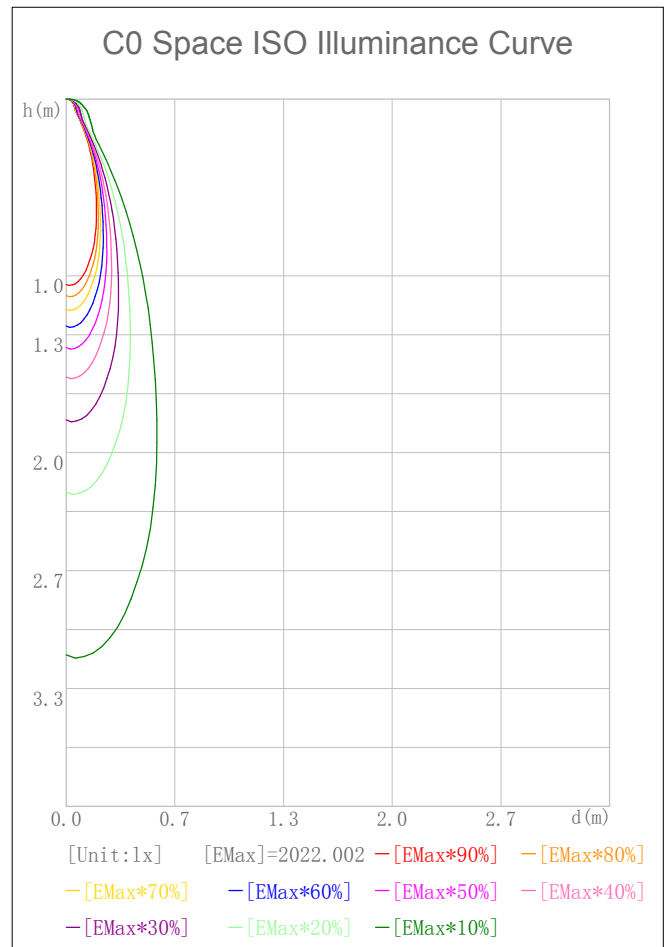
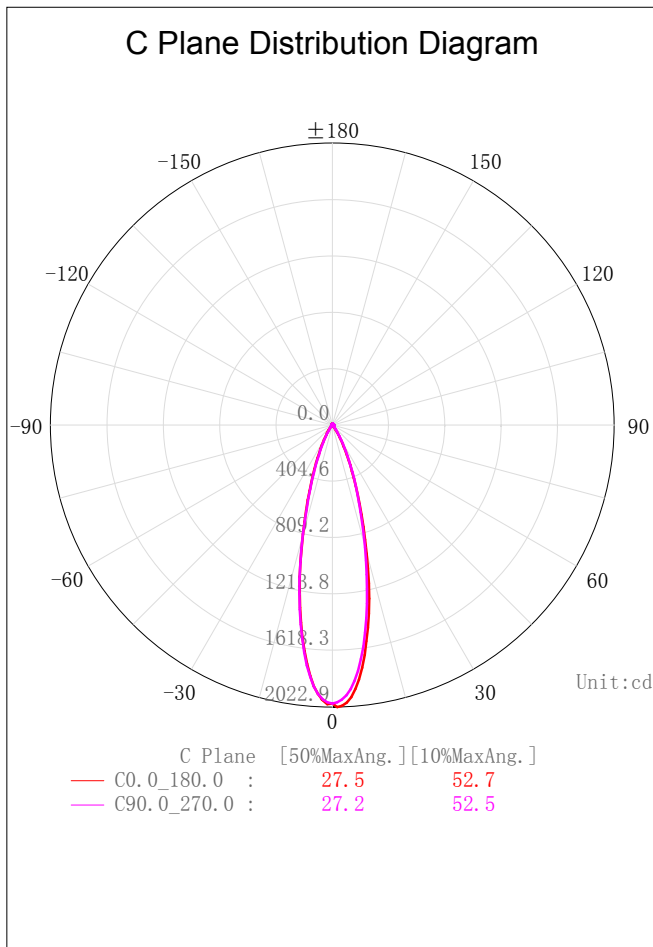

# IES Indoor Report

Photometric Filename:AW12540 10W 1202C9 3090 ZHT35-24D 250.IES

## 2D Plane Light Intensity Distribution Curve

Lum. Name: AW12540	Lum. Catalog: Down Light	Test ID:
Lamp Name: 1202C9	Lamp Catalog: COB	Test Lab: Test
Manufacture:	Test Machine:GON-2000	Test Date: 2023/07/16

C Plane Distribution Diagram

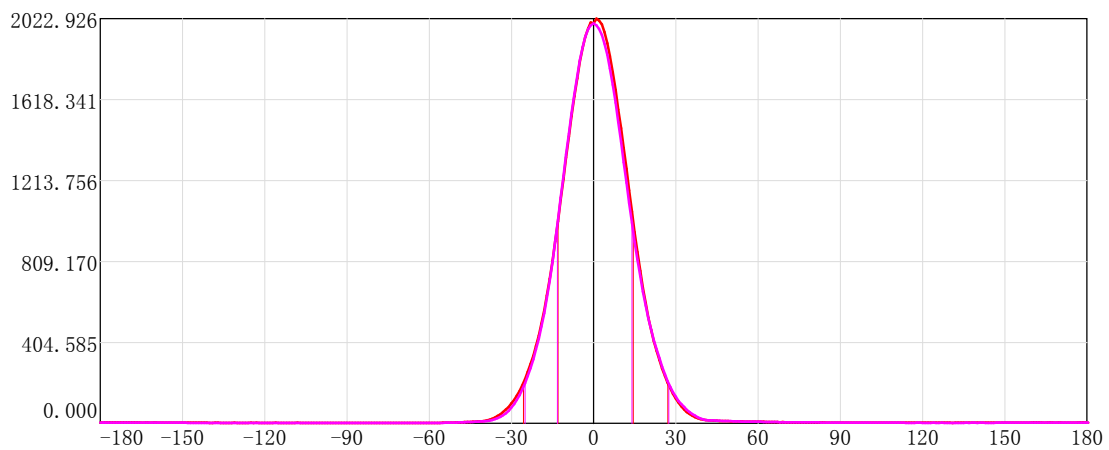
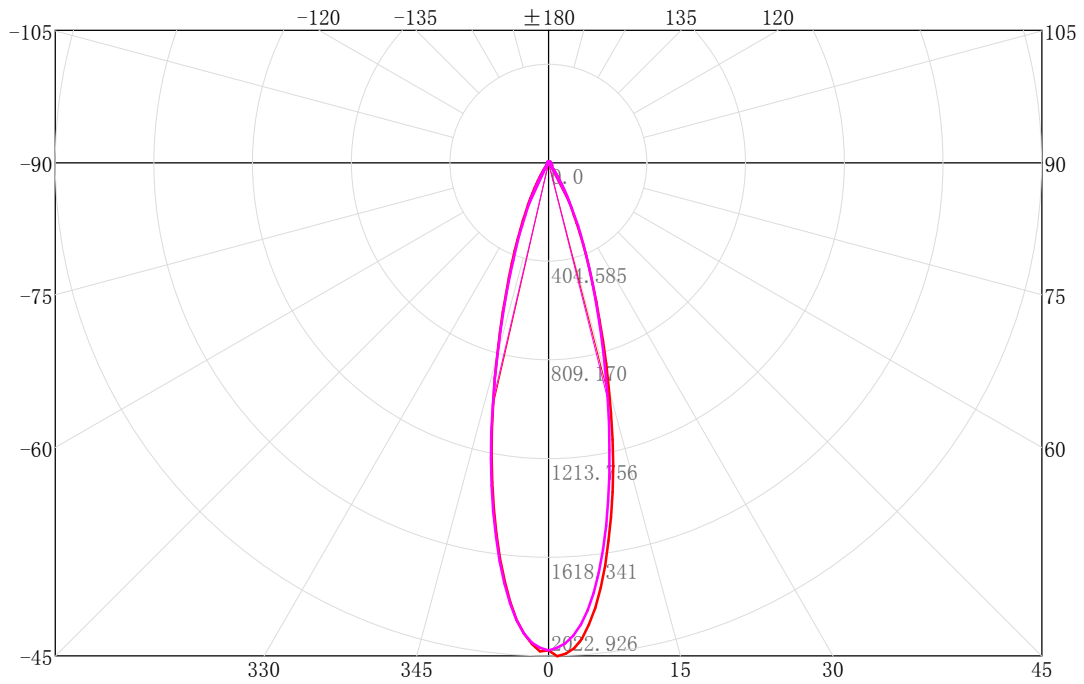

	C Plane	[50%MaxAng.]	[10%MaxAng.]	Unit:cd
—	C0.0_180.0 :	27.5	52.7	
—	C90.0_270.0 :	27.2	52.5	

# IES Indoor Report

Photometric Filename:AW12540 10W 1202C9 3090 ZHT35-24D 250.IES

---

## 3D Light Intensity Distribution Modal

Lum. Name: AW12540	Lum. Catalog: Down Light	Test ID:
Lamp Name: 1202C9	Lamp Catalog: COB	Test Lab: Test
Manufacture:	Test Machine:GON-2000	Test Date: 2023/07/16

## 3D Light Intensity Distribution Modal

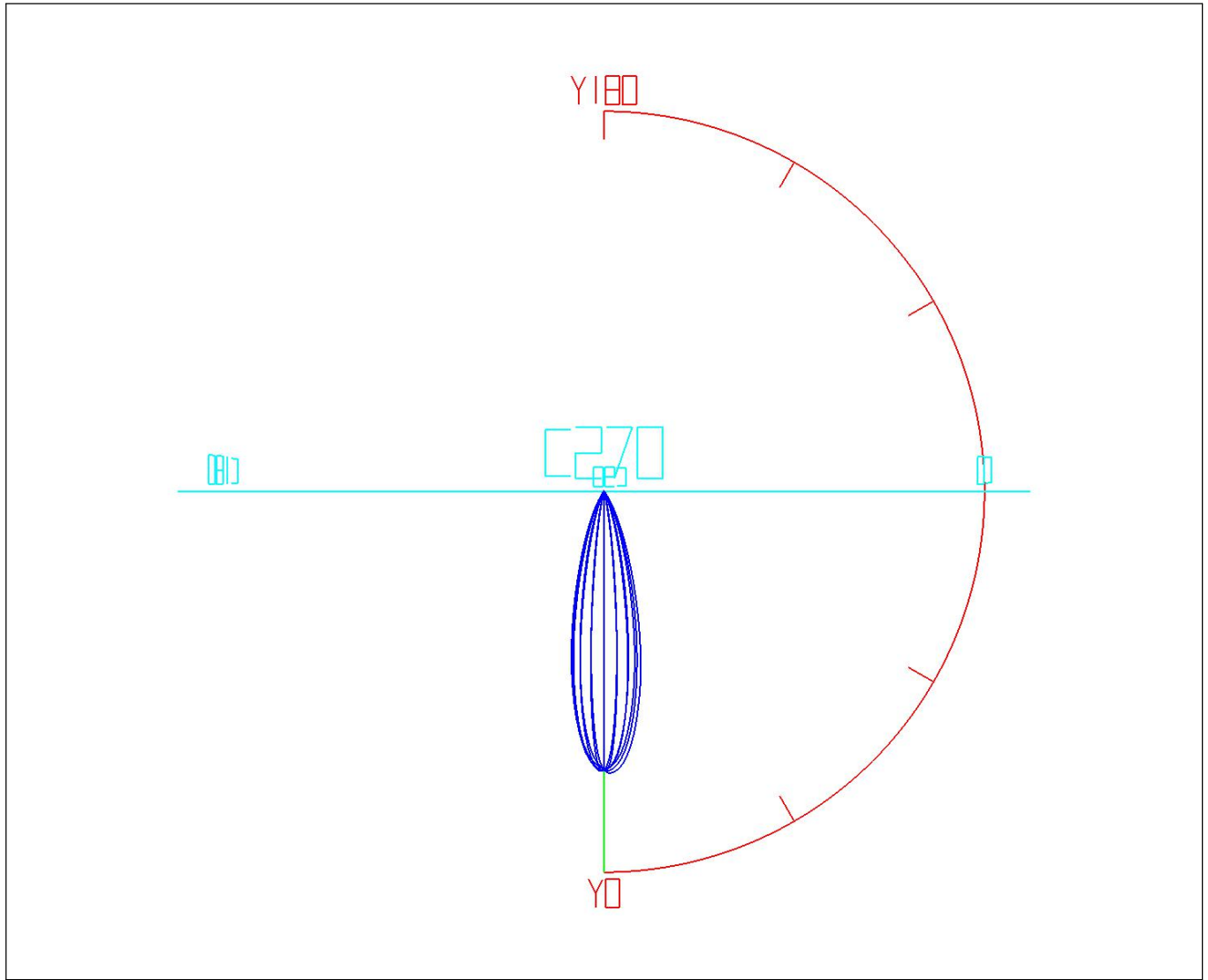

Curves: 3D Model ——— Fixture ——— Vert. HUD ——— Hori. HUD ———  
View Angles: Orient:0 Tilt:0 Roll:0 Spin:0

---

# IES Indoor Report

Photometric Filename:AW12540 10W 1202C9 3090 ZHT35-24D 250.IES

## Zonal Flux Tabulation

Zone (γ)	Zone Flux (lm)	Sums Flux (lm)	Zone%Lamp	Sums%Lamp	Zone (γ)	Zone Flux (lm)	Sums Flux (lm)	Zone%Lamp	Sums%Lamp
0.0-1.0	1.91	1.91	0.32	0.32	47.0-48.0	0.80	549.41	0.13	92.03
1.0-2.0	5.69	7.60	0.95	1.27	48.0-49.0	0.77	550.18	0.13	92.16
2.0-3.0	9.36	16.96	1.57	2.84	49.0-50.0	0.75	550.93	0.12	92.28
3.0-4.0	12.84	29.80	2.15	4.99	50.0-51.0	0.72	551.65	0.12	92.40
4.0-5.0	16.04	45.84	2.69	7.68	51.0-52.0	0.69	552.34	0.12	92.52
5.0-6.0	18.88	64.73	3.16	10.84	52.0-53.0	0.67	553.01	0.11	92.63
6.0-7.0	21.33	86.05	3.57	14.41	53.0-54.0	0.64	553.65	0.11	92.74
7.0-8.0	23.33	109.38	3.91	18.32	54.0-55.0	0.62	554.27	0.10	92.84
8.0-9.0	24.88	134.26	4.17	22.49	55.0-56.0	0.61	554.88	0.10	92.95
9.0-10.0	25.97	160.23	4.35	26.84	56.0-57.0	0.60	555.48	0.10	93.05
10.0-11.0	26.62	186.85	4.46	31.30	57.0-58.0	0.59	556.08	0.10	93.15
11.0-12.0	26.83	213.67	4.49	35.79	58.0-59.0	0.58	556.66	0.10	93.24
12.0-13.0	26.62	240.30	4.46	40.25	59.0-60.0	0.58	557.24	0.10	93.34
13.0-14.0	26.05	266.34	4.36	44.61	60.0-61.0	0.57	557.80	0.10	93.43
14.0-15.0	25.17	291.51	4.22	48.83	61.0-62.0	0.56	558.37	0.09	93.53
15.0-16.0	24.05	315.56	4.03	52.86	62.0-63.0	0.55	558.92	0.09	93.62
16.0-17.0	22.76	338.31	3.81	56.67	63.0-64.0	0.55	559.47	0.09	93.71
17.0-18.0	21.37	359.68	3.58	60.25	64.0-65.0	0.54	560.01	0.09	93.80
18.0-19.0	19.95	379.63	3.34	63.59	65.0-66.0	0.53	560.53	0.09	93.89
19.0-20.0	18.54	398.17	3.11	66.70	66.0-67.0	0.51	561.05	0.09	93.98
20.0-21.0	17.14	415.32	2.87	69.57	67.0-68.0	0.50	561.55	0.08	94.06
21.0-22.0	15.78	431.10	2.64	72.21	68.0-69.0	0.50	562.04	0.08	94.14
22.0-23.0	14.44	445.54	2.42	74.63	69.0-70.0	0.49	562.54	0.08	94.23
23.0-24.0	13.12	458.66	2.20	76.83	70.0-71.0	0.49	563.03	0.08	94.31
24.0-25.0	11.83	470.50	1.98	78.81	71.0-72.0	0.49	563.52	0.08	94.39
25.0-26.0	10.59	481.09	1.77	80.58	72.0-73.0	0.48	564.00	0.08	94.47
26.0-27.0	9.42	490.51	1.58	82.16	73.0-74.0	0.47	564.47	0.08	94.55
27.0-28.0	8.33	498.83	1.39	83.56	74.0-75.0	0.47	564.94	0.08	94.63
28.0-29.0	7.31	506.15	1.22	84.78	75.0-76.0	0.47	565.41	0.08	94.71
29.0-30.0	6.38	512.52	1.07	85.85	76.0-77.0	0.47	565.87	0.08	94.79
30.0-31.0	5.52	518.04	0.92	86.77	77.0-78.0	0.46	566.34	0.08	94.86
31.0-32.0	4.74	522.78	0.79	87.57	78.0-79.0	0.46	566.80	0.08	94.94
32.0-33.0	4.06	526.84	0.68	88.25	79.0-80.0	0.46	567.26	0.08	95.02
33.0-34.0	3.45	530.29	0.58	88.83	80.0-81.0	0.46	567.73	0.08	95.10
34.0-35.0	2.92	533.21	0.49	89.32	81.0-82.0	0.46	568.19	0.08	95.17
35.0-36.0	2.46	535.67	0.41	89.73	82.0-83.0	0.46	568.65	0.08	95.25
36.0-37.0	2.06	537.73	0.34	90.07	83.0-84.0	0.46	569.11	0.08	95.33
37.0-38.0	1.72	539.44	0.29	90.36	84.0-85.0	0.46	569.57	0.08	95.41
38.0-39.0	1.43	540.88	0.24	90.60	85.0-86.0	0.46	570.03	0.08	95.48
39.0-40.0	1.22	542.10	0.20	90.80	86.0-87.0	0.46	570.49	0.08	95.56
40.0-41.0	1.08	543.18	0.18	90.99	87.0-88.0	0.46	570.95	0.08	95.64
41.0-42.0	1.00	544.19	0.17	91.15	88.0-89.0	0.45	571.40	0.08	95.71
42.0-43.0	0.95	545.14	0.16	91.31	89.0-90.0	0.45	571.85	0.08	95.79
43.0-44.0	0.91	546.05	0.15	91.47	90.0-91.0	0.45	572.30	0.08	95.86
44.0-45.0	0.88	546.93	0.15	91.61	91.0-92.0	0.45	572.75	0.08	95.94
45.0-46.0	0.85	547.78	0.14	91.76	92.0-93.0	0.45	573.20	0.08	96.01
46.0-47.0	0.83	548.61	0.14	91.89	93.0-94.0	0.45	573.65	0.07	96.09

# IES Indoor Report

Photometric Filename:AW12540 10W 1202C9 3090 ZHT35-24D 250.IES

## Zonal Flux Tabulation - (Cont.)

Zone (γ)	Zone Flux (lm)	Sums Flux (lm)	Zone%Lamp	Sums%Lamp	Zone (γ)	Zone Flux (lm)	Sums Flux (lm)	Zone%Lamp	Sums%Lamp
94.0-95.0	0.44	574.09	0.07	96.16	141.0-142.0	0.27	591.05	0.05	99.00
95.0-96.0	0.44	574.53	0.07	96.24	142.0-143.0	0.27	591.31	0.04	99.05
96.0-97.0	0.44	574.97	0.07	96.31	143.0-144.0	0.26	591.57	0.04	99.09
97.0-98.0	0.44	575.40	0.07	96.38	144.0-145.0	0.25	591.82	0.04	99.13
98.0-99.0	0.43	575.83	0.07	96.45	145.0-146.0	0.25	592.08	0.04	99.18
99.0-100.0	0.43	576.27	0.07	96.53	146.0-147.0	0.25	592.33	0.04	99.22
100.0-101.0	0.43	576.69	0.07	96.60	147.0-148.0	0.25	592.57	0.04	99.26
101.0-102.0	0.42	577.12	0.07	96.67	148.0-149.0	0.24	592.81	0.04	99.30
102.0-103.0	0.42	577.54	0.07	96.74	149.0-150.0	0.24	593.05	0.04	99.34
103.0-104.0	0.42	577.96	0.07	96.81	150.0-151.0	0.24	593.29	0.04	99.38
104.0-105.0	0.42	578.38	0.07	96.88	151.0-152.0	0.23	593.52	0.04	99.42
105.0-106.0	0.42	578.79	0.07	96.95	152.0-153.0	0.23	593.75	0.04	99.46
106.0-107.0	0.41	579.21	0.07	97.02	153.0-154.0	0.22	593.98	0.04	99.49
107.0-108.0	0.41	579.61	0.07	97.09	154.0-155.0	0.22	594.20	0.04	99.53
108.0-109.0	0.40	580.01	0.07	97.15	155.0-156.0	0.21	594.41	0.04	99.57
109.0-110.0	0.40	580.41	0.07	97.22	156.0-157.0	0.21	594.62	0.04	99.60
110.0-111.0	0.39	580.80	0.07	97.29	157.0-158.0	0.20	594.83	0.03	99.64
111.0-112.0	0.39	581.19	0.07	97.35	158.0-159.0	0.20	595.03	0.03	99.67
112.0-113.0	0.39	581.58	0.06	97.42	159.0-160.0	0.19	595.22	0.03	99.70
113.0-114.0	0.38	581.96	0.06	97.48	160.0-161.0	0.19	595.40	0.03	99.73
114.0-115.0	0.38	582.34	0.06	97.54	161.0-162.0	0.18	595.58	0.03	99.76
115.0-116.0	0.38	582.72	0.06	97.61	162.0-163.0	0.17	595.75	0.03	99.79
116.0-117.0	0.37	583.09	0.06	97.67	163.0-164.0	0.16	595.91	0.03	99.82
117.0-118.0	0.37	583.46	0.06	97.73	164.0-165.0	0.15	596.06	0.03	99.84
118.0-119.0	0.36	583.82	0.06	97.79	165.0-166.0	0.14	596.21	0.02	99.87
119.0-120.0	0.36	584.18	0.06	97.85	166.0-167.0	0.13	596.34	0.02	99.89
120.0-121.0	0.36	584.54	0.06	97.91	167.0-168.0	0.12	596.46	0.02	99.91
121.0-122.0	0.35	584.90	0.06	97.97	168.0-169.0	0.11	596.58	0.02	99.93
122.0-123.0	0.35	585.25	0.06	98.03	169.0-170.0	0.10	596.68	0.02	99.95
123.0-124.0	0.34	585.59	0.06	98.09	170.0-171.0	0.10	596.78	0.02	99.96
124.0-125.0	0.34	585.93	0.06	98.15	171.0-172.0	0.09	596.87	0.01	99.98
125.0-126.0	0.33	586.26	0.06	98.20	172.0-173.0	0.08	596.94	0.01	99.99
126.0-127.0	0.33	586.59	0.05	98.26	173.0-174.0	0.07	597.01	0.01	100.00
127.0-128.0	0.32	586.92	0.05	98.31	174.0-175.0	0.06	597.06	0.01	100.01
128.0-129.0	0.32	587.24	0.05	98.36	175.0-176.0	0.05	597.11	0.01	100.02
129.0-130.0	0.32	587.56	0.05	98.42	176.0-177.0	0.04	597.14	0.01	100.02
130.0-131.0	0.32	587.88	0.05	98.47	177.0-178.0	0.03	597.17	0.00	100.03
131.0-132.0	0.31	588.18	0.05	98.52	178.0-179.0	0.02	597.18	0.00	100.03
132.0-133.0	0.30	588.49	0.05	98.57	179.0-180.0	0.01	597.19	0.00	100.03
133.0-134.0	0.30	588.79	0.05	98.62					
134.0-135.0	0.30	589.08	0.05	98.67					
135.0-136.0	0.29	589.37	0.05	98.72					
136.0-137.0	0.29	589.66	0.05	98.77					
137.0-138.0	0.29	589.95	0.05	98.82					
138.0-139.0	0.28	590.23	0.05	98.87					
139.0-140.0	0.27	590.50	0.05	98.91					
140.0-141.0	0.27	590.77	0.05	98.96					

# IES Indoor Report

Photometric Filename:AW12540 10W 1202C9 3090 ZHT35-24D 250.IES

## Rectangle ISO Lighting Intensity Diagram

Lum. Name: AW12540	Lum. Catalog: Down Light	Test ID:
Lamp Name: 1202C9	Lamp Catalog: COB	Test Lab: Test
Manufacture:	Test Machine: GON-2000	Test Date: 2023/07/16

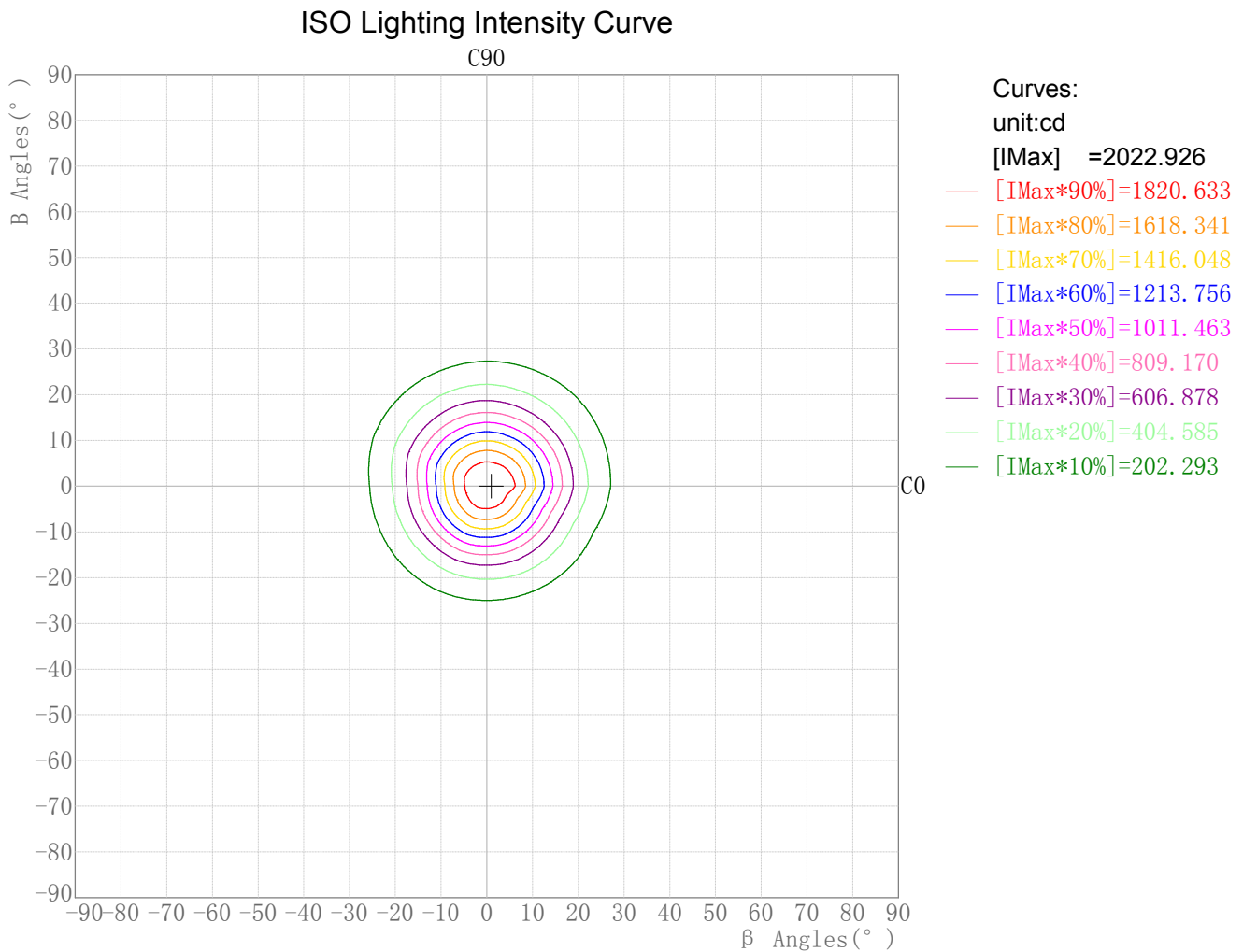

Maximum Light Intensity(cd): 2022.93

Maximum Cand.@Angle: H=1.0°,V=0.0°

# IES Indoor Report

Photometric Filename:AW12540 10W 1202C9 3090 ZHT35-24D 250.IES

## Round ISO Lighting Intensity Diagram

Lum. Name: AW12540	Lum. Catalog: Down Light	Test ID:
Lamp Name: 1202C9	Lamp Catalog: COB	Test Lab: Test
Manufacture:	Test Machine:GON-2000	Test Date: 2023/07/16

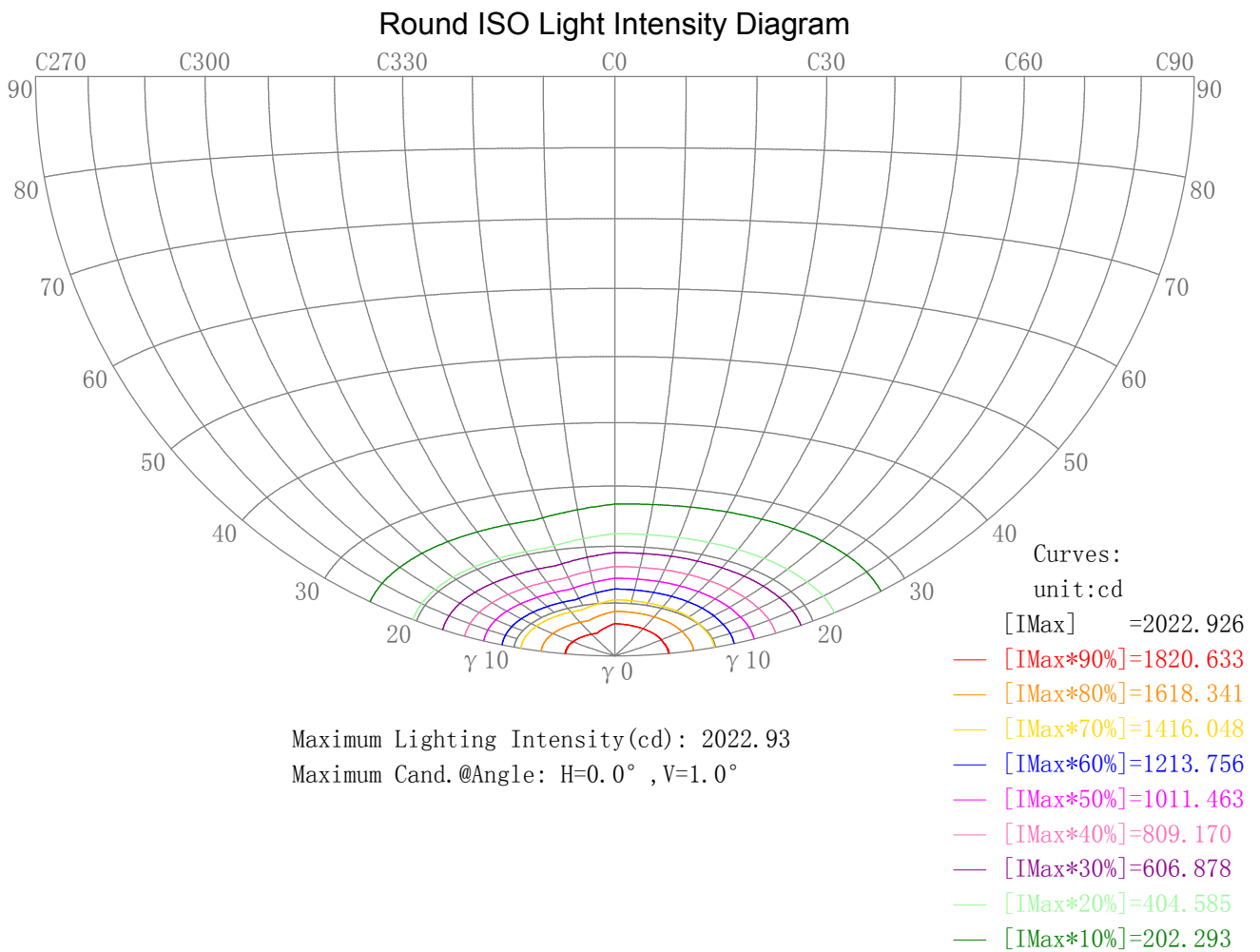

# IES Indoor Report

Photometric Filename:AW12540 10W 1202C9 3090 ZHT35-24D 250.IES

## Plane ISO-Illuminance Diagram

Lum. Name: AW12540	Lum. Catalog: Down Light	Test ID:
Lamp Name: 1202C9	Lamp Catalog: COB	Test Lab: Test
Manufacture:	Test Machine: GON-2000	Test Date: 2023/07/16

Plane ISO-Illuminance Curve

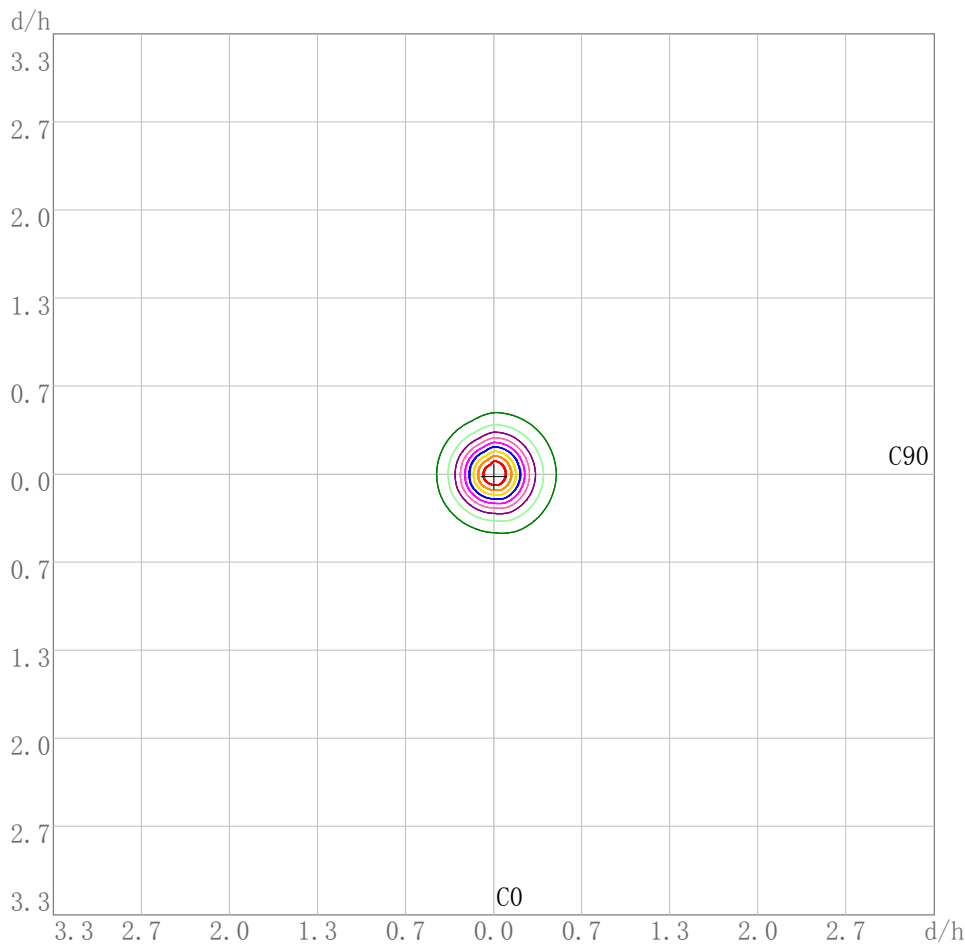

- Curves:  
unit:lx
- [EMax] =224.667
  - [EMax\*90%]=202.200
  - [EMax\*80%]=179.733
  - [EMax\*70%]=157.267
  - [EMax\*60%]=134.800
  - [EMax\*50%]=112.333
  - [EMax\*40%]=89.867
  - [EMax\*30%]=67.400
  - [EMax\*20%]=44.933
  - [EMax\*10%]=22.467

Working Plane Luminaire Mounting Height(m): 3.00  
 Working Plane Maximum Illuminance(lx): 224.67  
 Working Plane Maximum Illuminance Position(d/h):H0.0 V0.0



# IES Indoor Report

Photometric Filename:AW12540 10W 1202C9 3090 ZHT35-24D 250.IES

---

## 3D Plane ISO Illuminance Diagram

Lum. Name: AW12540	Lum. Catalog: Down Light	Test ID:
Lamp Name: 1202C9	Lamp Catalog: COB	Test Lab: Test
Manufacture:	Test Machine: GON-2000	Test Date: 2023/07/16

### 3D Plane Illuminance Modal

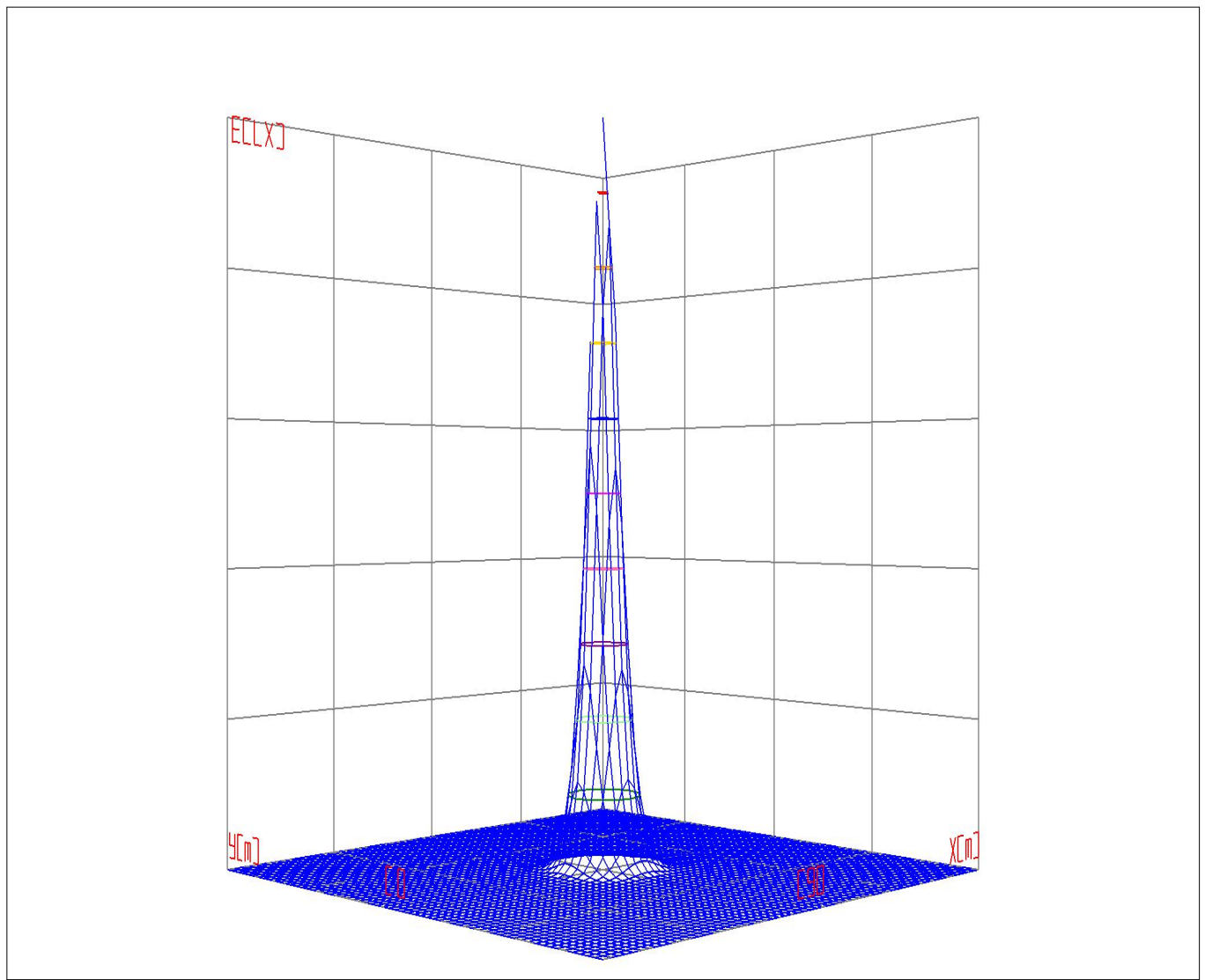

Curves: 3D Model — 90% — 80% — 70% — 60% — 50% — 40% — 30% — 20% — 10% —  
View Angles(deg): 0 Height(m): 3.0 Distance(m): 10.0

---

# IES Indoor Report

Photometric Filename:AW12540 10W 1202C9 3090 ZHT35-24D 250.IES

---

## Space ISO Illuminance Diagram

Lum. Name: AW12540	Lum. Catalog: Down Light	Test ID:
Lamp Name: 1202C9	Lamp Catalog: COB	Test Lab: Test
Manufacture:	Test Machine: GON-2000	Test Date: 2023/07/16

### Space ISO Illuminance Curve

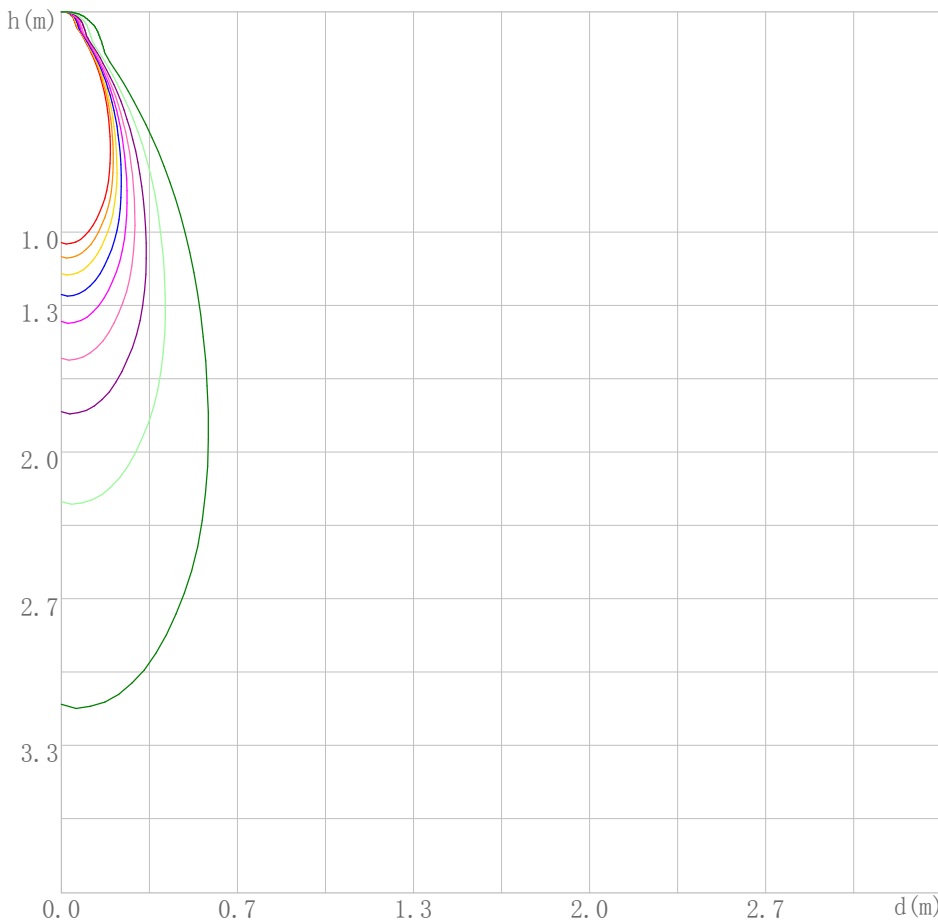

- Curves:  
[Unit: lx]  
[EMax] =2022.002
- [EMax\*90%]=1819.802
  - [EMax\*80%]=1617.601
  - [EMax\*70%]=1415.401
  - [EMax\*60%]=1213.201
  - [EMax\*50%]=1011.001
  - [EMax\*40%]=808.801
  - [EMax\*30%]=606.601
  - [EMax\*20%]=404.400
  - [EMax\*10%]=202.200

Space Plane Maximum Illuminance and @Angle:2022.00lx,1.0deg  
Plane Maximum Lighting Intensity and @Angle:2022.926cd,0deg

---

# IES Indoor Report

Photometric Filename:AW12540 10W 1202C9 3090 ZHT35-24D 250.IES

## Illuminance-Distance Diagram

Lum. Name: AW12540	Lum. Catalog: Down Light	Test ID:
Lamp Name: 1202C9	Lamp Catalog: COB	Test Lab: Test
Manufacture:	Test Machine:GON-2000	Test Date: 2023/07/16

Illuminance-Distance Curve

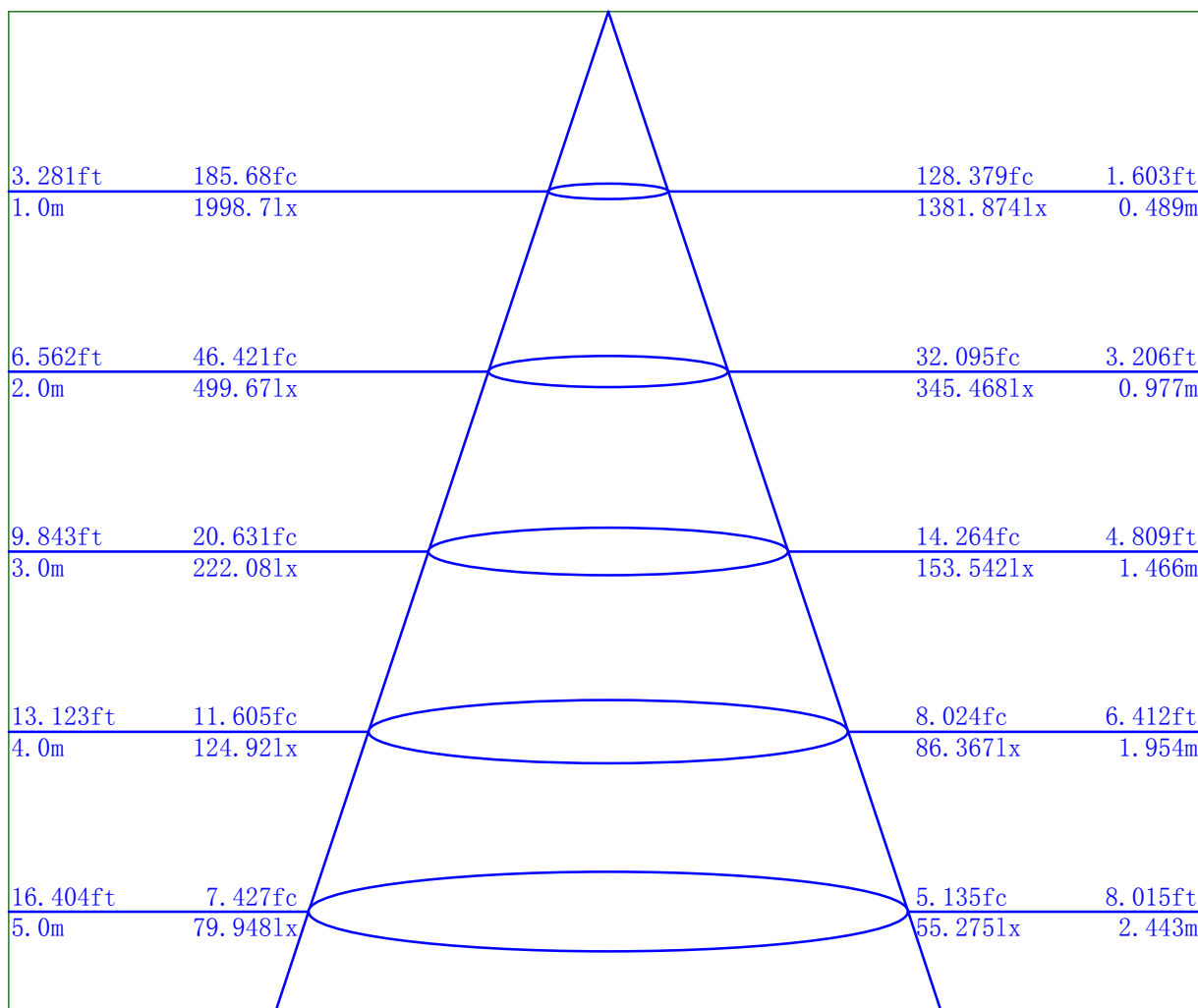

Height

Center E

Average E

Diameter

Beam Angle:27.5

# IES Indoor Report

Photometric Filename:AW12540 10W 1202C9 3090 ZHT35-24D 250.IES

## Indoor Luminance Limiting Curves

Lum. Name: AW12540	Lum. Catalog: Down Light	Test ID:
Lamp Name: 1202C9	Lamp Catalog: COB	Test Lab: Test
Manufacture:	Test Machine:GON-2000	Test Date: 2023/07/16

Glare Grade Table

GI	Quality	Using Illuminance							
		a	b	c	d	e	f	g	h
1.15	A	2000	1000	500	<=300				
1.5	B		2000	1000	500	<=300			
1.85	C			2000	1000	500	<=300		
2.2	D				2000	1000	500	<=300	
2.55	E	a				2000	1000	500	<=300
			b	c	d	e	f	g	h

Luminance Table

Gama(deg)	45	50	55	60	65	70	75	80	85
C0	5913	5290	5265	5368	5613	5973	7640	10527	18060
C90	6116	5561	5043	5213	5661	6097	7080	10278	17892

Luminance Limiting Curve

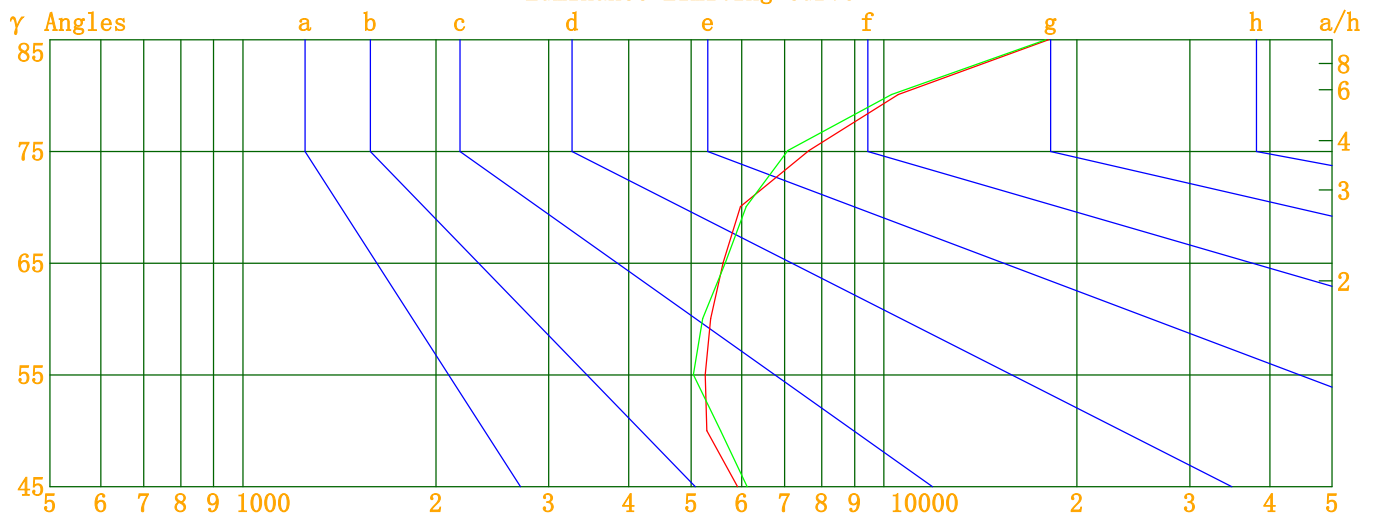

Luminous Size: Length(m)=-0.066 Width(m)=-0.066 Height(m)=0.000 Area(m^2)=0.003421  
 Luminous Type: Without Luminous Side  
 Luminous Curves: C0-C180 Color: — C90-C270 Color: —

# IES Indoor Report

Photometric Filename:AW12540 10W 1202C9 3090 ZHT35-24D 250.IES

## Indoor Budgetary Estimate Table

Lum. Name: AW12540	Lum. Catalog: Down Light	Test ID:
Lamp Name: 1202C9	Lamp Catalog: COB	Test Lab: Test
Manufacture:	Test Machine: GON-2000	Test Date: 2023/07/16

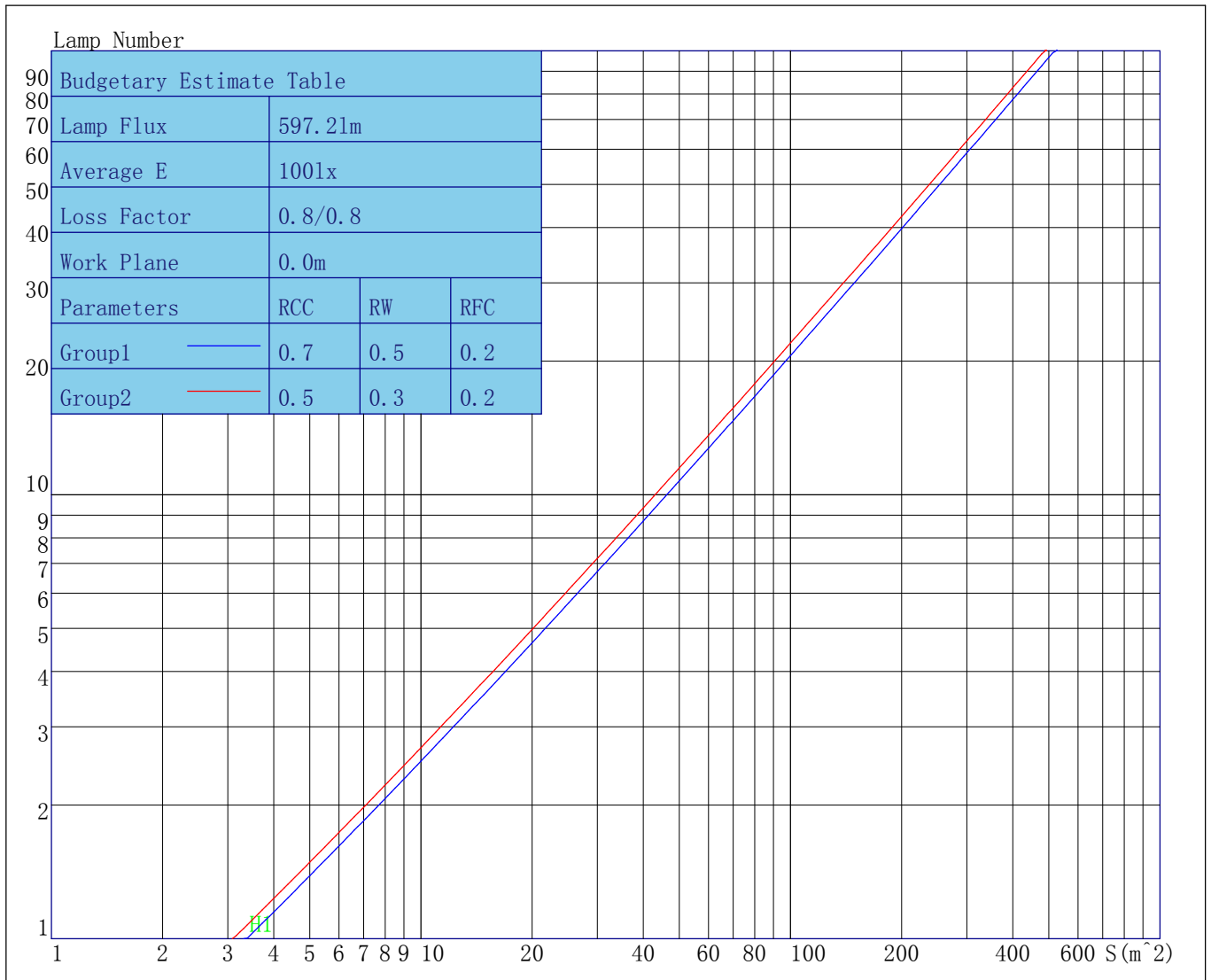

Parameters1: Rhocc = 0.7 Rhow = 0.5 Rhofc = 0.2 LLF = 0.8  
 Parameters2: Rhocc = 0.5 Rhow = 0.3 Rhofc = 0.2 LLF = 0.8  
 Average Illuminance(lx): 100 Cavity Height: H1(m) = 2

# IES Indoor Report

Photometric Filename:AW12540 10W 1202C9 3090 ZHT35-24D 250.IES

## Indoor Coefficient of Utilization Table

Lum. Name: AW12540	Lum. Catalog: Down Light	Test ID:
Lamp Name: 1202C9	Lamp Catalog: COB	Test Lab: Test
Manufacture:	Test Machine:GON-2000	Test Date: 2023/07/16

Coefficients of Utilization - Zonal Cavity Method																		
Coef.	Effective Floor Cavity Reflectance RFC=0.20																	
RhoCC (%)	80				70				50			30			10			0
RhoW (%)	70	50	30	10	70	50	30	10	50	30	10	50	30	10	50	30	10	0
RCR	Coefficient of Utilization(%)																	
0	118	118	118	118	115	115	115	115	109	109	109	103	103	103	98	98	98	96
1	113	110	108	106	110	108	106	104	103	101	100	99	97	96	95	94	93	91
2	108	104	101	98	106	102	99	96	98	96	93	95	93	91	91	90	88	87
3	104	99	94	91	102	97	93	90	94	91	88	91	88	86	88	86	84	83
4	100	94	89	86	98	93	88	85	90	86	84	88	85	82	85	83	81	79
5	97	90	85	81	95	89	84	81	86	83	80	84	81	79	83	80	78	76
6	93	86	81	78	92	85	80	77	83	79	76	81	78	76	80	77	75	73
7	90	83	78	74	89	82	77	74	80	76	73	79	75	73	77	74	72	71
8	87	79	75	71	86	79	74	71	77	73	71	76	73	70	75	72	70	68
9	84	77	72	69	83	76	72	69	75	71	68	74	70	68	73	70	67	66
10	82	74	69	66	81	74	69	66	72	69	66	72	68	65	71	67	65	64

# IES Indoor Report

Photometric Filename:AW12540 10W 1202C9 3090 ZHT35-24D 250.IES

## Unified Glare Rating Table

Lum. Name: AW12540	Lum. Catalog: Down Light	Test ID:
Lamp Name: 1202C9	Lamp Catalog: COB	Test Lab: Test
Manufacture:	Test Machine:GON-2000	Test Date: 2023/07/16

## Unified Glare Rating Table

Ceiling RCC	0.70	0.70	0.50	0.50	0.30	0.70	0.70	0.50	0.50	0.30	
Wall RW	0.50	0.30	0.50	0.30	0.30	0.50	0.30	0.50	0.30	0.30	
Floor RFC	0.20	0.20	0.20	0.20	0.20	0.20	0.20	0.20	0.20	0.20	
Room Size	Vewed crosswise					Vewed endwise					
X=2H	Y=2H	11.3	12.2	11.7	12.6	13.0	12.6	13.5	13.0	13.9	14.3
	Y=3H	12.8	13.6	13.2	14.0	14.5	13.9	14.7	14.4	15.2	15.6
	Y=4H	13.8	14.6	14.3	15.0	15.5	14.8	15.6	15.3	16.0	16.5
	Y=6H	15.2	15.9	15.7	16.4	16.9	16.0	16.7	16.5	17.2	17.7
	Y=8H	16.1	16.8	16.6	17.2	17.8	16.7	17.4	17.3	17.9	18.4
	Y=12H	17.1	17.8	17.6	18.2	18.8	17.6	18.2	18.1	18.7	19.2
X=4H	Y=2H	11.5	12.3	12.0	12.7	13.2	13.0	13.7	13.4	14.2	14.6
	Y=3H	13.3	13.9	13.8	14.4	14.9	14.6	15.2	15.1	15.7	16.2
	Y=4H	14.5	15.0	15.0	15.6	16.1	15.7	16.3	16.3	16.8	17.4
	Y=6H	16.1	16.6	16.7	17.2	17.7	17.2	17.7	17.7	18.2	18.8
	Y=8H	17.2	17.6	17.7	18.2	18.7	18.0	18.5	18.6	19.0	19.6
	Y=12H	18.4	18.8	19.0	19.3	19.9	19.1	19.5	19.6	20.0	20.6
X=8H	Y=4H	14.9	15.3	15.4	15.8	16.4	16.2	16.6	16.7	17.2	17.7
	Y=6H	16.7	17.1	17.3	17.7	18.3	17.9	18.3	18.5	18.9	19.5
	Y=8H	17.9	18.3	18.5	18.9	19.5	19.0	19.3	19.6	19.9	20.5
	Y=12H	19.4	19.7	20.0	20.3	20.9	20.3	20.5	20.9	21.1	21.8
X=12H	Y=4H	14.9	15.3	15.5	15.9	16.5	16.3	16.7	16.9	17.3	17.8
	Y=6H	16.9	17.3	17.5	17.8	18.4	18.2	18.5	18.8	19.0	19.7
	Y=8H	18.2	18.5	18.8	19.1	19.8	19.3	19.6	19.9	20.2	20.8
Variations with the objverer position at spacings											
S=1.0H	0.1/-0.1					0.1/-0.1					
S=1.5H	0.1/-0.1					0.1/-0.1					
S=2.0H	0.2/-0.4					0.1/-0.1					
Reduced UGR Table:											
Nordic Standard Table:	BKO					BKO					
Correction Value	4.9					4.7					

o the CIE Pub. 117, data has been corrected, refers to the lamp's lumens 8.2flm.

# IES Indoor Report

Photometric Filename:AW12540 10W 1202C9 3090 ZHT35-24D 250.IES

## Candela Tabulation

V/H	C0.0	C22.5	C45.0	C67.5	C90.0	C112.5	C135.0	C157.5	C180.0	C202.5	C225.0	C247.5
$\gamma$ 0.0	1998.69	1998.69	1998.69	1998.69	1998.69	1998.69	1998.69	1998.69	1998.69	1998.69	1998.69	1998.69
$\gamma$ 1.0	2022.93	2009.83	2001.20	1995.44	1989.09	1985.22	1980.10	1978.02	2003.17	1993.81	1991.83	1993.57
$\gamma$ 2.0	2014.04	1998.89	1986.57	1975.56	1971.80	1967.74	1962.63	1960.84	1973.62	1966.34	1968.12	1974.30
$\gamma$ 3.0	1993.60	1976.06	1960.13	1945.51	1941.28	1937.48	1933.51	1932.55	1931.88	1926.47	1932.47	1942.04
$\gamma$ 4.0	1956.24	1938.44	1921.61	1904.12	1897.89	1892.59	1891.45	1892.00	1877.97	1872.10	1878.63	1891.28
$\gamma$ 5.0	1900.43	1884.28	1866.72	1845.56	1842.44	1836.26	1836.48	1837.63	1806.37	1801.65	1810.68	1825.53
$\gamma$ 6.0	1835.30	1818.59	1798.67	1774.55	1773.05	1768.51	1769.17	1768.07	1723.45	1721.13	1732.52	1749.06
$\gamma$ 7.0	1754.52	1741.31	1721.46	1693.82	1691.76	1688.69	1690.39	1687.33	1633.89	1632.15	1644.04	1661.52
$\gamma$ 8.0	1665.83	1653.88	1633.45	1603.97	1602.35	1600.50	1603.12	1599.54	1534.98	1535.58	1548.20	1565.84
$\gamma$ 9.0	1569.05	1559.12	1538.34	1507.60	1506.38	1505.63	1509.23	1504.91	1433.99	1434.57	1446.35	1465.62
$\gamma$ 10.0	1475.47	1460.13	1438.65	1407.99	1406.56	1405.60	1409.88	1404.77	1329.15	1330.06	1340.90	1361.27
$\gamma$ 11.0	1376.73	1359.08	1335.83	1305.44	1304.79	1303.60	1307.35	1302.35	1222.03	1223.80	1232.84	1254.79
$\gamma$ 12.0	1272.32	1255.75	1231.53	1201.93	1202.37	1200.98	1203.46	1199.68	1116.15	1116.88	1123.89	1146.16
$\gamma$ 13.0	1165.35	1152.71	1128.27	1100.69	1101.77	1099.23	1101.07	1097.54	1011.27	1010.85	1015.88	1037.88
$\gamma$ 14.0	1058.23	1051.19	1025.48	1002.18	1003.07	999.92	1001.37	997.04	909.70	908.16	910.39	930.85
$\gamma$ 15.0	956.04	951.52	926.31	905.53	908.43	906.07	905.22	902.56	813.19	809.79	810.01	828.22
$\gamma$ 16.0	856.49	855.58	831.95	815.07	819.41	816.97	814.44	811.00	723.33	717.24	715.49	730.91
$\gamma$ 17.0	763.19	763.76	742.54	728.26	735.47	733.22	729.49	725.70	640.08	631.79	629.68	642.56
$\gamma$ 18.0	677.33	677.98	659.80	649.41	658.12	656.86	651.46	646.46	565.48	554.30	551.41	561.48
$\gamma$ 19.0	600.89	600.12	584.47	577.09	588.41	587.21	581.30	574.53	498.33	484.98	482.53	490.83
$\gamma$ 20.0	530.07	529.43	518.08	513.62	525.61	524.55	517.82	508.63	439.66	423.40	420.41	427.27
$\gamma$ 21.0	467.67	466.62	458.81	456.09	468.84	466.20	460.35	450.63	386.97	368.41	365.70	372.49
$\gamma$ 22.0	412.15	411.44	406.65	405.51	417.49	413.68	407.96	397.65	339.38	320.27	317.49	322.91
$\gamma$ 23.0	362.45	361.94	359.64	359.74	370.38	364.62	359.34	350.20	296.66	277.42	274.32	278.99
$\gamma$ 24.0	316.19	317.06	317.17	317.33	326.34	319.13	314.39	306.29	257.10	239.39	235.49	239.03
$\gamma$ 25.0	274.42	276.88	277.58	277.48	284.60	277.09	273.02	266.49	221.59	206.13	201.87	204.19
$\gamma$ 26.0	237.52	241.54	242.50	241.72	246.19	238.65	234.97	229.94	190.49	176.95	172.58	172.91
$\gamma$ 27.0	204.52	210.02	211.47	209.69	212.31	204.67	201.42	198.36	163.73	151.47	146.47	145.80
$\gamma$ 28.0	175.55	181.54	183.43	181.29	182.47	175.88	172.94	170.49	139.89	129.15	123.66	122.14
$\gamma$ 29.0	148.98	155.68	157.60	156.07	156.31	150.67	148.34	146.30	118.80	109.14	103.93	101.86
$\gamma$ 30.0	125.46	132.32	134.58	133.56	133.80	128.82	127.09	125.10	100.22	91.67	86.63	84.01
$\gamma$ 31.0	104.75	111.37	113.87	113.43	114.31	109.82	108.83	106.64	83.86	76.11	71.29	68.70
$\gamma$ 32.0	86.62	93.00	95.43	95.65	97.33	93.84	93.28	90.92	69.73	62.68	58.22	55.83
$\gamma$ 33.0	71.13	76.80	79.37	80.26	82.43	79.83	79.58	76.76	57.14	51.35	47.37	45.68
$\gamma$ 34.0	58.23	62.88	65.56	66.70	69.18	67.14	67.30	64.87	47.03	41.81	38.59	37.02
$\gamma$ 35.0	47.97	51.49	53.94	55.09	57.78	56.31	56.61	53.83	38.24	33.86	31.02	29.86
$\gamma$ 36.0	39.79	42.22	44.11	45.40	47.89	46.51	47.27	44.76	30.78	27.13	24.87	24.08
$\gamma$ 37.0	32.73	34.49	35.82	37.06	39.43	38.63	39.31	37.12	24.44	21.71	19.89	19.31
$\gamma$ 38.0	26.53	27.94	28.80	29.89	32.13	31.91	32.38	30.45	18.95	17.37	15.93	15.57
$\gamma$ 39.0	22.02	22.81	23.24	23.89	25.73	25.73	26.42	24.96	15.62	14.08	13.26	13.24
$\gamma$ 40.0	19.32	19.31	19.46	20.15	20.92	21.31	22.02	21.00	12.89	11.95	11.40	11.47
$\gamma$ 41.0	17.16	17.31	17.14	17.71	18.14	18.59	19.34	18.37	11.59	10.68	10.34	10.42
$\gamma$ 42.0	16.08	16.14	15.63	16.28	16.76	16.98	17.81	16.91	10.71	9.76	9.64	9.64
$\gamma$ 43.0	15.62	15.30	14.96	15.47	15.89	16.14	16.82	16.11	9.81	9.10	8.96	8.99
$\gamma$ 44.0	14.66	14.55	14.34	14.74	15.27	15.18	15.91	15.10	9.37	8.52	8.57	8.34
$\gamma$ 45.0	14.30	13.86	13.69	14.30	14.80	14.62	15.07	14.62	8.55	8.08	7.97	7.66
$\gamma$ 46.0	13.51	13.44	13.35	13.55	14.23	13.82	14.60	14.00	8.10	7.88	7.38	7.03



# IES Indoor Report

Photometric Filename:AW12540 10W 1202C9 3090 ZHT35-24D 250.IES

## Candela Tabulation - (Cont.)

V/H	C0.0	C22.5	C45.0	C67.5	C90.0	C112.5	C135.0	C157.5	C180.0	C202.5	C225.0	C247.5
γ 47.0	13.20	13.04	13.06	13.21	13.55	13.58	14.25	13.45	7.66	7.18	6.78	6.52
γ 48.0	12.65	12.47	12.71	12.88	13.10	13.09	13.72	13.30	6.96	6.51	5.86	6.05
γ 49.0	12.40	12.01	12.04	12.23	12.72	12.87	13.04	12.60	6.73	6.05	5.38	5.49
γ 50.0	11.63	11.57	11.55	11.89	12.23	12.24	12.56	12.13	6.14	5.37	5.00	5.11
γ 51.0	11.41	11.14	11.21	11.18	11.85	11.52	12.16	11.81	5.50	4.87	4.69	4.51
γ 52.0	11.19	10.77	10.73	11.18	11.49	11.13	11.56	11.15	5.09	4.66	4.10	4.17
γ 53.0	10.57	10.44	10.49	10.47	10.98	10.52	10.99	10.73	4.78	4.35	3.83	4.02
γ 54.0	10.49	10.22	10.13	10.16	10.36	9.98	10.40	10.32	4.46	3.87	3.47	3.65
γ 55.0	10.33	10.08	9.81	10.03	9.90	9.86	10.05	10.10	4.02	3.63	3.45	3.53
γ 56.0	10.08	9.84	9.38	9.51	9.62	9.36	9.83	9.71	3.76	3.50	3.19	3.42
γ 57.0	10.05	9.61	9.30	9.21	9.40	9.29	9.64	9.56	3.42	3.73	3.06	3.49
γ 58.0	9.60	9.32	9.10	8.92	9.34	8.95	9.36	9.24	3.48	3.67	2.97	3.15
γ 59.0	9.50	9.03	8.78	8.81	9.16	8.82	9.11	9.02	3.76	3.24	2.91	3.16
γ 60.0	9.18	8.88	8.67	8.69	8.92	8.81	9.02	9.05	3.33	3.05	2.81	2.96
γ 61.0	9.05	8.85	8.61	8.70	8.82	8.57	8.82	8.84	3.59	3.16	2.59	2.62
γ 62.0	8.90	8.58	8.51	8.18	8.67	8.32	8.74	8.73	3.24	3.07	2.55	2.67
γ 63.0	8.54	8.39	8.37	8.28	8.50	8.02	8.60	8.47	3.14	2.88	2.66	2.43
γ 64.0	8.55	8.20	8.04	8.16	8.29	7.91	8.38	8.29	2.96	2.77	2.45	2.49
γ 65.0	8.12	7.84	7.98	7.80	8.19	7.73	8.20	8.08	3.14	2.67	2.32	2.46
γ 66.0	7.80	7.61	8.03	7.68	7.91	7.77	8.01	7.80	2.83	2.40	2.22	2.19
γ 67.0	7.66	7.45	7.45	7.24	7.53	7.60	7.86	7.55	2.81	2.21	2.08	2.20
γ 68.0	7.17	7.44	7.30	6.70	7.17	7.16	7.56	7.30	2.85	2.33	2.20	2.19
γ 69.0	7.34	7.26	7.16	6.67	7.09	7.14	7.20	6.99	2.77	2.52	2.18	2.14
γ 70.0	6.99	7.03	6.78	6.84	7.13	6.99	6.99	7.20	2.90	2.51	2.29	2.25
γ 71.0	6.88	6.79	6.86	6.89	6.89	6.97	6.91	6.81	2.88	2.46	2.13	2.23
γ 72.0	6.94	6.68	6.58	6.66	6.70	6.68	6.67	6.82	2.81	2.45	2.14	2.36
γ 73.0	6.55	6.53	6.54	6.36	6.57	6.57	6.35	6.61	2.85	2.39	2.20	2.27
γ 74.0	6.60	6.32	6.35	6.36	6.38	6.28	6.20	6.31	2.82	2.37	2.29	2.45
γ 75.0	6.76	6.26	6.21	6.19	6.27	6.16	6.24	6.35	2.96	2.50	2.20	2.52
γ 76.0	6.33	5.79	6.19	6.26	6.22	6.25	6.18	6.05	3.12	2.75	2.17	2.34
γ 77.0	6.34	5.69	5.91	5.93	6.28	6.08	6.02	5.78	3.21	2.75	2.19	2.23
γ 78.0	6.29	5.89	5.79	5.84	6.18	5.94	5.88	5.58	3.15	2.77	2.21	2.42
γ 79.0	5.96	5.85	5.71	5.77	6.05	5.95	5.87	5.72	3.06	2.93	2.46	2.42
γ 80.0	6.25	5.74	5.49	5.26	6.11	5.83	5.95	5.64	3.08	2.98	2.47	2.61
γ 81.0	6.12	5.61	5.37	5.27	5.91	5.57	5.77	5.52	2.97	2.83	2.61	2.65
γ 82.0	5.88	5.49	5.54	5.28	5.68	5.54	5.59	5.40	3.29	2.77	2.67	2.86
γ 83.0	5.76	5.30	5.61	5.28	5.56	5.67	5.62	5.41	3.20	2.95	2.63	2.59
γ 84.0	5.68	5.22	5.38	5.18	5.51	5.58	5.52	5.41	3.18	2.93	2.49	2.71
γ 85.0	5.39	5.36	5.38	5.24	5.34	5.64	5.56	5.43	3.29	3.09	2.68	2.64
γ 86.0	5.60	5.32	5.36	4.95	5.07	5.43	5.57	5.38	3.46	3.06	2.71	2.48
γ 87.0	5.34	5.30	5.15	5.05	5.09	5.36	5.37	5.10	3.35	3.14	2.79	2.85
γ 88.0	5.59	5.20	5.05	4.75	5.20	4.95	5.26	5.19	3.47	3.11	2.97	2.42
γ 89.0	5.22	5.07	5.12	4.81	5.18	5.03	5.21	5.04	3.46	3.12	3.05	2.65
γ 90.0	5.18	4.95	4.99	4.83	5.13	4.95	5.13	5.31	3.32	3.10	3.01	2.79
γ 91.0	5.16	4.86	5.12	4.70	4.93	5.04	4.99	5.22	3.29	3.13	2.91	2.71
γ 92.0	5.20	4.99	4.83	4.48	4.82	4.99	5.00	4.83	3.59	3.14	2.98	2.56
γ 93.0	5.08	4.94	4.73	4.80	4.85	5.01	5.07	4.98	3.47	3.08	3.11	2.78

# IES Indoor Report

Photometric Filename:AW12540 10W 1202C9 3090 ZHT35-24D 250.IES

---

## Candela Tabulation - (Cont.)

V/H	C0.0	C22.5	C45.0	C67.5	C90.0	C112.5	C135.0	C157.5	C180.0	C202.5	C225.0	C247.5
γ 94.0	5.00	5.02	4.69	4.56	4.73	4.99	4.99	4.98	3.52	3.29	3.05	2.82
γ 95.0	4.70	4.92	4.76	4.43	4.68	4.94	4.85	4.81	3.68	3.40	3.18	2.84
γ 96.0	4.78	4.70	4.70	4.19	4.70	4.64	4.74	4.60	3.44	3.47	3.00	2.88
γ 97.0	4.70	4.59	4.66	4.33	4.68	4.89	4.61	4.73	3.73	3.36	2.98	3.13
γ 98.0	5.18	4.58	4.60	4.32	4.68	4.85	4.53	4.48	3.58	3.41	3.25	3.00
γ 99.0	4.68	4.57	4.34	4.33	4.56	4.88	4.65	4.32	3.45	3.44	3.31	3.05
γ 100.0	4.71	4.64	4.40	4.26	4.41	4.76	4.85	4.57	3.69	3.46	3.33	2.98
γ 101.0	4.75	4.47	4.39	3.94	4.32	4.72	4.75	4.44	3.72	3.40	3.13	2.71
γ 102.0	4.34	4.31	4.55	4.21	4.32	4.71	4.51	4.20	3.60	3.28	3.34	3.07
γ 103.0	4.96	4.40	4.46	4.05	4.27	4.34	4.54	4.27	3.99	3.23	3.33	3.32
γ 104.0	4.91	4.44	4.28	3.93	4.13	4.52	4.76	4.39	3.67	3.36	3.39	2.98
γ 105.0	4.77	4.52	4.11	4.22	4.30	4.36	4.78	4.46	3.52	3.38	3.48	3.10
γ 106.0	4.87	4.55	4.32	4.16	4.32	4.26	4.64	4.17	3.79	3.43	3.41	3.29
γ 107.0	4.85	4.36	4.20	4.00	4.20	4.13	4.50	4.22	3.81	3.48	3.49	3.16
γ 108.0	4.53	4.33	4.21	4.19	4.23	4.17	4.40	4.09	4.04	3.41	3.25	2.99
γ 109.0	4.29	4.39	4.13	4.01	4.05	4.14	4.47	4.18	3.72	3.38	3.17	2.98
γ 110.0	4.59	4.17	4.24	3.96	4.11	4.18	4.57	4.14	3.72	3.34	3.18	2.94
γ 111.0	4.54	4.03	4.14	4.04	4.21	4.04	4.46	4.08	3.87	3.28	3.26	2.99
γ 112.0	4.60	4.03	4.13	4.12	4.24	3.98	4.36	3.98	3.76	3.27	3.46	3.07
γ 113.0	4.46	4.00	4.17	3.74	4.19	3.90	4.44	3.95	3.79	3.41	3.34	2.87
γ 114.0	4.54	4.01	4.32	3.50	3.97	3.85	4.34	3.97	3.82	3.32	3.41	2.99
γ 115.0	4.52	3.93	4.09	3.75	3.92	3.92	4.36	3.99	3.79	3.31	3.20	3.47
γ 116.0	4.29	3.89	3.95	3.86	3.92	4.05	4.40	3.85	4.03	3.56	3.28	3.40
γ 117.0	4.28	3.89	3.97	3.83	4.00	3.97	4.26	4.15	3.47	3.59	3.21	3.30
γ 118.0	4.67	4.08	3.81	3.64	4.08	3.93	4.30	3.90	3.93	3.56	3.23	3.10
γ 119.0	4.42	4.06	3.67	3.72	4.03	3.89	4.42	3.76	3.49	3.64	3.18	3.23
γ 120.0	4.37	3.90	3.87	3.96	3.99	4.00	4.37	3.98	3.86	3.74	3.24	3.10
γ 121.0	4.30	3.81	3.83	3.79	3.95	3.76	4.24	3.87	3.84	3.77	3.22	3.35
γ 122.0	4.51	3.95	3.85	3.82	3.86	3.83	4.18	3.78	3.98	3.71	3.04	3.41
γ 123.0	4.21	3.93	3.85	3.65	3.96	3.55	4.09	3.98	4.04	3.76	3.06	3.52
γ 124.0	4.33	4.04	3.85	4.09	4.05	3.55	4.10	3.99	3.77	3.65	3.07	3.11
γ 125.0	4.36	3.99	3.77	3.73	3.90	3.86	4.18	3.92	4.08	3.47	3.02	3.19
γ 126.0	4.37	3.97	3.71	3.63	3.90	3.95	4.18	3.90	3.92	3.42	3.26	3.13
γ 127.0	4.03	3.88	3.68	3.68	4.03	3.84	4.05	3.50	3.71	3.61	3.27	3.47
γ 128.0	4.27	3.94	3.67	3.56	3.99	3.70	3.96	3.99	3.87	3.70	3.34	3.44
γ 129.0	4.26	3.92	3.77	3.46	3.92	3.90	4.24	4.08	3.84	3.69	3.24	3.52
γ 130.0	4.59	4.01	3.87	3.38	3.85	3.73	4.35	3.87	3.97	3.71	3.30	3.63
γ 131.0	3.96	4.15	3.54	3.31	3.84	3.84	4.17	3.94	4.27	3.60	3.21	3.45
γ 132.0	4.15	4.10	3.49	3.31	3.94	3.87	4.18	4.00	3.85	3.52	3.13	3.53
γ 133.0	4.20	4.13	3.69	3.36	3.81	3.80	4.26	3.95	3.94	3.54	3.13	3.57
γ 134.0	4.46	4.07	3.71	3.41	3.76	3.61	4.14	3.85	3.88	3.68	3.46	3.48
γ 135.0	4.53	4.05	3.91	3.48	3.99	3.82	3.96	3.68	3.96	3.80	3.33	3.46
γ 136.0	4.44	4.04	4.00	3.40	4.04	3.81	3.94	4.00	3.94	3.77	3.44	3.51
γ 137.0	4.35	4.04	3.79	3.48	3.94	3.71	4.06	3.99	4.02	3.67	3.47	3.68
γ 138.0	4.40	3.94	3.74	3.67	4.08	3.87	4.09	4.16	4.19	3.87	3.39	3.63
γ 139.0	4.26	3.79	3.87	3.28	4.07	3.92	4.18	3.94	3.87	3.80	3.60	3.45
γ 140.0	4.32	3.95	3.86	3.57	3.97	4.00	4.21	3.88	3.87	3.63	3.56	3.62

---

# IES Indoor Report

Photometric Filename:AW12540 10W 1202C9 3090 ZHT35-24D 250.IES

## Candela Tabulation - (Cont.)

V/H	C0. 0	C22. 5	C45. 0	C67. 5	C90. 0	C112. 5	C135. 0	C157. 5	C180. 0	C202. 5	C225. 0	C247. 5
γ 141. 0	4. 48	4. 22	4. 19	3. 73	4. 09	4. 09	4. 20	3. 97	4. 05	3. 71	3. 67	3. 85
γ 142. 0	4. 58	4. 16	3. 79	3. 73	4. 12	4. 11	4. 21	4. 20	4. 21	3. 88	3. 68	3. 73
γ 143. 0	4. 56	4. 09	3. 81	3. 73	3. 92	3. 97	4. 28	3. 91	4. 41	3. 91	3. 44	3. 65
γ 144. 0	4. 50	4. 06	3. 89	3. 57	3. 78	4. 08	4. 24	3. 95	4. 14	4. 01	3. 74	3. 49
γ 145. 0	4. 59	3. 98	3. 78	3. 87	3. 92	4. 13	4. 24	4. 12	4. 13	4. 09	3. 80	3. 62
γ 146. 0	4. 42	4. 09	3. 71	3. 94	3. 99	4. 25	4. 36	4. 11	4. 12	4. 32	3. 99	3. 98
γ 147. 0	4. 88	4. 35	3. 92	3. 91	4. 07	4. 21	4. 39	4. 30	4. 24	4. 31	3. 93	3. 58
γ 148. 0	4. 84	4. 38	4. 07	3. 80	4. 09	4. 55	4. 47	4. 14	4. 43	4. 14	3. 92	3. 90
γ 149. 0	4. 76	4. 40	4. 03	3. 75	4. 05	4. 58	4. 47	4. 21	4. 44	4. 22	3. 75	4. 05
γ 150. 0	4. 84	4. 72	4. 11	4. 01	4. 29	4. 54	4. 54	4. 23	4. 46	4. 32	3. 88	4. 06
γ 151. 0	4. 76	4. 95	4. 24	4. 15	4. 35	4. 32	4. 57	4. 44	4. 67	4. 49	3. 87	4. 07
γ 152. 0	4. 69	4. 84	4. 50	4. 05	4. 42	4. 70	4. 51	4. 59	4. 73	4. 59	4. 14	4. 59
γ 153. 0	4. 85	5. 04	4. 53	4. 26	4. 49	4. 63	4. 68	4. 60	4. 92	4. 67	4. 25	4. 21
γ 154. 0	4. 95	5. 46	4. 37	4. 17	4. 40	4. 66	4. 84	4. 87	4. 85	4. 70	4. 20	4. 18
γ 155. 0	4. 93	5. 71	4. 39	4. 08	4. 62	4. 79	4. 89	4. 75	5. 09	4. 79	4. 24	4. 46
γ 156. 0	5. 01	5. 70	4. 39	4. 16	4. 79	4. 70	4. 86	4. 82	5. 00	4. 95	4. 28	4. 47
γ 157. 0	5. 07	5. 78	4. 66	4. 35	4. 61	4. 80	5. 04	5. 01	5. 03	5. 25	4. 49	4. 37
γ 158. 0	5. 12	5. 49	4. 93	4. 58	4. 57	4. 89	5. 20	4. 93	5. 19	5. 35	4. 63	4. 39
γ 159. 0	5. 34	5. 26	5. 01	4. 61	4. 73	5. 04	5. 13	4. 94	5. 56	5. 25	4. 71	4. 62
γ 160. 0	5. 92	5. 34	5. 13	4. 35	4. 88	4. 97	5. 21	4. 79	5. 79	5. 05	4. 97	4. 86
γ 161. 0	6. 47	5. 39	5. 24	4. 66	4. 98	5. 08	5. 17	4. 78	5. 28	5. 05	4. 89	4. 87
γ 162. 0	6. 72	5. 35	5. 18	4. 80	5. 00	5. 25	5. 27	4. 98	5. 32	5. 07	4. 78	4. 57
γ 163. 0	6. 43	5. 36	5. 25	4. 87	5. 03	5. 38	5. 34	5. 02	6. 09	5. 15	4. 98	4. 86
γ 164. 0	5. 53	5. 43	5. 45	4. 88	5. 01	5. 34	5. 32	5. 17	5. 46	5. 19	4. 79	4. 61
γ 165. 0	5. 56	5. 46	5. 45	5. 01	4. 88	5. 20	5. 43	5. 20	5. 28	5. 15	4. 57	4. 80
γ 166. 0	5. 82	5. 44	5. 42	5. 21	4. 84	5. 42	5. 38	5. 14	5. 61	5. 36	4. 68	4. 86
γ 167. 0	5. 66	5. 37	5. 47	5. 10	5. 01	5. 43	5. 34	5. 27	5. 63	5. 36	4. 99	4. 76
γ 168. 0	5. 11	5. 37	5. 30	4. 84	5. 14	5. 51	5. 35	5. 23	5. 78	5. 31	5. 30	4. 80
γ 169. 0	5. 35	5. 46	5. 37	4. 67	5. 24	5. 54	5. 42	5. 07	5. 84	5. 34	4. 96	4. 58
γ 170. 0	5. 77	5. 54	5. 44	4. 88	5. 36	5. 65	5. 31	5. 25	5. 79	5. 51	4. 77	4. 77
γ 171. 0	5. 38	5. 57	5. 50	5. 11	5. 27	5. 32	5. 31	5. 21	5. 80	5. 43	4. 81	5. 03
γ 172. 0	5. 47	5. 57	5. 37	4. 88	5. 13	5. 40	5. 49	5. 01	5. 68	5. 34	4. 99	4. 98
γ 173. 0	5. 54	5. 57	5. 31	4. 88	5. 22	5. 48	5. 44	5. 07	5. 70	5. 53	5. 03	4. 87
γ 174. 0	5. 46	5. 62	5. 27	5. 00	5. 17	5. 40	5. 53	5. 18	5. 79	5. 43	5. 08	4. 79
γ 175. 0	5. 44	5. 54	5. 28	4. 92	5. 05	5. 43	5. 73	4. 98	5. 79	5. 35	5. 00	5. 05
γ 176. 0	5. 41	5. 39	5. 22	4. 85	5. 09	5. 42	5. 53	5. 10	5. 85	5. 38	5. 13	4. 89
γ 177. 0	5. 80	5. 39	5. 16	5. 04	5. 12	5. 48	5. 35	5. 24	5. 97	5. 34	5. 20	4. 95
γ 178. 0	5. 71	5. 42	5. 08	5. 12	5. 10	5. 49	5. 54	5. 10	5. 60	5. 48	5. 25	4. 77
γ 179. 0	5. 88	5. 43	5. 07	4. 90	5. 14	5. 58	5. 60	5. 35	5. 81	5. 47	5. 17	4. 92
γ 180. 0	5. 31	5. 31	5. 31	5. 31	5. 31	5. 31	5. 31	5. 31	5. 31	5. 31	5. 31	5. 31
V/H	C270. 0	C292. 5	C315. 0	C337. 5								
γ 0. 0	1998. 69	1998. 69	1998. 69	1998. 69								
γ 1. 0	1988. 90	1988. 10	1981. 93	1977. 21								
γ 2. 0	1969. 42	1967. 96	1960. 36	1954. 01								
γ 3. 0	1932. 52	1931. 08	1924. 47	1916. 98								
γ 4. 0	1880. 58	1881. 23	1874. 57	1866. 55								
γ 5. 0	1814. 40	1815. 10	1809. 47	1800. 29								

# IES Indoor Report

Photometric Filename:AW12540 10W 1202C9 3090 ZHT35-24D 250.IES

---

## Candela Tabulation - (Cont.)

V/H	C270. 0	C292. 5	C315. 0	C337. 5
$\gamma$ 6. 0	1734. 82	1735. 88	1732. 11	1722. 09
$\gamma$ 7. 0	1645. 72	1647. 87	1644. 66	1634. 67
$\gamma$ 8. 0	1549. 69	1552. 28	1549. 84	1540. 00
$\gamma$ 9. 0	1448. 99	1452. 22	1449. 92	1441. 38
$\gamma$ 10. 0	1344. 19	1348. 70	1345. 30	1338. 69
$\gamma$ 11. 0	1236. 33	1241. 89	1237. 54	1233. 10
$\gamma$ 12. 0	1127. 15	1133. 68	1128. 37	1126. 95
$\gamma$ 13. 0	1018. 12	1024. 99	1019. 07	1020. 82
$\gamma$ 14. 0	911. 20	918. 26	911. 91	916. 73
$\gamma$ 15. 0	808. 86	815. 53	810. 76	816. 13
$\gamma$ 16. 0	713. 59	720. 19	717. 14	722. 85
$\gamma$ 17. 0	627. 29	634. 73	632. 55	637. 69
$\gamma$ 18. 0	550. 99	558. 77	557. 88	561. 95
$\gamma$ 19. 0	483. 83	490. 72	490. 92	494. 57
$\gamma$ 20. 0	424. 04	428. 98	430. 83	434. 22
$\gamma$ 21. 0	370. 42	373. 56	376. 29	380. 17
$\gamma$ 22. 0	321. 63	322. 68	326. 37	330. 93
$\gamma$ 23. 0	277. 05	277. 06	281. 29	286. 38
$\gamma$ 24. 0	236. 88	237. 05	241. 14	246. 71
$\gamma$ 25. 0	201. 29	201. 52	205. 66	211. 12
$\gamma$ 26. 0	169. 88	169. 62	173. 98	179. 24
$\gamma$ 27. 0	142. 16	141. 81	145. 68	150. 97
$\gamma$ 28. 0	118. 25	117. 32	120. 86	126. 06
$\gamma$ 29. 0	97. 32	96. 85	99. 09	104. 12
$\gamma$ 30. 0	79. 36	78. 71	80. 51	84. 97
$\gamma$ 31. 0	64. 29	63. 80	65. 31	68. 83
$\gamma$ 32. 0	51. 87	51. 32	52. 95	55. 55
$\gamma$ 33. 0	42. 11	41. 80	42. 91	45. 07
$\gamma$ 34. 0	34. 17	34. 19	35. 10	36. 25
$\gamma$ 35. 0	27. 65	27. 60	28. 61	29. 24
$\gamma$ 36. 0	22. 27	22. 19	23. 04	23. 43
$\gamma$ 37. 0	18. 18	17. 92	18. 74	18. 76
$\gamma$ 38. 0	15. 14	14. 94	15. 57	15. 14
$\gamma$ 39. 0	12. 92	13. 19	13. 24	12. 68
$\gamma$ 40. 0	11. 67	11. 75	11. 71	11. 39
$\gamma$ 41. 0	10. 70	10. 94	10. 83	10. 30
$\gamma$ 42. 0	9. 65	9. 97	9. 90	9. 52
$\gamma$ 43. 0	8. 92	9. 17	8. 93	8. 83
$\gamma$ 44. 0	8. 34	8. 51	8. 30	8. 10
$\gamma$ 45. 0	7. 75	7. 88	7. 93	7. 66
$\gamma$ 46. 0	7. 31	7. 55	7. 47	7. 03
$\gamma$ 47. 0	6. 72	7. 03	6. 88	6. 61
$\gamma$ 48. 0	6. 29	6. 44	6. 13	6. 23
$\gamma$ 49. 0	5. 94	5. 95	5. 63	5. 97
$\gamma$ 50. 0	5. 59	5. 54	5. 32	5. 38
$\gamma$ 51. 0	5. 25	4. 92	4. 92	4. 74
$\gamma$ 52. 0	4. 73	4. 99	4. 55	4. 73

---

# IES Indoor Report

Photometric Filename:AW12540 10W 1202C9 3090 ZHT35-24D 250.IES

---

## Candela Tabulation - (Cont.)

V/H	C270. 0	C292. 5	C315. 0	C337. 5
$\gamma$ 53. 0	4. 40	4. 31	4. 29	4. 38
$\gamma$ 54. 0	4. 22	4. 02	4. 07	3. 91
$\gamma$ 55. 0	3. 88	3. 79	3. 84	3. 87
$\gamma$ 56. 0	3. 64	3. 79	3. 61	3. 91
$\gamma$ 57. 0	3. 56	3. 69	3. 47	3. 52
$\gamma$ 58. 0	3. 41	3. 52	3. 47	3. 45
$\gamma$ 59. 0	3. 20	3. 27	3. 40	3. 42
$\gamma$ 60. 0	3. 06	3. 25	3. 14	3. 35
$\gamma$ 61. 0	3. 01	3. 06	3. 01	3. 20
$\gamma$ 62. 0	3. 05	3. 08	3. 04	2. 90
$\gamma$ 63. 0	3. 07	2. 80	2. 95	3. 15
$\gamma$ 64. 0	3. 07	2. 89	2. 88	3. 08
$\gamma$ 65. 0	2. 82	2. 74	2. 95	2. 69
$\gamma$ 66. 0	2. 64	2. 65	2. 89	2. 55
$\gamma$ 67. 0	2. 71	2. 71	2. 76	2. 40
$\gamma$ 68. 0	2. 52	2. 83	2. 67	2. 70
$\gamma$ 69. 0	2. 68	2. 67	2. 65	2. 76
$\gamma$ 70. 0	2. 91	2. 58	2. 64	2. 84
$\gamma$ 71. 0	2. 90	2. 72	2. 73	2. 67
$\gamma$ 72. 0	2. 90	2. 80	2. 72	2. 38
$\gamma$ 73. 0	2. 73	2. 75	2. 63	2. 37
$\gamma$ 74. 0	2. 59	2. 76	2. 71	2. 34
$\gamma$ 75. 0	2. 61	2. 67	2. 74	2. 33
$\gamma$ 76. 0	2. 69	2. 96	2. 77	2. 62
$\gamma$ 77. 0	2. 71	2. 64	2. 79	2. 74
$\gamma$ 78. 0	2. 78	2. 80	2. 85	2. 48
$\gamma$ 79. 0	2. 77	2. 83	2. 87	2. 62
$\gamma$ 80. 0	2. 82	3. 01	2. 89	2. 97
$\gamma$ 81. 0	2. 90	3. 11	2. 97	3. 07
$\gamma$ 82. 0	2. 92	2. 94	2. 94	3. 30
$\gamma$ 83. 0	2. 97	2. 77	3. 00	3. 09
$\gamma$ 84. 0	3. 08	3. 08	2. 96	3. 60
$\gamma$ 85. 0	3. 22	3. 05	2. 95	3. 48
$\gamma$ 86. 0	3. 33	2. 87	3. 11	3. 47
$\gamma$ 87. 0	3. 31	3. 08	3. 26	3. 46
$\gamma$ 88. 0	3. 14	3. 03	3. 47	3. 41
$\gamma$ 89. 0	3. 15	3. 25	3. 44	3. 35
$\gamma$ 90. 0	3. 36	3. 26	3. 25	3. 27
$\gamma$ 91. 0	3. 56	3. 35	3. 26	3. 49
$\gamma$ 92. 0	3. 71	3. 37	3. 36	3. 60
$\gamma$ 93. 0	3. 62	3. 33	3. 32	3. 19
$\gamma$ 94. 0	3. 41	3. 60	3. 35	3. 23
$\gamma$ 95. 0	3. 49	3. 28	3. 42	3. 61
$\gamma$ 96. 0	3. 38	3. 35	3. 52	3. 78
$\gamma$ 97. 0	3. 12	3. 22	3. 49	3. 69
$\gamma$ 98. 0	3. 14	3. 26	3. 48	3. 97
$\gamma$ 99. 0	3. 17	3. 40	3. 61	3. 51

---

# IES Indoor Report

Photometric Filename:AW12540 10W 1202C9 3090 ZHT35-24D 250.IES

---

## Candela Tabulation - (Cont.)

V/H	C270. 0	C292. 5	C315. 0	C337. 5
γ 100. 0	3. 34	3. 58	3. 70	3. 76
γ 101. 0	3. 36	3. 70	3. 65	3. 53
γ 102. 0	3. 26	3. 73	3. 52	3. 83
γ 103. 0	3. 30	3. 47	3. 57	3. 64
γ 104. 0	3. 33	3. 61	3. 47	3. 85
γ 105. 0	3. 45	3. 46	3. 38	3. 43
γ 106. 0	3. 48	3. 59	3. 38	3. 66
γ 107. 0	3. 49	3. 65	3. 52	3. 69
γ 108. 0	3. 53	3. 44	3. 57	3. 45
γ 109. 0	3. 49	3. 67	3. 60	3. 43
γ 110. 0	3. 52	3. 60	3. 67	3. 51
γ 111. 0	3. 42	3. 77	3. 58	3. 56
γ 112. 0	3. 32	3. 77	3. 58	3. 43
γ 113. 0	3. 36	3. 80	3. 59	3. 78
γ 114. 0	3. 46	3. 92	3. 59	3. 70
γ 115. 0	3. 43	3. 80	3. 60	3. 58
γ 116. 0	3. 40	3. 83	3. 57	3. 56
γ 117. 0	3. 61	3. 80	3. 68	3. 48
γ 118. 0	3. 65	3. 73	3. 84	3. 59
γ 119. 0	3. 63	3. 67	3. 89	3. 39
γ 120. 0	3. 76	3. 62	3. 84	3. 54
γ 121. 0	3. 88	3. 76	3. 70	3. 76
γ 122. 0	3. 80	3. 81	3. 48	3. 62
γ 123. 0	3. 75	3. 39	3. 37	3. 72
γ 124. 0	3. 73	3. 69	3. 51	3. 90
γ 125. 0	3. 50	3. 65	3. 64	3. 70
γ 126. 0	3. 49	3. 68	3. 60	3. 71
γ 127. 0	3. 58	3. 76	3. 52	3. 56
γ 128. 0	3. 48	3. 87	3. 65	3. 55
γ 129. 0	3. 57	3. 72	3. 76	3. 61
γ 130. 0	3. 57	3. 78	3. 75	3. 78
γ 131. 0	3. 55	4. 13	3. 72	3. 67
γ 132. 0	3. 59	3. 81	3. 59	3. 62
γ 133. 0	3. 53	3. 61	3. 63	3. 75
γ 134. 0	3. 49	3. 68	3. 88	3. 66
γ 135. 0	3. 41	3. 84	3. 89	3. 78
γ 136. 0	3. 58	3. 92	3. 74	3. 63
γ 137. 0	3. 73	3. 93	3. 63	3. 66
γ 138. 0	3. 70	3. 89	3. 74	3. 77
γ 139. 0	3. 60	4. 03	3. 92	3. 60
γ 140. 0	3. 59	4. 10	3. 92	3. 46
γ 141. 0	3. 62	4. 04	3. 90	3. 69
γ 142. 0	3. 52	4. 26	3. 97	3. 98
γ 143. 0	3. 48	4. 14	4. 07	3. 90
γ 144. 0	3. 71	4. 00	4. 05	3. 86
γ 145. 0	3. 83	4. 13	4. 05	4. 15
γ 146. 0	3. 79	3. 96	4. 09	4. 18

---

# IES Indoor Report

Photometric Filename:AW12540 10W 1202C9 3090 ZHT35-24D 250.IES

---

## Candela Tabulation - (Cont.)

V/H	C270. 0	C292. 5	C315. 0	C337. 5
γ 147. 0	3. 91	4. 21	4. 19	4. 44
γ 148. 0	3. 94	4. 18	4. 24	4. 32
γ 149. 0	4. 12	4. 28	4. 28	4. 37
γ 150. 0	4. 18	4. 29	4. 44	4. 72
γ 151. 0	4. 22	4. 49	4. 48	4. 56
γ 152. 0	4. 39	4. 43	4. 44	4. 40
γ 153. 0	4. 35	4. 50	4. 42	4. 84
γ 154. 0	4. 30	4. 64	4. 51	4. 64
γ 155. 0	4. 41	4. 89	4. 56	4. 83
γ 156. 0	4. 36	4. 64	4. 76	4. 89
γ 157. 0	4. 32	4. 78	5. 03	4. 97
γ 158. 0	4. 51	4. 78	4. 97	4. 84
γ 159. 0	4. 57	4. 82	5. 00	4. 77
γ 160. 0	4. 56	4. 84	5. 19	4. 82
γ 161. 0	4. 53	5. 22	5. 23	4. 88
γ 162. 0	4. 54	5. 29	5. 09	4. 94
γ 163. 0	4. 59	5. 07	5. 02	4. 81
γ 164. 0	4. 83	5. 47	5. 14	4. 84
γ 165. 0	5. 13	5. 48	5. 30	4. 83
γ 166. 0	5. 02	5. 37	5. 31	5. 02
γ 167. 0	4. 89	5. 23	5. 09	4. 85
γ 168. 0	5. 13	5. 21	4. 94	5. 12
γ 169. 0	5. 36	5. 08	4. 95	5. 03
γ 170. 0	5. 23	5. 31	5. 11	5. 09
γ 171. 0	5. 16	5. 18	5. 32	5. 27
γ 172. 0	5. 37	5. 47	5. 43	5. 18
γ 173. 0	5. 34	5. 34	5. 54	5. 20
γ 174. 0	5. 24	5. 34	5. 47	5. 39
γ 175. 0	5. 27	5. 24	5. 41	5. 26
γ 176. 0	5. 27	5. 18	5. 46	4. 91
γ 177. 0	5. 26	5. 43	5. 41	5. 03
γ 178. 0	5. 36	5. 49	5. 30	5. 13
γ 179. 0	5. 32	5. 36	5. 41	5. 43
γ 180. 0	5. 31	5. 31	5. 31	5. 31

---