

IES Indoor Report

Photometric Filename:AD20157-3W-B3535-3090-LDK19.5-15D-AIDIming-700mA.IES

Indoor Luminaire Photometric Data

Description Information

Luminaire Name:AD20157	Lum. Catalog: Downlight	Test ID:
Lamp Name: B3535	Lamp Catalog: COB	Test Date: 2024/01/05
Manufacture:	Shld. Ang(°):15	Test Machine:GON-2000
Test Lab: Test	Frequency(Hz):50	Lamp CCT(K): 3000 Ra: 90
Lum. Size (W*L*H):0.033m*0.033m*0.000m	Lum. Area (m2):0.001	Lum. W(kg): 0.000
Test System: C, γ	Test Step: C=22.5 γ=1.0	Temp. (°C): 25
		Humidity (%): 50.0

Character Parameter

Lamp Speciality Parameter		Luminaire Speciality Parameter	
Rated Flux(lm): 172.860	Luminaire Flux(lm): 172.861	Field Angle(10%Imax): 39.0(°)	
Rated Power(W): 3	Luminaire Efficiency: 100.00%	Down Lumens&Percent: 172.832lm 99.98%	
Rated Voltage(V): 220	Luminaire EER(lm/W): 62.608	Up Lumens&Percent: 0.029lm 0.02%	
Tested Power(W): 2.761	Max. Candela(cd): 1102.439	S/MH: C0_a180=0.327 C90_270=0.329	
Lamps' Inside: 1	Max Cand@Ang. (°): C=270.0 γ=1.0	CIE Type: Semi-Direct	
Tested Electrics(V, A, pf):220.0, 0.025, 0.489	Beam Angle(50%Imax): 19.2(°)	ErP Φ use(90°): 170.825lm	
Lamp Size(W*L*H):0.033m*0.033m*0.000m	Left=-9.2°, Right=10.0°	IRF (%): 1388.257	

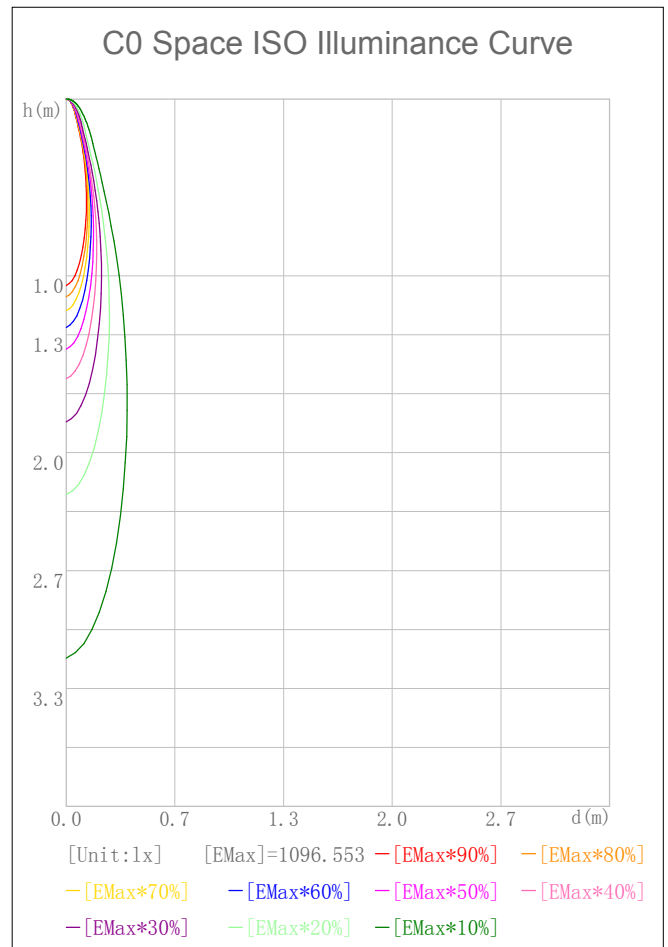
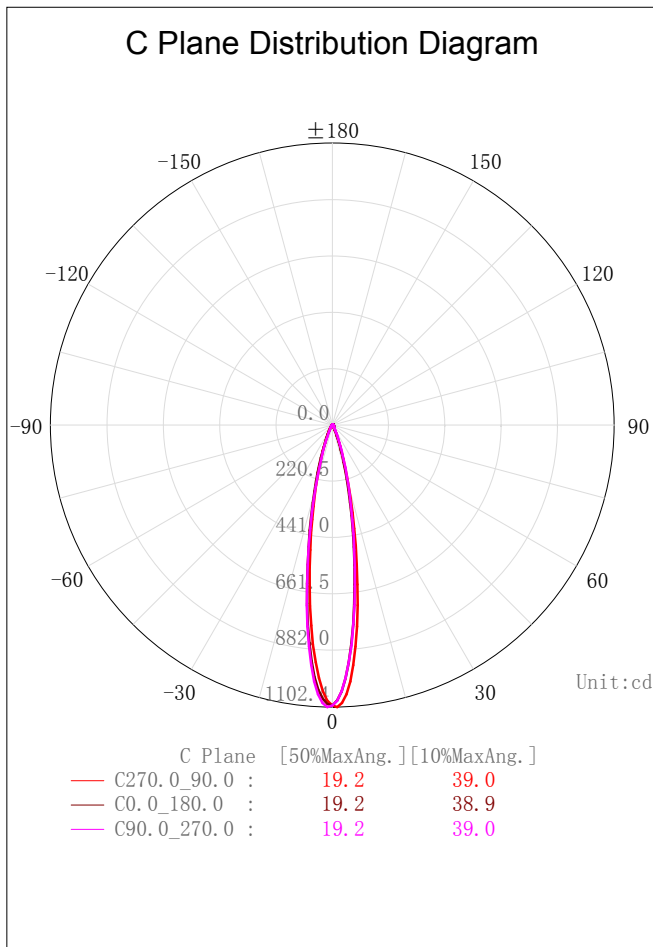

IES Indoor Report

Photometric Filename: **AD20157-3W-B3535-3090-LDK19.5-15D-AIDIming-700mA.IES**

2D Plane Light Intensity Distribution Curve

Lum. Name: AD20157	Lum. Catalog: Downlight	Test ID:
Lamp Name: B3535	Lamp Catalog: COB	Test Lab: Test
Manufacture:	Test Machine: GON-2000	Test Date: 2024/01/05

C Plane Distribution Diagram

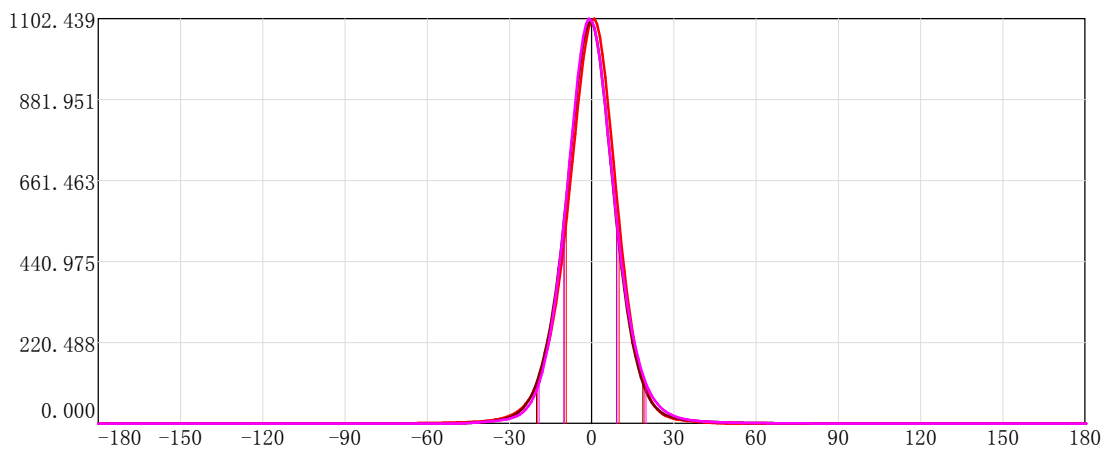
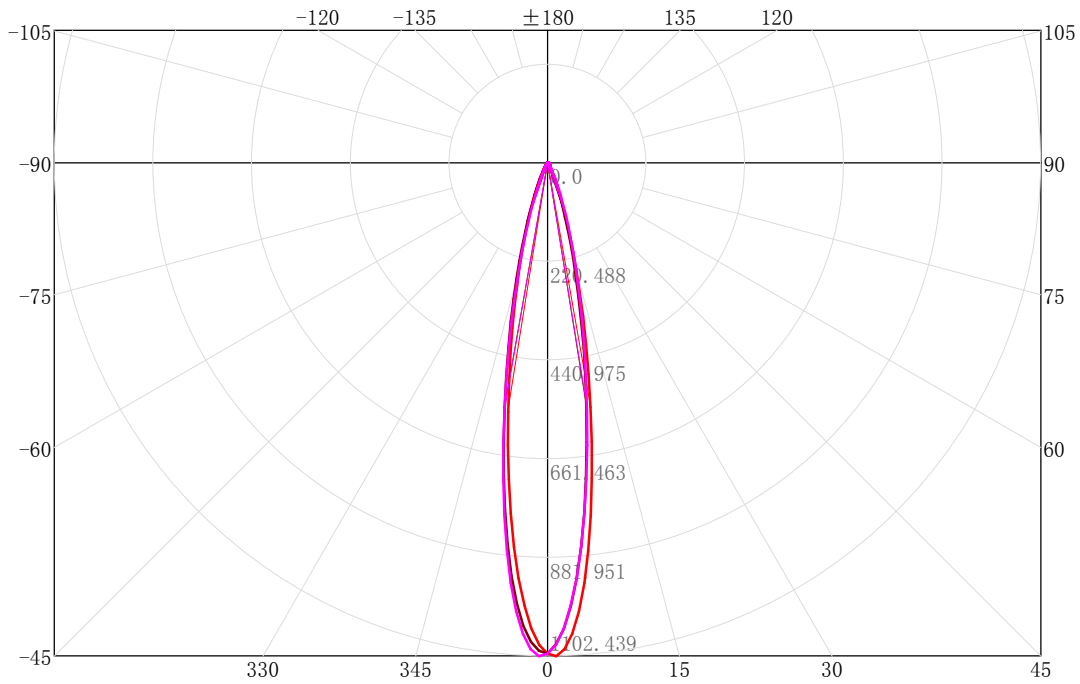

	C Plane	[50%MaxAng.]	[10%MaxAng.]	Unit:cd
—	C270.0_90.0 :	19.2	39.0	
—	C0.0_180.0 :	19.2	38.9	
—	C90.0_270.0 :	19.2	39.0	

IES Indoor Report

Photometric Filename: **AD20157-3W-B3535-3090-LDK19.5-15D-AIDIming-700mA.IES**

3D Light Intensity Distribution Modal

Lum. Name: AD20157	Lum. Catalog: Downlight	Test ID:
Lamp Name: B3535	Lamp Catalog: COB	Test Lab: Test
Manufacture:	Test Machine: GON-2000	Test Date: 2024/01/05

3D Light Intensity Distribution Modal

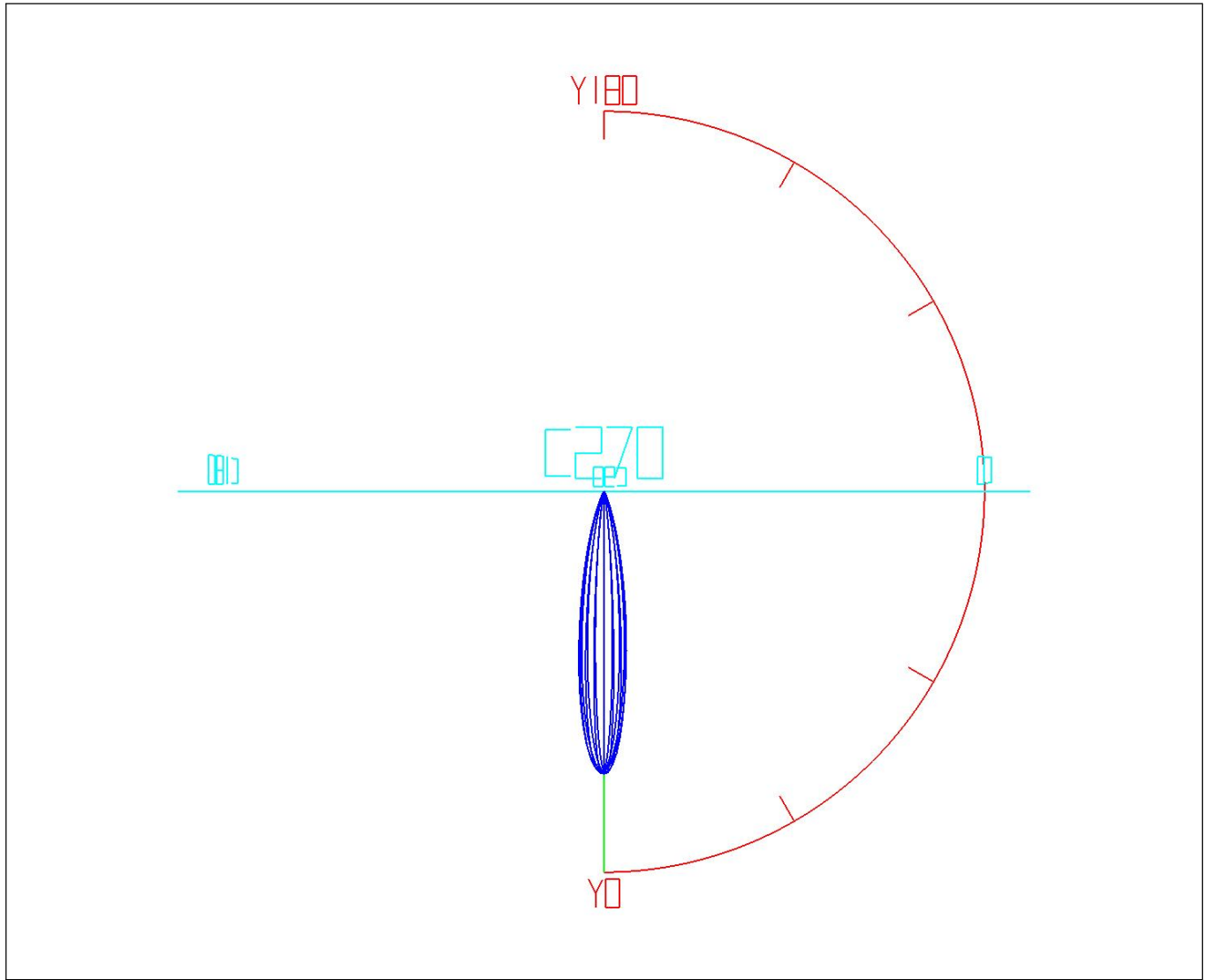

Curves: 3D Model ——— Fixture ——— Vert. HUD ——— Hori. HUD ———
View Angles: Orient:0 Tilt:0 Roll:0 Spin:0

IES Indoor Report

Photometric Filename:AD20157-3W-B3535-3090-LDK19.5-15D-AIDIming-700mA.IES

Zonal Flux Tabulation

Zone (γ)	Zone Flux (lm)	Sums Flux (lm)	Zone%Lamp	Sums%Lamp	Zone (γ)	Zone Flux (lm)	Sums Flux (lm)	Zone%Lamp	Sums%Lamp
0.0-1.0	1.05	1.05	0.60	0.60	47.0-48.0	0.17	170.46	0.10	98.61
1.0-2.0	3.08	4.13	1.78	2.39	48.0-49.0	0.15	170.61	0.09	98.70
2.0-3.0	4.98	9.11	2.88	5.27	49.0-50.0	0.13	170.75	0.08	98.78
3.0-4.0	6.64	15.75	3.84	9.11	50.0-51.0	0.12	170.87	0.07	98.85
4.0-5.0	8.01	23.76	4.64	13.74	51.0-52.0	0.11	170.98	0.07	98.91
5.0-6.0	9.06	32.82	5.24	18.99	52.0-53.0	0.11	171.09	0.06	98.98
6.0-7.0	9.77	42.59	5.65	24.64	53.0-54.0	0.10	171.19	0.06	99.04
7.0-8.0	10.17	52.76	5.88	30.52	54.0-55.0	0.10	171.29	0.06	99.09
8.0-9.0	10.26	63.02	5.94	36.46	55.0-56.0	0.09	171.38	0.05	99.15
9.0-10.0	10.12	73.14	5.85	42.31	56.0-57.0	0.09	171.47	0.05	99.20
10.0-11.0	9.78	82.92	5.66	47.97	57.0-58.0	0.08	171.55	0.05	99.25
11.0-12.0	9.29	92.20	5.37	53.34	58.0-59.0	0.08	171.64	0.05	99.29
12.0-13.0	8.69	100.90	5.03	58.37	59.0-60.0	0.08	171.71	0.04	99.34
13.0-14.0	8.03	108.93	4.65	63.02	60.0-61.0	0.07	171.79	0.04	99.38
14.0-15.0	7.34	116.27	4.25	67.26	61.0-62.0	0.07	171.86	0.04	99.42
15.0-16.0	6.64	122.91	3.84	71.10	62.0-63.0	0.07	171.92	0.04	99.46
16.0-17.0	5.94	128.84	3.43	74.54	63.0-64.0	0.06	171.99	0.04	99.50
17.0-18.0	5.26	134.10	3.04	77.58	64.0-65.0	0.06	172.05	0.04	99.53
18.0-19.0	4.62	138.73	2.67	80.25	65.0-66.0	0.06	172.11	0.03	99.57
19.0-20.0	4.03	142.75	2.33	82.58	66.0-67.0	0.06	172.16	0.03	99.60
20.0-21.0	3.49	146.24	2.02	84.60	67.0-68.0	0.05	172.22	0.03	99.63
21.0-22.0	3.01	149.26	1.74	86.35	68.0-69.0	0.05	172.27	0.03	99.66
22.0-23.0	2.59	151.85	1.50	87.85	69.0-70.0	0.05	172.32	0.03	99.69
23.0-24.0	2.23	154.08	1.29	89.14	70.0-71.0	0.05	172.36	0.03	99.71
24.0-25.0	1.92	156.01	1.11	90.25	71.0-72.0	0.04	172.41	0.03	99.74
25.0-26.0	1.67	157.67	0.96	91.21	72.0-73.0	0.04	172.45	0.02	99.76
26.0-27.0	1.45	159.12	0.84	92.05	73.0-74.0	0.04	172.49	0.02	99.78
27.0-28.0	1.27	160.39	0.74	92.79	74.0-75.0	0.04	172.52	0.02	99.80
28.0-29.0	1.12	161.52	0.65	93.44	75.0-76.0	0.03	172.56	0.02	99.82
29.0-30.0	1.00	162.51	0.58	94.01	76.0-77.0	0.03	172.59	0.02	99.84
30.0-31.0	0.89	163.40	0.51	94.53	77.0-78.0	0.03	172.62	0.02	99.86
31.0-32.0	0.80	164.20	0.46	94.99	78.0-79.0	0.03	172.65	0.02	99.88
32.0-33.0	0.72	164.93	0.42	95.41	79.0-80.0	0.03	172.67	0.01	99.89
33.0-34.0	0.66	165.58	0.38	95.79	80.0-81.0	0.02	172.70	0.01	99.91
34.0-35.0	0.60	166.18	0.35	96.14	81.0-82.0	0.02	172.72	0.01	99.92
35.0-36.0	0.55	166.73	0.32	96.45	82.0-83.0	0.02	172.74	0.01	99.93
36.0-37.0	0.50	167.23	0.29	96.74	83.0-84.0	0.02	172.76	0.01	99.94
37.0-38.0	0.45	167.68	0.26	97.01	84.0-85.0	0.02	172.77	0.01	99.95
38.0-39.0	0.41	168.09	0.24	97.24	85.0-86.0	0.01	172.79	0.01	99.96
39.0-40.0	0.37	168.47	0.22	97.46	86.0-87.0	0.01	172.80	0.01	99.97
40.0-41.0	0.34	168.81	0.20	97.66	87.0-88.0	0.01	172.81	0.01	99.97
41.0-42.0	0.31	169.12	0.18	97.84	88.0-89.0	0.01	172.82	0.01	99.98
42.0-43.0	0.28	169.40	0.16	98.00	89.0-90.0	0.01	172.83	0.01	99.98
43.0-44.0	0.26	169.66	0.15	98.15	90.0-91.0	0.01	172.84	0.00	99.99
44.0-45.0	0.23	169.89	0.14	98.28	91.0-92.0	0.01	172.84	0.00	99.99
45.0-46.0	0.21	170.11	0.12	98.41	92.0-93.0	0.00	172.85	0.00	99.99
46.0-47.0	0.19	170.30	0.11	98.52	93.0-94.0	0.00	172.85	0.00	100.00

-
-
-

IES Indoor Report

Photometric Filename: AD20157-3W-B3535-3090-LDK19.5-15D-AIDIming-700mA.IES

Zonal Flux Tabulation - (Cont.)

Zone (γ)	Zone Flux (lm)	Sums Flux (lm)	Zone%Lamp	Sums%Lamp	Zone (γ)	Zone Flux (lm)	Sums Flux (lm)	Zone%Lamp	Sums%Lamp
94.0-95.0	0.00	172.85	0.00	100.00	141.0-142.0	0.00	172.86	0.00	100.00
95.0-96.0	0.00	172.86	0.00	100.00	142.0-143.0	0.00	172.86	0.00	100.00
96.0-97.0	0.00	172.86	0.00	100.00	143.0-144.0	0.00	172.86	0.00	100.00
97.0-98.0	0.00	172.86	0.00	100.00	144.0-145.0	0.00	172.86	0.00	100.00
98.0-99.0	0.00	172.86	0.00	100.00	145.0-146.0	0.00	172.86	0.00	100.00
99.0-100.0	0.00	172.86	0.00	100.00	146.0-147.0	0.00	172.86	0.00	100.00
100.0-101.0	0.00	172.86	0.00	100.00	147.0-148.0	0.00	172.86	0.00	100.00
101.0-102.0	0.00	172.86	0.00	100.00	148.0-149.0	0.00	172.86	0.00	100.00
102.0-103.0	0.00	172.86	0.00	100.00	149.0-150.0	0.00	172.86	0.00	100.00
103.0-104.0	0.00	172.86	0.00	100.00	150.0-151.0	0.00	172.86	0.00	100.00
104.0-105.0	0.00	172.86	0.00	100.00	151.0-152.0	0.00	172.86	0.00	100.00
105.0-106.0	0.00	172.86	0.00	100.00	152.0-153.0	0.00	172.86	0.00	100.00
106.0-107.0	0.00	172.86	0.00	100.00	153.0-154.0	0.00	172.86	0.00	100.00
107.0-108.0	0.00	172.86	0.00	100.00	154.0-155.0	0.00	172.86	0.00	100.00
108.0-109.0	0.00	172.86	0.00	100.00	155.0-156.0	0.00	172.86	0.00	100.00
109.0-110.0	0.00	172.86	0.00	100.00	156.0-157.0	0.00	172.86	0.00	100.00
110.0-111.0	0.00	172.86	0.00	100.00	157.0-158.0	0.00	172.86	0.00	100.00
111.0-112.0	0.00	172.86	0.00	100.00	158.0-159.0	0.00	172.86	0.00	100.00
112.0-113.0	0.00	172.86	0.00	100.00	159.0-160.0	0.00	172.86	0.00	100.00
113.0-114.0	0.00	172.86	0.00	100.00	160.0-161.0	0.00	172.86	0.00	100.00
114.0-115.0	0.00	172.86	0.00	100.00	161.0-162.0	0.00	172.86	0.00	100.00
115.0-116.0	0.00	172.86	0.00	100.00	162.0-163.0	0.00	172.86	0.00	100.00
116.0-117.0	0.00	172.86	0.00	100.00	163.0-164.0	0.00	172.86	0.00	100.00
117.0-118.0	0.00	172.86	0.00	100.00	164.0-165.0	0.00	172.86	0.00	100.00
118.0-119.0	0.00	172.86	0.00	100.00	165.0-166.0	0.00	172.86	0.00	100.00
119.0-120.0	0.00	172.86	0.00	100.00	166.0-167.0	0.00	172.86	0.00	100.00
120.0-121.0	0.00	172.86	0.00	100.00	167.0-168.0	0.00	172.86	0.00	100.00
121.0-122.0	0.00	172.86	0.00	100.00	168.0-169.0	0.00	172.86	0.00	100.00
122.0-123.0	0.00	172.86	0.00	100.00	169.0-170.0	0.00	172.86	0.00	100.00
123.0-124.0	0.00	172.86	0.00	100.00	170.0-171.0	0.00	172.86	0.00	100.00
124.0-125.0	0.00	172.86	0.00	100.00	171.0-172.0	0.00	172.86	0.00	100.00
125.0-126.0	0.00	172.86	0.00	100.00	172.0-173.0	0.00	172.86	0.00	100.00
126.0-127.0	0.00	172.86	0.00	100.00	173.0-174.0	0.00	172.86	0.00	100.00
127.0-128.0	0.00	172.86	0.00	100.00	174.0-175.0	0.00	172.86	0.00	100.00
128.0-129.0	0.00	172.86	0.00	100.00	175.0-176.0	0.00	172.86	0.00	100.00
129.0-130.0	0.00	172.86	0.00	100.00	176.0-177.0	0.00	172.86	0.00	100.00
130.0-131.0	0.00	172.86	0.00	100.00	177.0-178.0	0.00	172.86	0.00	100.00
131.0-132.0	0.00	172.86	0.00	100.00	178.0-179.0	0.00	172.86	0.00	100.00
132.0-133.0	0.00	172.86	0.00	100.00	179.0-180.0	0.00	172.86	0.00	100.00
133.0-134.0	0.00	172.86	0.00	100.00					
134.0-135.0	0.00	172.86	0.00	100.00					
135.0-136.0	0.00	172.86	0.00	100.00					
136.0-137.0	0.00	172.86	0.00	100.00					
137.0-138.0	0.00	172.86	0.00	100.00					
138.0-139.0	0.00	172.86	0.00	100.00					
139.0-140.0	0.00	172.86	0.00	100.00					
140.0-141.0	0.00	172.86	0.00	100.00					

-
-
-

IES Indoor Report

Photometric Filename: **AD20157-3W-B3535-3090-LDK19.5-15D-AIDIming-700mA.IES**

Rectangle ISO Lighting Intensity Diagram

Lum. Name: AD20157	Lum. Catalog: Downlight	Test ID:
Lamp Name: B3535	Lamp Catalog: COB	Test Lab: Test
Manufacture:	Test Machine: GON-2000	Test Date: 2024/01/05

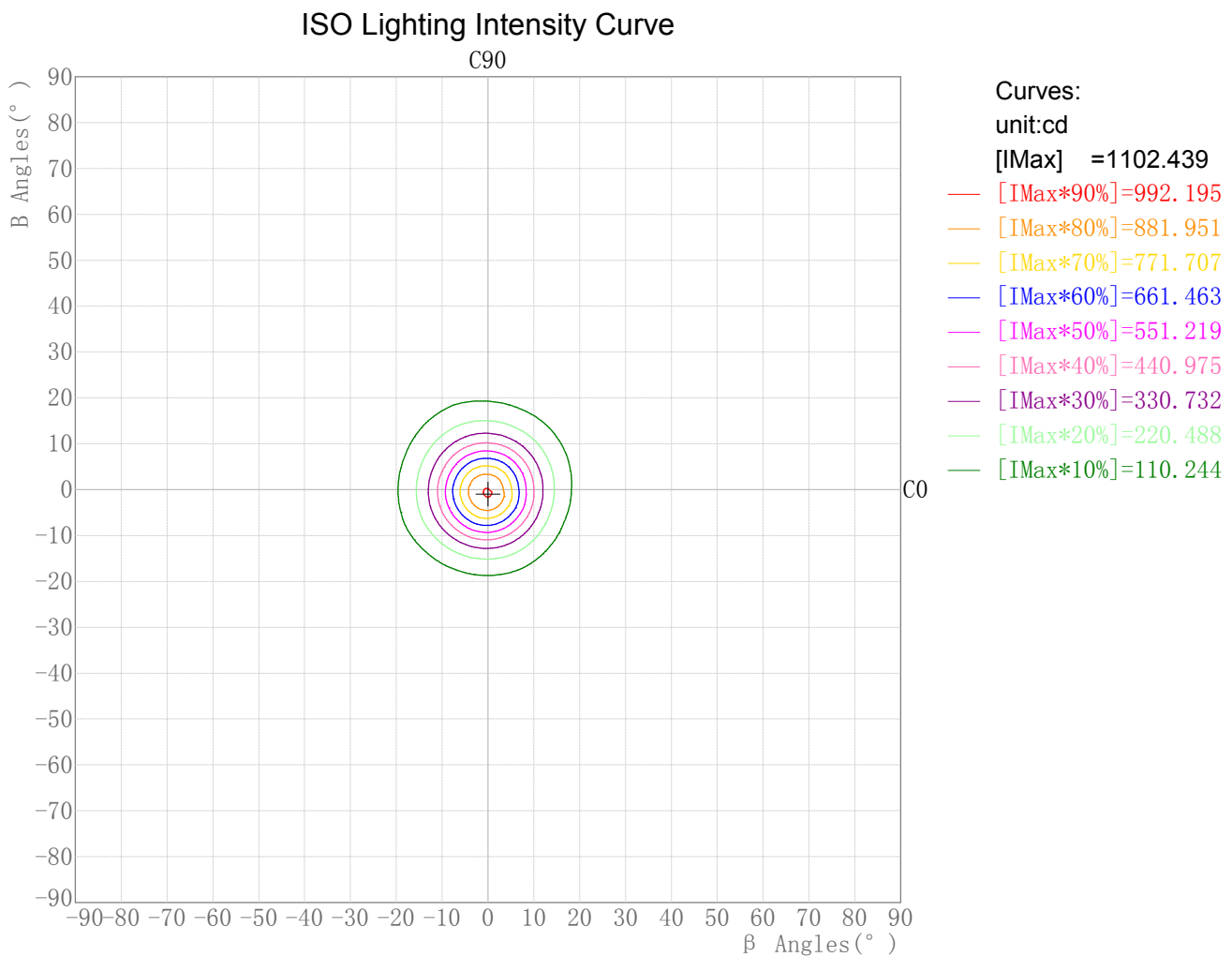

Maximum Light Intensity(cd): 1102.44

Maximum Cand.@Angle: H=-0.0°,V=-1.0°

IES Indoor Report

Photometric Filename: **AD20157-3W-B3535-3090-LDK19.5-15D-AIDIming-700mA.IES**

Round ISO Lighting Intensity Diagram

Lum. Name: AD20157	Lum. Catalog: Downlight	Test ID:
Lamp Name: B3535	Lamp Catalog: COB	Test Lab: Test
Manufacture:	Test Machine: GON-2000	Test Date: 2024/01/05

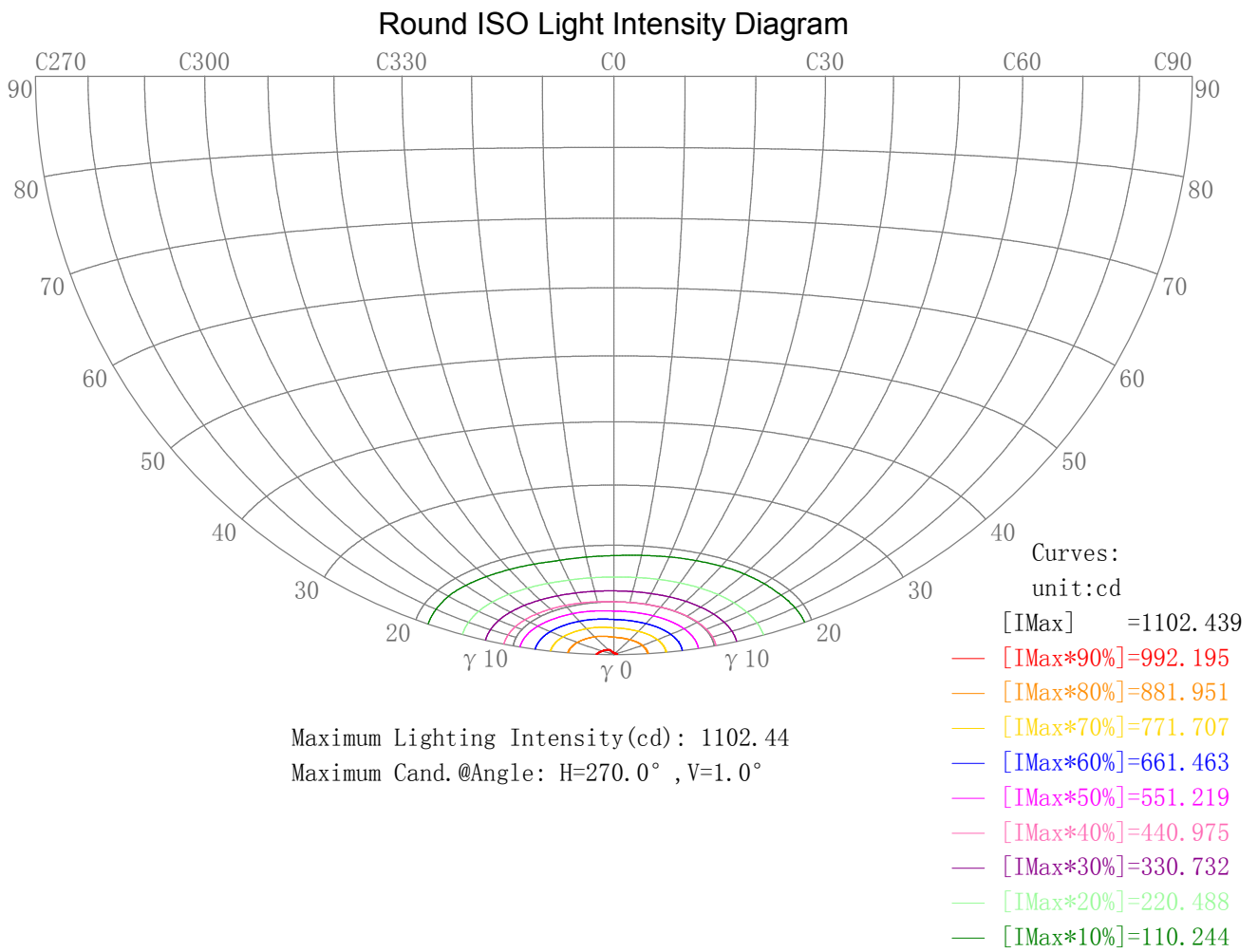

IES Indoor Report

Photometric Filename: **AD20157-3W-B3535-3090-LDK19.5-15D-AIDIming-700mA.IES**

Plane ISO-Illuminance Diagram

Lum. Name: AD20157	Lum. Catalog: Downlight	Test ID:
Lamp Name: B3535	Lamp Catalog: COB	Test Lab: Test
Manufacture:	Test Machine: GON-2000	Test Date: 2024/01/05

Plane ISO-Illuminance Curve

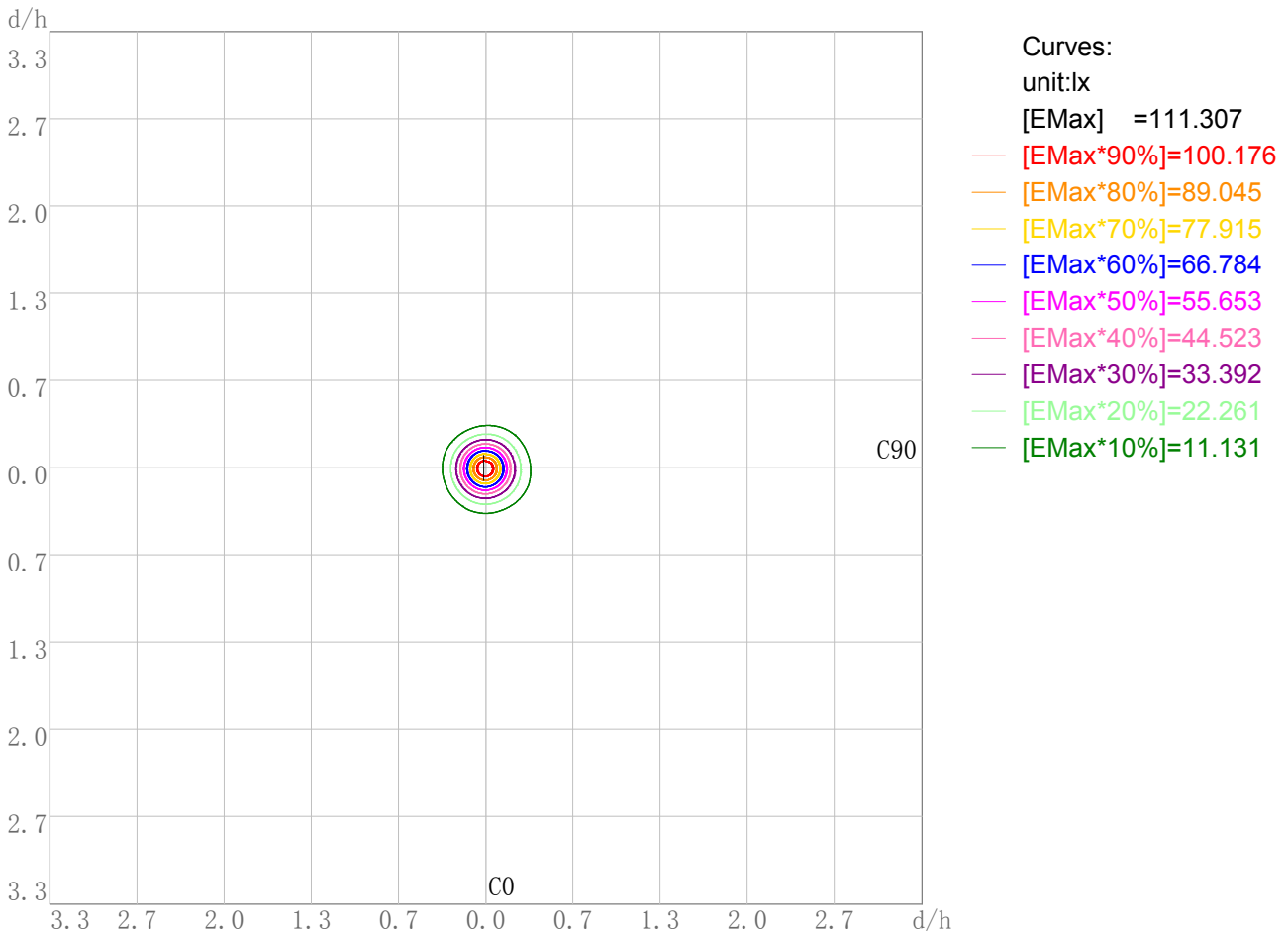

Working Plane Luminaire Mounting Height(m): 3.00
 Working Plane Maximum Illuminance(lx): 111.31
 Working Plane Maximum Illuminance Position(d/h):H-0.0 V-0.0

IES Indoor Report

Photometric Filename: **AD20157-3W-B3535-3090-LDK19.5-15D-AIDIming-700mA.IES**

3D Plane ISO Illuminance Diagram

Lum. Name: AD20157	Lum. Catalog: Downlight	Test ID:
Lamp Name: B3535	Lamp Catalog: COB	Test Lab: Test
Manufacture:	Test Machine: GON-2000	Test Date: 2024/01/05

3D Plane Illuminance Modal

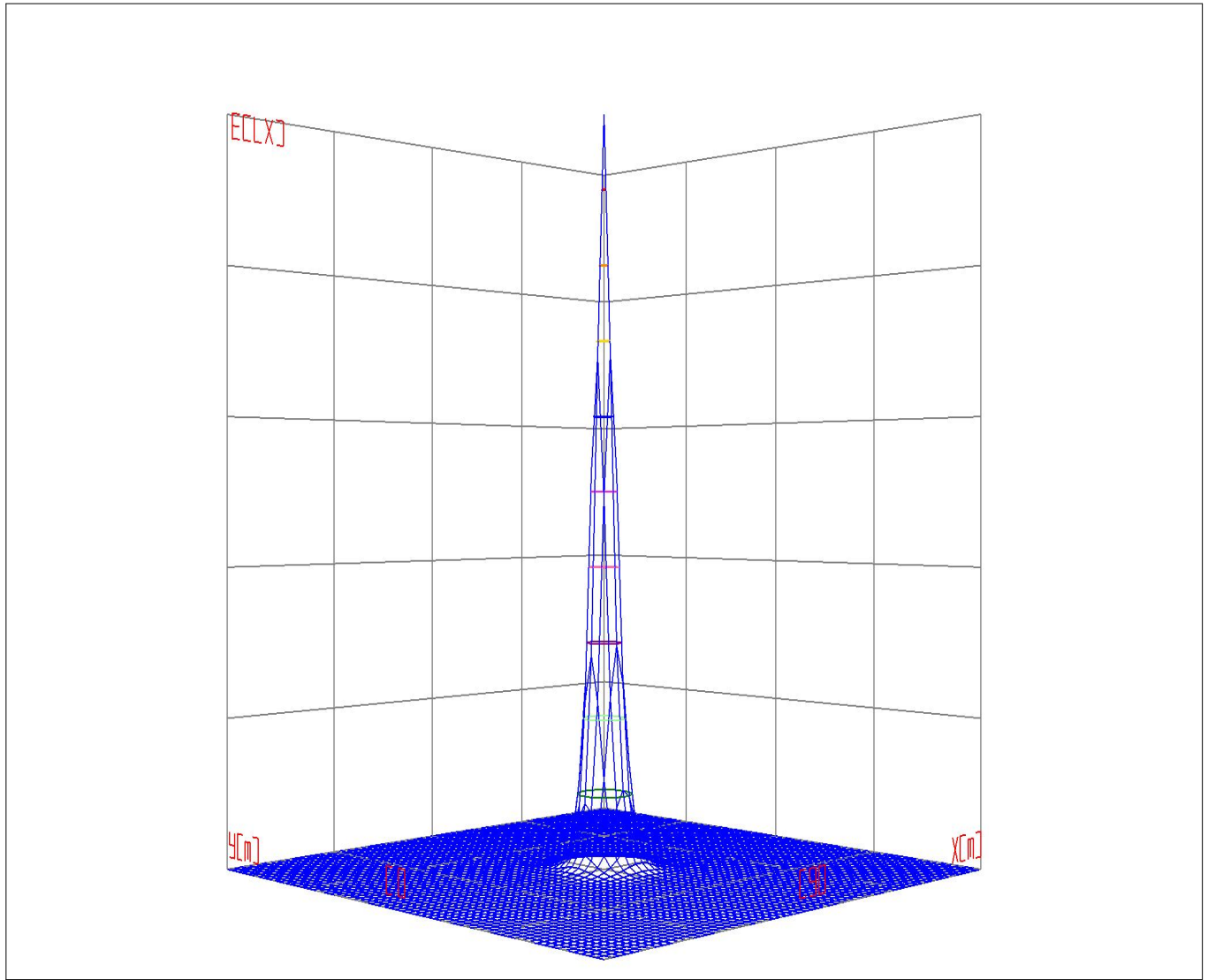

Curves: 3D Model — 90% — 80% — 70% — 60% — 50% — 40% — 30% — 20% — 10% —
View Angles(deg): 0 Height(m): 3.0 Distance(m): 10.0

IES Indoor Report

Photometric Filename: **AD20157-3W-B3535-3090-LDK19.5-15D-AIDIming-700mA.IES**

Space ISO Illuminance Diagram

Lum. Name: AD20157	Lum. Catalog: Downlight	Test ID:
Lamp Name: B3535	Lamp Catalog: COB	Test Lab: Test
Manufacture:	Test Machine: GON-2000	Test Date: 2024/01/05

Space ISO Illuminance Curve



- Curves:
[Unit: lx]
[EMax] = 1096.553
- [EMax*90%]=986.897
 - [EMax*80%]=877.242
 - [EMax*70%]=767.587
 - [EMax*60%]=657.932
 - [EMax*50%]=548.276
 - [EMax*40%]=438.621
 - [EMax*30%]=328.966
 - [EMax*20%]=219.311
 - [EMax*10%]=109.655

Space Plane Maximum Illuminance and @Angle: 1096.55lx, 0.0deg
Plane Maximum Lighting Intensity and @Angle: 1096.553cd, 0deg

IES Indoor Report

Photometric Filename: **AD20157-3W-B3535-3090-LDK19.5-15D-AIDIming-700mA.IES**

Illuminance-Distance Diagram

Lum. Name: AD20157	Lum. Catalog: Downlight	Test ID:
Lamp Name: B3535	Lamp Catalog: COB	Test Lab: Test
Manufacture:	Test Machine: GON-2000	Test Date: 2024/01/05

Illuminance-Distance Curve

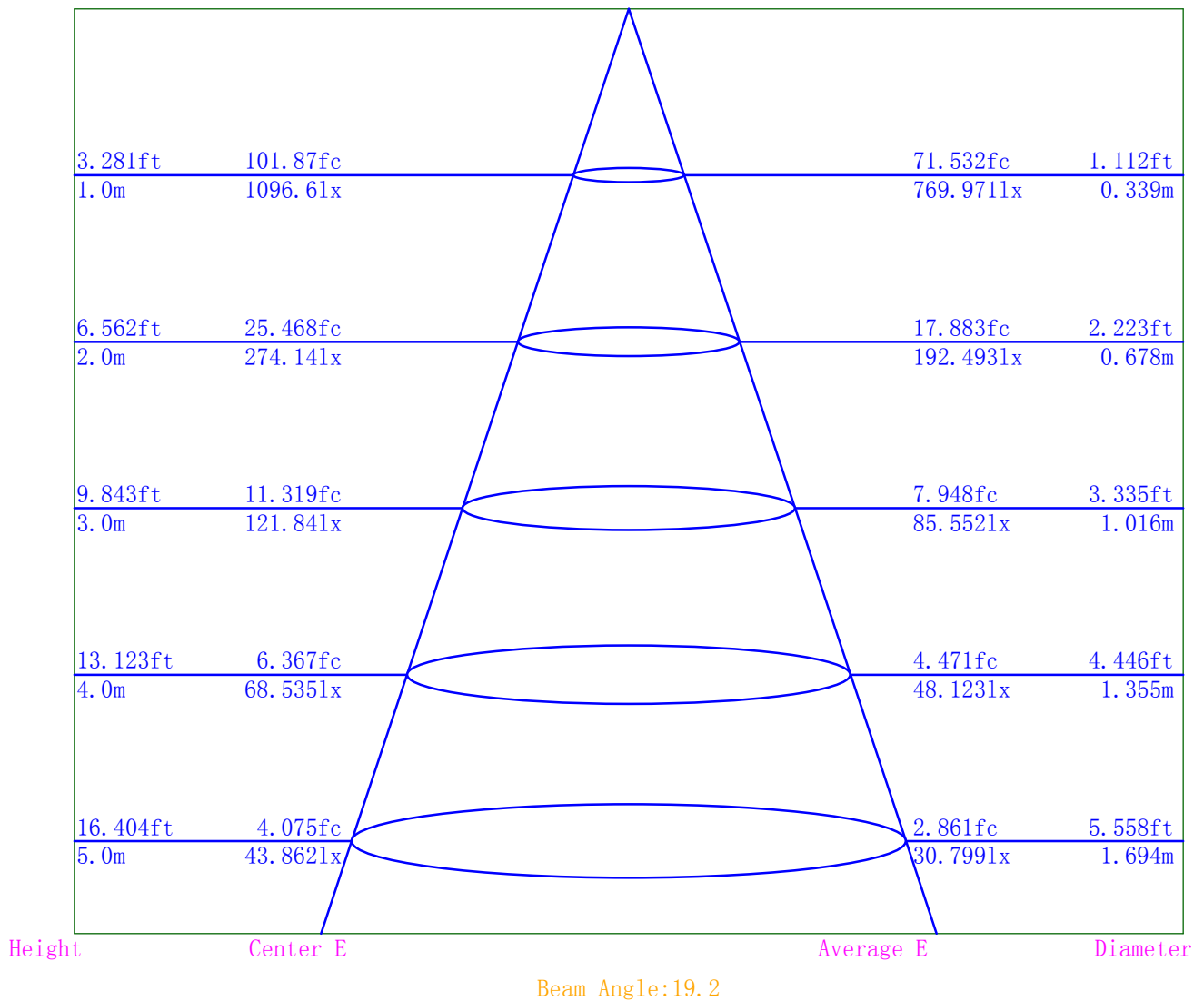

IES Indoor Report

Photometric Filename: **AD20157-3W-B3535-3090-LDK19.5-15D-AIDIming-700mA.IES**

Indoor Luminance Limiting Curves

Lum. Name: AD20157	Lum. Catalog: Downlight	Test ID:
Lamp Name: B3535	Lamp Catalog: COB	Test Lab: Test
Manufacture:	Test Machine: GON-2000	Test Date: 2024/01/05

Glare Grade Table

GI	Quality	Using Illuminance							
		a	b	c	d	e	f	g	h
1.15	A	2000	1000	500	<=300				
1.5	B		2000	1000	500	<=300			
1.85	C			2000	1000	500	<=300		
2.2	D				2000	1000	500	<=300	
2.55	E	a				2000	1000	500	<=300
			b	c	d	e	f	g	h

Luminance Table

Gama (deg)	45	50	55	60	65	70	75	80	85
C0	7210	5622	4664	4144	3834	3693	3876	4170	5947
C90	6846	5312	4256	3663	3235	3087	2857	2926	3674

Luminance Limiting Curve

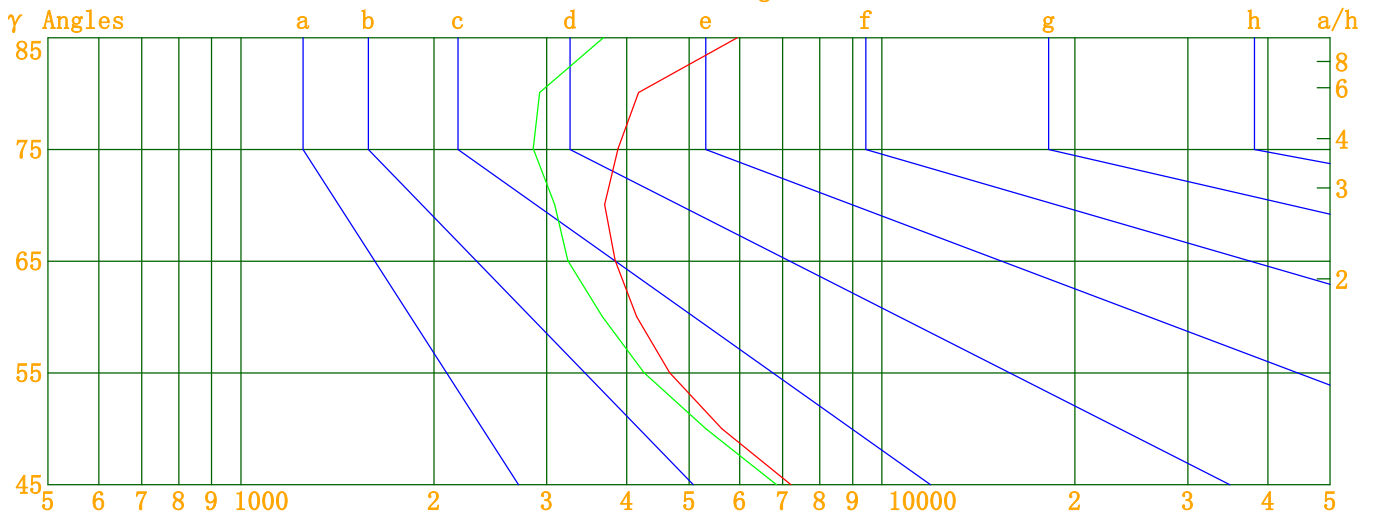

Luminous Size: Length(m)=-0.033 Width(m)=-0.033 Height(m)=0.000 Area(m^2)=0.000855
 Luminous Type: Without Luminous Side
 Luminous Curves: C0-C180 Color: — C90-C270 Color: —

IES Indoor Report

Photometric Filename: AD20157-3W-B3535-3090-LDK19.5-15D-AIDIming-700mA.IES

Indoor Budgetary Estimate Table

Lum. Name: AD20157	Lum. Catalog: Downlight	Test ID:
Lamp Name: B3535	Lamp Catalog: COB	Test Lab: Test
Manufacture:	Test Machine: GON-2000	Test Date: 2024/01/05

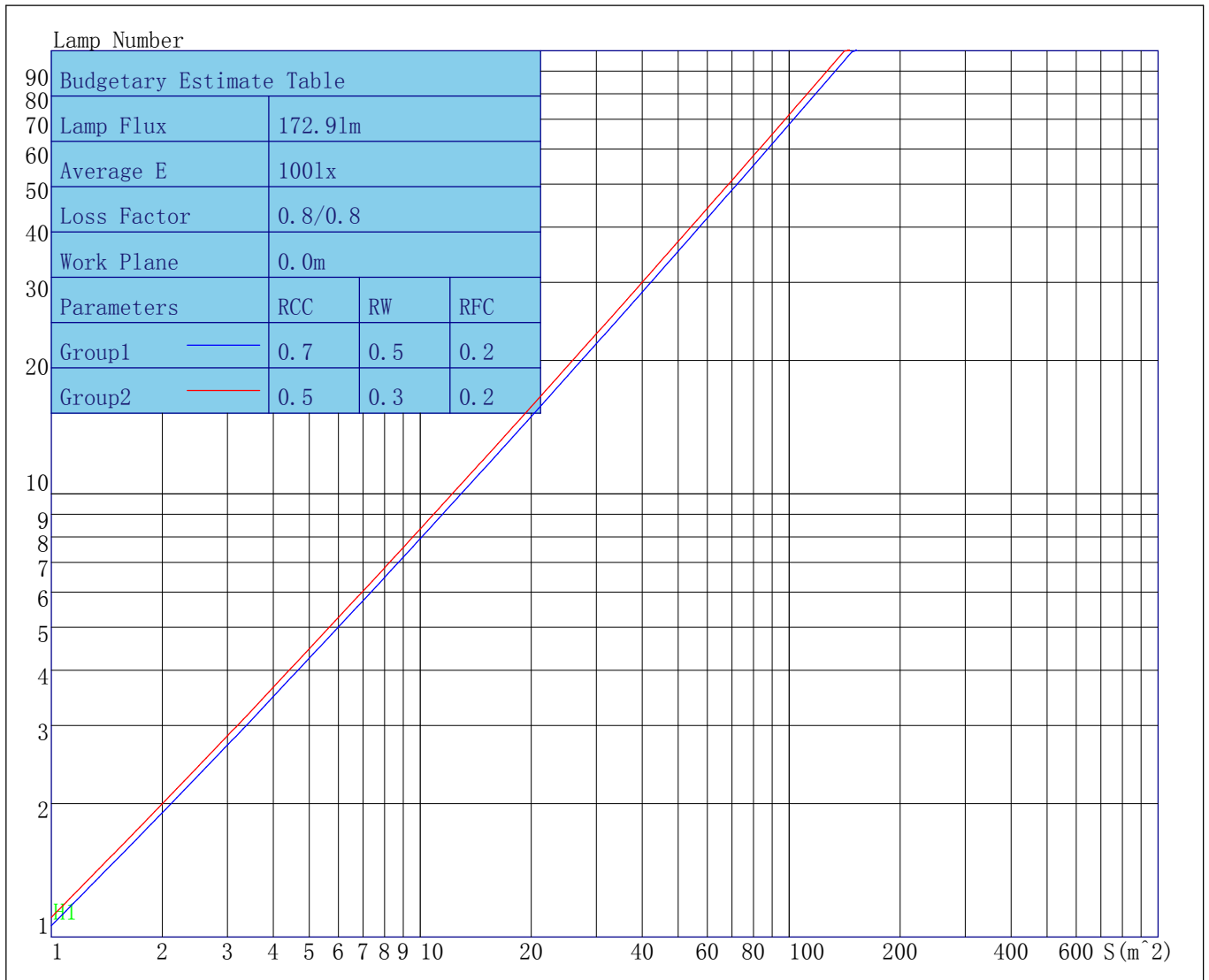

Parameters1: Rhocc = 0.7 Rhow = 0.5 Rhofc = 0.2 LLF = 0.8
 Parameters2: Rhocc = 0.5 Rhow = 0.3 Rhofc = 0.2 LLF = 0.8
 Average Illuminance(lx): 100 Cavity Height: H1(m) = 2

IES Indoor Report

Photometric Filename: **AD20157-3W-B3535-3090-LDK19.5-15D-AIDIming-700mA.IES**

Indoor Coefficient of Utilization Table

Lum. Name: AD20157	Lum. Catalog: Downlight	Test ID:
Lamp Name: B3535	Lamp Catalog: COB	Test Lab: Test
Manufacture:	Test Machine: GON-2000	Test Date: 2024/01/05

Coefficients of Utilization - Zonal Cavity Method																					
Coef.	Effective Floor Cavity Reflectance RFC=0.20																				
RhoCC (%)	80				70				50				30				10				0
RhoW (%)	70	50	30	10	70	50	30	10	50	30	10	50	30	10	50	30	10	50	30	10	0
RCR	Coefficient of Utilization (%)																				
0	119	119	119	119	116	116	116	116	111	111	111	106	106	106	102	102	102	100			
1	115	113	111	109	113	111	109	108	107	106	104	103	102	101	100	99	98	97			
2	111	108	105	102	109	106	104	101	103	101	99	100	99	97	98	96	95	94			
3	108	103	100	97	106	102	99	96	100	97	95	97	95	93	95	94	92	91			
4	105	100	96	93	103	99	95	92	97	94	91	95	92	90	93	91	89	88			
5	102	96	92	89	101	95	92	89	94	91	88	92	90	88	91	89	87	86			
6	99	93	89	86	98	93	89	86	91	88	86	90	87	85	89	86	85	83			
7	97	91	87	84	96	90	86	84	89	86	83	88	85	83	87	84	82	81			
8	94	88	84	81	93	88	84	81	87	83	81	86	83	81	85	82	80	79			
9	92	86	82	79	91	85	82	79	85	81	79	84	81	79	83	80	78	78			
10	90	84	80	77	89	83	80	77	83	79	77	82	79	77	81	79	77	76			

IES Indoor Report

Photometric Filename:AD20157-3W-B3535-3090-LDK19.5-15D-AIDIming-700mA.IES

Unified Glare Rating Table

Lum. Name: AD20157	Lum. Catalog: Downlight	Test ID:
Lamp Name: B3535	Lamp Catalog: COB	Test Lab: Test
Manufacture:	Test Machine:GON-2000	Test Date: 2024/01/05

Unified Glare Rating Table

Ceiling RCC	0.70	0.70	0.50	0.50	0.30	0.70	0.70	0.50	0.50	0.30	
Wall RW	0.50	0.30	0.50	0.30	0.30	0.50	0.30	0.50	0.30	0.30	
Floor RFC	0.20	0.20	0.20	0.20	0.20	0.20	0.20	0.20	0.20	0.20	
Room Size	Vewed crosswise					Vewed endwise					
X=2H	Y=2H	9.3	10.2	9.7	10.5	10.9	11.0	11.9	11.3	12.2	12.5
	Y=3H	10.1	10.9	10.5	11.2	11.6	11.5	12.3	11.9	12.6	13.0
	Y=4H	10.6	11.3	11.0	11.7	12.1	11.8	12.5	12.2	12.9	13.2
	Y=6H	11.2	11.8	11.6	12.2	12.6	12.0	12.7	12.4	13.0	13.4
	Y=8H	11.4	12.1	11.9	12.5	12.9	12.1	12.7	12.6	13.1	13.5
	Y=12H	11.8	12.4	12.2	12.8	13.2	12.2	12.8	12.7	13.2	13.6
X=4H	Y=2H	9.3	10.1	9.8	10.4	10.8	11.1	11.8	11.5	12.2	12.6
	Y=3H	10.2	10.8	10.7	11.2	11.6	11.8	12.4	12.2	12.8	13.2
	Y=4H	10.8	11.3	11.2	11.7	12.2	12.2	12.7	12.6	13.1	13.6
	Y=6H	11.5	11.9	11.9	12.4	12.8	12.6	13.0	13.0	13.5	13.9
	Y=8H	11.8	12.2	12.3	12.7	13.2	12.7	13.1	13.2	13.6	14.1
	Y=12H	12.3	12.7	12.8	13.1	13.6	12.9	13.3	13.4	13.8	14.2
X=8H	Y=4H	10.8	11.2	11.3	11.7	12.1	12.3	12.7	12.8	13.1	13.6
	Y=6H	11.5	11.9	12.1	12.4	12.9	12.8	13.1	13.3	13.6	14.1
	Y=8H	12.0	12.2	12.5	12.8	13.3	13.1	13.3	13.6	13.9	14.4
	Y=12H	12.6	12.8	13.1	13.3	13.9	13.4	13.6	13.9	14.1	14.7
X=12H	Y=4H	10.8	11.1	11.3	11.6	12.1	12.3	12.6	12.7	13.1	13.6
	Y=6H	11.5	11.8	12.1	12.3	12.8	12.8	13.1	13.4	13.6	14.1
	Y=8H	12.0	12.2	12.5	12.7	13.3	13.2	13.4	13.7	13.9	14.5
Variations with the objverer position at spacings											
S=1.0H	0.3/-0.3					0.3/-0.3					
S=1.5H	0.5/-0.4					0.6/-0.7					
S=2.0H	1.3/-0.9					0.8/-0.9					
Reduced UGR Table:											
Nordic Standard Table:	BKO					BKO					
Correction Value	2.2					1.9					

o the CIE Pub. 117, data has been corrected, refers to the lamp's lumens 8.2flm.

-
-
-

IES Indoor Report

Photometric Filename:AD20157-3W-B3535-3090-LDK19.5-15D-AIDIming-700mA.IES

Candela Tabulation

V/H	C0.0	C22.5	C45.0	C67.5	C90.0	C112.5	C135.0	C157.5	C180.0	C202.5	C225.0	C247.5
γ 0.0	1096.55	1096.55	1096.55	1096.55	1096.55	1096.55	1096.55	1096.55	1096.55	1096.55	1096.55	1096.55
γ 1.0	1075.83	1072.60	1074.85	1073.86	1077.60	1080.19	1087.08	1091.44	1090.61	1092.64	1097.73	1098.99
γ 2.0	1041.79	1037.64	1039.20	1037.52	1040.65	1046.25	1057.27	1065.28	1071.00	1076.06	1081.96	1084.24
γ 3.0	991.75	986.98	988.54	987.59	990.52	999.31	1013.83	1024.68	1035.83	1042.76	1049.20	1052.76
γ 4.0	930.40	924.43	926.45	926.58	930.16	940.92	957.45	971.12	986.95	994.48	1001.82	1006.33
γ 5.0	860.38	853.75	856.95	857.21	861.50	873.93	891.36	906.52	925.51	933.61	940.64	946.66
γ 6.0	784.59	778.62	782.07	783.27	787.86	801.88	819.13	834.75	855.45	863.56	870.36	876.59
γ 7.0	706.73	702.18	705.64	707.52	712.81	726.73	744.47	759.65	780.81	788.90	794.13	799.53
γ 8.0	628.98	626.33	629.30	631.83	637.05	650.62	668.04	683.16	703.75	712.20	715.42	718.97
γ 9.0	553.76	553.28	555.77	558.75	564.33	576.93	593.52	607.74	627.59	635.57	637.57	638.68
γ 10.0	484.87	484.52	487.15	490.32	496.12	508.24	523.30	535.95	553.92	561.64	562.20	561.60
γ 11.0	422.03	420.83	424.05	427.28	433.62	445.47	458.85	468.99	484.58	491.55	490.92	488.60
γ 12.0	362.91	363.25	366.79	370.08	377.39	389.01	400.34	408.29	421.32	427.21	425.21	420.72
γ 13.0	309.50	312.05	315.82	318.98	326.88	338.38	347.77	353.85	364.33	369.08	364.85	358.86
γ 14.0	261.64	266.69	270.75	273.77	282.10	293.61	301.24	305.50	313.33	317.10	310.43	303.27
γ 15.0	219.97	227.02	231.76	233.98	242.79	254.36	259.88	262.20	268.35	270.71	262.24	254.13
γ 16.0	183.79	192.17	197.71	198.96	207.63	219.87	223.06	223.35	228.71	229.49	219.59	211.17
γ 17.0	152.62	161.80	167.38	168.31	176.51	189.39	190.46	188.93	193.73	193.46	182.31	173.87
γ 18.0	126.10	135.77	141.32	141.76	149.59	162.35	161.71	158.62	163.10	162.13	150.44	142.09
γ 19.0	103.72	113.39	118.88	118.98	126.46	138.65	137.01	132.63	135.96	135.13	123.04	115.34
γ 20.0	85.00	94.31	99.77	99.57	106.70	118.05	115.89	110.31	112.44	112.41	100.16	93.01
γ 21.0	69.57	78.23	83.61	83.13	89.79	100.25	97.63	91.34	92.46	93.07	81.47	74.75
γ 22.0	57.18	64.84	70.04	69.40	75.56	85.16	82.27	75.74	76.08	76.75	66.03	59.94
γ 23.0	47.20	53.97	58.58	57.95	63.66	72.32	69.30	62.94	62.47	63.31	53.60	48.03
γ 24.0	39.20	45.17	49.03	48.42	53.68	61.42	58.39	52.32	51.10	52.23	43.45	38.61
γ 25.0	32.84	38.02	41.34	40.67	45.46	52.32	49.30	43.56	41.98	43.10	35.43	31.29
γ 26.0	27.91	32.22	35.10	34.39	38.46	44.77	41.64	36.29	34.74	35.71	29.12	25.63
γ 27.0	23.89	27.49	29.99	29.24	32.69	38.56	35.26	30.47	28.87	29.68	24.17	21.28
γ 28.0	20.72	23.62	25.73	24.98	28.09	33.33	29.99	25.80	24.13	24.75	20.20	17.95
γ 29.0	18.19	20.39	22.15	21.49	24.17	28.87	25.66	22.04	20.34	20.67	16.99	15.31
γ 30.0	16.15	17.70	19.28	18.67	21.11	25.16	22.21	19.04	17.08	17.36	14.45	13.21
γ 31.0	14.49	15.54	16.85	16.34	18.23	21.96	19.24	16.65	14.43	14.78	12.45	11.57
γ 32.0	12.98	13.68	14.84	14.38	15.98	19.14	16.77	14.69	12.36	12.70	10.85	10.24
γ 33.0	11.71	12.13	13.10	12.73	14.01	16.72	14.73	13.05	10.61	10.95	9.57	9.08
γ 34.0	10.67	10.87	11.60	11.38	12.43	14.62	13.02	11.66	9.24	9.48	8.41	8.04
γ 35.0	9.82	9.76	10.38	10.26	11.07	12.76	11.59	10.57	8.07	8.24	7.41	7.17
γ 36.0	9.00	8.75	9.23	9.19	9.82	11.01	10.37	9.66	7.13	7.21	6.57	6.42
γ 37.0	8.22	7.84	8.11	8.15	8.57	9.43	9.13	8.79	6.33	6.34	5.88	5.74
γ 38.0	7.52	7.08	7.22	7.26	7.55	8.15	8.06	7.86	5.46	5.49	5.20	5.10
γ 39.0	6.92	6.48	6.55	6.58	6.77	7.17	7.16	7.08	4.63	4.69	4.53	4.48
γ 40.0	6.39	5.95	6.02	6.02	6.16	6.45	6.49	6.43	3.93	4.00	3.92	3.90
γ 41.0	5.91	5.47	5.51	5.52	5.66	5.87	5.94	5.92	3.38	3.40	3.38	3.38
γ 42.0	5.46	5.05	5.13	5.10	5.22	5.39	5.46	5.44	2.84	2.91	2.92	2.89
γ 43.0	5.05	4.65	4.75	4.73	4.85	4.99	5.05	5.02	2.39	2.46	2.45	2.41
γ 44.0	4.68	4.30	4.41	4.39	4.46	4.60	4.68	4.65	1.99	2.03	2.02	1.97
γ 45.0	4.36	4.01	4.06	4.09	4.14	4.24	4.28	4.31	1.62	1.65	1.66	1.57
γ 46.0	4.08	3.75	3.81	3.80	3.89	3.93	4.00	4.00	1.28	1.28	1.29	1.21

-
-
-

IES Indoor Report

Photometric Filename:AD20157-3W-B3535-3090-LDK19.5-15D-AIDIming-700mA.IES

Candela Tabulation - (Cont.)

V/H	C0. 0	C22. 5	C45. 0	C67. 5	C90. 0	C112. 5	C135. 0	C157. 5	C180. 0	C202. 5	C225. 0	C247. 5
γ 47. 0	3.80	3.49	3.54	3.52	3.60	3.67	3.72	3.71	0.92	0.94	0.95	0.88
γ 48. 0	3.53	3.24	3.28	3.28	3.36	3.44	3.46	3.45	0.62	0.64	0.65	0.55
γ 49. 0	3.31	3.00	3.08	3.06	3.12	3.20	3.21	3.22	0.38	0.37	0.37	0.25
γ 50. 0	3.09	2.81	2.88	2.85	2.92	2.98	2.97	3.00	0.15	0.12	0.12	0.01
γ 51. 0	2.91	2.61	2.66	2.66	2.75	2.78	2.77	2.80	0.00	0.00	0.00	0.00
γ 52. 0	2.71	2.44	2.48	2.51	2.54	2.60	2.58	2.60	0.00	0.00	0.00	0.00
γ 53. 0	2.56	2.28	2.34	2.36	2.36	2.42	2.42	2.43	0.00	0.00	0.00	0.00
γ 54. 0	2.41	2.13	2.23	2.19	2.24	2.26	2.28	2.26	0.00	0.00	0.00	0.00
γ 55. 0	2.29	2.00	2.05	2.03	2.09	2.14	2.14	2.13	0.00	0.00	0.00	0.00
γ 56. 0	2.15	1.89	1.95	1.89	1.94	2.00	2.02	2.00	0.00	0.00	0.00	0.00
γ 57. 0	2.04	1.78	1.83	1.81	1.83	1.87	1.89	1.87	0.00	0.00	0.00	0.00
γ 58. 0	1.94	1.68	1.74	1.74	1.74	1.79	1.77	1.76	0.00	0.00	0.00	0.00
γ 59. 0	1.88	1.58	1.61	1.66	1.65	1.70	1.69	1.67	0.00	0.00	0.00	0.00
γ 60. 0	1.77	1.49	1.55	1.57	1.57	1.61	1.60	1.60	0.00	0.00	0.00	0.00
γ 61. 0	1.67	1.42	1.48	1.47	1.49	1.50	1.51	1.51	0.00	0.00	0.00	0.00
γ 62. 0	1.62	1.35	1.37	1.38	1.40	1.42	1.42	1.41	0.00	0.00	0.00	0.00
γ 63. 0	1.52	1.28	1.30	1.31	1.32	1.33	1.35	1.32	0.00	0.00	0.00	0.00
γ 64. 0	1.45	1.21	1.25	1.25	1.26	1.27	1.28	1.24	0.00	0.00	0.00	0.00
γ 65. 0	1.39	1.14	1.18	1.18	1.17	1.21	1.21	1.17	0.00	0.00	0.00	0.00
γ 66. 0	1.32	1.07	1.14	1.11	1.10	1.15	1.14	1.14	0.00	0.00	0.00	0.00
γ 67. 0	1.25	1.02	1.07	1.04	1.05	1.09	1.06	1.06	0.00	0.00	0.00	0.00
γ 68. 0	1.20	0.97	1.01	0.98	1.00	1.01	1.03	1.01	0.00	0.00	0.00	0.00
γ 69. 0	1.16	0.92	0.95	0.92	0.96	0.96	0.95	0.93	0.00	0.00	0.00	0.00
γ 70. 0	1.08	0.89	0.89	0.87	0.90	0.91	0.89	0.87	0.00	0.00	0.00	0.00
γ 71. 0	1.03	0.83	0.84	0.80	0.82	0.86	0.87	0.83	0.00	0.00	0.00	0.00
γ 72. 0	0.98	0.77	0.78	0.76	0.78	0.81	0.81	0.80	0.00	0.00	0.00	0.00
γ 73. 0	0.93	0.71	0.73	0.70	0.71	0.74	0.75	0.75	0.00	0.00	0.00	0.00
γ 74. 0	0.88	0.66	0.70	0.66	0.67	0.70	0.70	0.69	0.00	0.00	0.00	0.00
γ 75. 0	0.86	0.62	0.68	0.63	0.63	0.67	0.67	0.65	0.00	0.00	0.00	0.00
γ 76. 0	0.82	0.59	0.63	0.59	0.57	0.61	0.61	0.60	0.00	0.00	0.00	0.00
γ 77. 0	0.77	0.56	0.54	0.54	0.51	0.57	0.55	0.55	0.00	0.00	0.00	0.00
γ 78. 0	0.71	0.51	0.48	0.49	0.51	0.53	0.51	0.51	0.00	0.00	0.00	0.00
γ 79. 0	0.66	0.47	0.43	0.46	0.47	0.48	0.48	0.49	0.00	0.00	0.00	0.00
γ 80. 0	0.62	0.43	0.41	0.44	0.43	0.44	0.46	0.44	0.00	0.00	0.00	0.00
γ 81. 0	0.58	0.38	0.39	0.40	0.40	0.41	0.43	0.42	0.00	0.00	0.00	0.00
γ 82. 0	0.53	0.35	0.34	0.36	0.38	0.36	0.40	0.37	0.00	0.00	0.00	0.00
γ 83. 0	0.49	0.32	0.32	0.32	0.31	0.34	0.37	0.33	0.00	0.00	0.00	0.00
γ 84. 0	0.49	0.29	0.28	0.28	0.32	0.30	0.34	0.30	0.00	0.00	0.00	0.00
γ 85. 0	0.44	0.26	0.24	0.25	0.27	0.27	0.31	0.29	0.00	0.00	0.00	0.00
γ 86. 0	0.40	0.23	0.21	0.21	0.20	0.25	0.26	0.26	0.00	0.00	0.00	0.00
γ 87. 0	0.37	0.20	0.21	0.18	0.20	0.22	0.23	0.21	0.00	0.00	0.00	0.00
γ 88. 0	0.35	0.16	0.18	0.17	0.20	0.19	0.21	0.19	0.00	0.00	0.00	0.00
γ 89. 0	0.33	0.15	0.13	0.16	0.17	0.15	0.18	0.15	0.00	0.00	0.00	0.00
γ 90. 0	0.29	0.12	0.10	0.12	0.12	0.13	0.15	0.11	0.00	0.00	0.00	0.00
γ 91. 0	0.25	0.09	0.06	0.08	0.08	0.11	0.11	0.09	0.00	0.00	0.00	0.00
γ 92. 0	0.25	0.08	0.05	0.07	0.07	0.07	0.08	0.07	0.00	0.00	0.00	0.00
γ 93. 0	0.24	0.04	0.01	0.03	0.05	0.06	0.08	0.06	0.00	0.00	0.00	0.00

IES Indoor Report

Photometric Filename:AD20157-3W-B3535-3090-LDK19.5-15D-AIDIming-700mA.IES

Candela Tabulation - (Cont.)

V/H	C0.0	C22.5	C45.0	C67.5	C90.0	C112.5	C135.0	C157.5	C180.0	C202.5	C225.0	C247.5
γ 94.0	0.22	0.01	0.02	0.00	0.00	0.03	0.05	0.04	0.00	0.00	0.00	0.00
γ 95.0	0.16	0.00	0.01	0.00	0.00	0.00	0.07	0.01	0.00	0.00	0.00	0.00
γ 96.0	0.15	0.00	0.00	0.00	0.00	0.00	0.03	0.00	0.00	0.00	0.00	0.00
γ 97.0	0.13	0.00	0.00	0.00	0.00	0.00	0.00	0.00	0.00	0.00	0.00	0.00
γ 98.0	0.13	0.00	0.00	0.00	0.00	0.00	0.00	0.00	0.00	0.00	0.00	0.00
γ 99.0	0.11	0.00	0.00	0.00	0.00	0.00	0.00	0.00	0.00	0.00	0.00	0.00
γ 100.0	0.09	0.00	0.00	0.00	0.00	0.00	0.00	0.00	0.00	0.00	0.00	0.00
γ 101.0	0.04	0.00	0.00	0.00	0.00	0.00	0.00	0.00	0.00	0.00	0.00	0.00
γ 102.0	0.00	0.00	0.00	0.00	0.00	0.00	0.00	0.00	0.00	0.00	0.00	0.00
γ 103.0	0.00	0.00	0.00	0.00	0.00	0.00	0.00	0.00	0.00	0.00	0.00	0.00
γ 104.0	0.00	0.00	0.00	0.00	0.00	0.00	0.00	0.00	0.00	0.00	0.00	0.00
γ 105.0	0.01	0.00	0.00	0.00	0.00	0.00	0.00	0.00	0.00	0.00	0.00	0.00
γ 106.0	0.00	0.00	0.00	0.00	0.00	0.00	0.00	0.00	0.00	0.00	0.00	0.00
γ 107.0	0.00	0.00	0.00	0.00	0.00	0.00	0.00	0.00	0.00	0.00	0.00	0.00
γ 108.0	0.00	0.00	0.00	0.00	0.00	0.00	0.00	0.00	0.00	0.00	0.00	0.00
γ 109.0	0.00	0.00	0.00	0.00	0.00	0.00	0.00	0.00	0.00	0.00	0.00	0.00
γ 110.0	0.00	0.00	0.00	0.00	0.00	0.00	0.00	0.00	0.00	0.00	0.00	0.00
γ 111.0	0.00	0.00	0.00	0.00	0.00	0.00	0.00	0.00	0.00	0.00	0.00	0.00
γ 112.0	0.00	0.00	0.00	0.00	0.00	0.00	0.00	0.00	0.00	0.00	0.00	0.00
γ 113.0	0.00	0.00	0.00	0.00	0.00	0.00	0.00	0.00	0.00	0.00	0.00	0.00
γ 114.0	0.00	0.00	0.00	0.00	0.00	0.00	0.00	0.00	0.00	0.00	0.00	0.00
γ 115.0	0.00	0.00	0.00	0.00	0.00	0.00	0.00	0.00	0.00	0.00	0.00	0.00
γ 116.0	0.00	0.00	0.00	0.00	0.00	0.00	0.00	0.00	0.00	0.00	0.00	0.00
γ 117.0	0.00	0.00	0.00	0.00	0.00	0.00	0.00	0.00	0.00	0.00	0.00	0.00
γ 118.0	0.00	0.00	0.00	0.00	0.00	0.00	0.00	0.00	0.00	0.00	0.00	0.00
γ 119.0	0.00	0.00	0.00	0.00	0.00	0.00	0.00	0.00	0.00	0.00	0.00	0.00
γ 120.0	0.00	0.00	0.00	0.00	0.00	0.00	0.00	0.00	0.00	0.00	0.00	0.00
γ 121.0	0.00	0.00	0.00	0.00	0.00	0.00	0.00	0.00	0.00	0.00	0.00	0.00
γ 122.0	0.00	0.00	0.00	0.00	0.00	0.00	0.00	0.00	0.00	0.00	0.00	0.00
γ 123.0	0.00	0.00	0.00	0.00	0.00	0.00	0.00	0.00	0.00	0.00	0.00	0.00
γ 124.0	0.00	0.00	0.00	0.00	0.00	0.00	0.00	0.00	0.00	0.00	0.00	0.00
γ 125.0	0.00	0.00	0.00	0.00	0.00	0.00	0.00	0.00	0.00	0.00	0.00	0.00
γ 126.0	0.00	0.00	0.00	0.00	0.00	0.00	0.00	0.00	0.00	0.00	0.00	0.00
γ 127.0	0.00	0.00	0.00	0.00	0.00	0.00	0.00	0.00	0.00	0.00	0.00	0.00
γ 128.0	0.00	0.00	0.00	0.00	0.00	0.00	0.00	0.00	0.00	0.00	0.00	0.00
γ 129.0	0.00	0.00	0.00	0.00	0.00	0.00	0.00	0.00	0.00	0.00	0.00	0.00
γ 130.0	0.00	0.00	0.00	0.00	0.00	0.00	0.00	0.00	0.00	0.00	0.00	0.00
γ 131.0	0.00	0.00	0.00	0.00	0.00	0.00	0.00	0.00	0.00	0.00	0.00	0.00
γ 132.0	0.00	0.00	0.00	0.00	0.00	0.00	0.00	0.00	0.00	0.00	0.00	0.00
γ 133.0	0.00	0.00	0.00	0.00	0.00	0.00	0.00	0.00	0.00	0.00	0.00	0.00
γ 134.0	0.00	0.00	0.00	0.00	0.00	0.00	0.00	0.00	0.00	0.00	0.00	0.00
γ 135.0	0.00	0.00	0.00	0.00	0.00	0.00	0.00	0.00	0.00	0.00	0.00	0.00
γ 136.0	0.00	0.00	0.00	0.00	0.00	0.00	0.00	0.00	0.00	0.00	0.00	0.00
γ 137.0	0.00	0.00	0.00	0.00	0.00	0.00	0.00	0.00	0.00	0.00	0.00	0.00
γ 138.0	0.00	0.00	0.00	0.00	0.00	0.00	0.00	0.00	0.00	0.00	0.00	0.00
γ 139.0	0.00	0.00	0.00	0.00	0.00	0.00	0.00	0.00	0.00	0.00	0.00	0.00
γ 140.0	0.00	0.00	0.00	0.00	0.00	0.00	0.00	0.00	0.00	0.00	0.00	0.00

-
-
-

IES Indoor Report

Photometric Filename:AD20157-3W-B3535-3090-LDK19.5-15D-AIDIming-700mA.IES

Candela Tabulation - (Cont.)

V/H	C0.0	C22.5	C45.0	C67.5	C90.0	C112.5	C135.0	C157.5	C180.0	C202.5	C225.0	C247.5
γ 141.0	0.00	0.00	0.00	0.00	0.00	0.00	0.00	0.00	0.00	0.00	0.00	0.00
γ 142.0	0.00	0.00	0.00	0.00	0.00	0.00	0.00	0.00	0.00	0.00	0.00	0.00
γ 143.0	0.00	0.00	0.00	0.00	0.00	0.00	0.00	0.00	0.00	0.00	0.00	0.00
γ 144.0	0.00	0.00	0.00	0.00	0.00	0.00	0.00	0.00	0.00	0.00	0.00	0.00
γ 145.0	0.00	0.00	0.00	0.00	0.00	0.00	0.00	0.00	0.00	0.00	0.00	0.00
γ 146.0	0.00	0.00	0.00	0.00	0.00	0.00	0.00	0.00	0.00	0.00	0.00	0.00
γ 147.0	0.00	0.00	0.00	0.00	0.00	0.00	0.00	0.00	0.00	0.00	0.00	0.00
γ 148.0	0.00	0.00	0.00	0.00	0.00	0.00	0.00	0.00	0.00	0.00	0.00	0.00
γ 149.0	0.00	0.00	0.00	0.00	0.00	0.00	0.00	0.00	0.00	0.00	0.00	0.00
γ 150.0	0.00	0.00	0.00	0.00	0.00	0.00	0.00	0.00	0.00	0.00	0.00	0.00
γ 151.0	0.00	0.00	0.00	0.00	0.00	0.00	0.00	0.00	0.00	0.00	0.00	0.00
γ 152.0	0.00	0.00	0.00	0.00	0.00	0.00	0.00	0.00	0.00	0.00	0.00	0.00
γ 153.0	0.00	0.00	0.00	0.00	0.00	0.00	0.00	0.00	0.00	0.00	0.00	0.00
γ 154.0	0.00	0.00	0.00	0.00	0.00	0.00	0.00	0.00	0.00	0.00	0.00	0.00
γ 155.0	0.00	0.00	0.00	0.00	0.00	0.00	0.00	0.00	0.00	0.00	0.00	0.00
γ 156.0	0.00	0.00	0.00	0.00	0.00	0.00	0.00	0.00	0.00	0.00	0.00	0.00
γ 157.0	0.00	0.00	0.00	0.00	0.00	0.00	0.00	0.00	0.00	0.00	0.00	0.00
γ 158.0	0.00	0.00	0.00	0.00	0.00	0.00	0.00	0.00	0.00	0.00	0.00	0.00
γ 159.0	0.00	0.00	0.00	0.00	0.00	0.00	0.00	0.00	0.00	0.00	0.00	0.00
γ 160.0	0.00	0.00	0.00	0.00	0.00	0.00	0.00	0.00	0.00	0.00	0.00	0.00
γ 161.0	0.00	0.00	0.00	0.00	0.00	0.00	0.00	0.00	0.00	0.00	0.00	0.00
γ 162.0	0.06	0.00	0.00	0.00	0.00	0.00	0.00	0.00	0.00	0.00	0.00	0.00
γ 163.0	0.05	0.00	0.00	0.00	0.00	0.00	0.00	0.00	0.00	0.00	0.00	0.00
γ 164.0	0.08	0.00	0.00	0.00	0.00	0.00	0.00	0.00	0.00	0.00	0.00	0.00
γ 165.0	0.09	0.01	0.00	0.00	0.00	0.00	0.00	0.00	0.00	0.00	0.00	0.00
γ 166.0	0.10	0.03	0.00	0.00	0.00	0.00	0.00	0.00	0.00	0.00	0.00	0.00
γ 167.0	0.07	0.02	0.00	0.00	0.00	0.00	0.00	0.00	0.00	0.00	0.00	0.00
γ 168.0	0.07	0.01	0.00	0.00	0.00	0.00	0.00	0.00	0.00	0.00	0.00	0.00
γ 169.0	0.09	0.02	0.00	0.00	0.00	0.00	0.00	0.00	0.00	0.00	0.00	0.00
γ 170.0	0.06	0.02	0.00	0.00	0.00	0.00	0.00	0.00	0.01	0.00	0.00	0.00
γ 171.0	0.09	0.01	0.00	0.00	0.00	0.00	0.00	0.00	0.00	0.00	0.00	0.00
γ 172.0	0.07	0.00	0.00	0.00	0.00	0.00	0.00	0.00	0.00	0.00	0.00	0.00
γ 173.0	0.07	0.00	0.00	0.00	0.00	0.00	0.00	0.00	0.00	0.00	0.00	0.00
γ 174.0	0.07	0.00	0.00	0.00	0.00	0.00	0.00	0.00	0.00	0.00	0.00	0.00
γ 175.0	0.03	0.00	0.00	0.00	0.00	0.00	0.00	0.00	0.01	0.00	0.00	0.00
γ 176.0	0.01	0.00	0.00	0.00	0.00	0.00	0.00	0.00	0.01	0.00	0.00	0.00
γ 177.0	0.02	0.00	0.00	0.00	0.00	0.00	0.00	0.00	0.00	0.00	0.00	0.00
γ 178.0	0.01	0.00	0.00	0.00	0.00	0.00	0.00	0.00	0.00	0.00	0.00	0.00
γ 179.0	0.00	0.00	0.00	0.00	0.00	0.00	0.00	0.00	0.00	0.00	0.00	0.00
γ 180.0	0.00	0.00	0.00	0.00	0.00	0.00	0.00	0.00	0.00	0.00	0.00	0.00
V/H	C270.0	C292.5	C315.0	C337.5								
γ 0.0	1096.55	1096.55	1096.55	1096.55								
γ 1.0	1102.44	1099.01	1096.61	1090.81								
γ 2.0	1087.25	1080.76	1072.99	1062.74								
γ 3.0	1054.00	1044.43	1032.02	1017.68								
γ 4.0	1004.75	991.75	975.44	958.27								
γ 5.0	942.63	926.95	907.46	889.21								

-
-
-

IES Indoor Report

Photometric Filename:AD20157-3W-B3535-3090-LDK19.5-15D-AIDIming-700mA.IES

Candela Tabulation - (Cont.)

V/H	C270. 0	C292. 5	C315. 0	C337. 5
γ 6. 0	870. 98	853. 99	832. 81	813. 51
γ 7. 0	792. 81	775. 81	753. 58	734. 32
γ 8. 0	711. 45	695. 44	673. 25	654. 81
γ 9. 0	631. 09	616. 01	594. 60	577. 22
γ 10. 0	553. 95	539. 87	519. 86	503. 11
γ 11. 0	480. 78	468. 25	449. 58	433. 70
γ 12. 0	413. 10	402. 22	385. 08	370. 28
γ 13. 0	352. 02	342. 90	327. 17	313. 42
γ 14. 0	297. 07	290. 16	275. 65	263. 12
γ 15. 0	249. 01	243. 63	230. 27	219. 33
γ 16. 0	206. 93	202. 86	190. 97	181. 46
γ 17. 0	170. 38	167. 72	156. 89	148. 74
γ 18. 0	139. 78	138. 07	128. 22	121. 07
γ 19. 0	113. 69	112. 95	103. 94	97. 93
γ 20. 0	91. 74	91. 82	83. 92	78. 79
γ 21. 0	73. 91	74. 52	67. 75	63. 40
γ 22. 0	59. 20	60. 28	54. 54	50. 86
γ 23. 0	47. 57	48. 64	43. 85	40. 84
γ 24. 0	38. 29	39. 48	35. 43	33. 00
γ 25. 0	31. 07	32. 32	28. 90	26. 91
γ 26. 0	25. 50	26. 70	23. 95	22. 30
γ 27. 0	21. 24	22. 27	20. 15	18. 79
γ 28. 0	17. 96	18. 78	17. 13	16. 04
γ 29. 0	15. 40	15. 99	14. 71	13. 85
γ 30. 0	13. 38	13. 79	12. 83	12. 10
γ 31. 0	11. 75	12. 03	11. 28	10. 71
γ 32. 0	10. 38	10. 58	9. 99	9. 48
γ 33. 0	9. 21	9. 38	8. 88	8. 38
γ 34. 0	8. 20	8. 34	7. 89	7. 46
γ 35. 0	7. 29	7. 45	7. 10	6. 68
γ 36. 0	6. 55	6. 68	6. 33	5. 97
γ 37. 0	5. 84	5. 95	5. 63	5. 28
γ 38. 0	5. 18	5. 22	4. 92	4. 58
γ 39. 0	4. 56	4. 56	4. 29	3. 98
γ 40. 0	3. 98	3. 97	3. 71	3. 43
γ 41. 0	3. 43	3. 43	3. 17	2. 93
γ 42. 0	2. 92	2. 91	2. 65	2. 46
γ 43. 0	2. 44	2. 41	2. 21	2. 00
γ 44. 0	2. 01	1. 97	1. 78	1. 60
γ 45. 0	1. 61	1. 56	1. 38	1. 24
γ 46. 0	1. 25	1. 17	0. 99	0. 91
γ 47. 0	0. 90	0. 81	0. 65	0. 59
γ 48. 0	0. 58	0. 49	0. 37	0. 32
γ 49. 0	0. 30	0. 23	0. 10	0. 07
γ 50. 0	0. 06	0. 00	0. 00	0. 00
γ 51. 0	0. 00	0. 00	0. 00	0. 00
γ 52. 0	0. 00	0. 00	0. 00	0. 00

IES Indoor Report

Photometric Filename:AD20157-3W-B3535-3090-LDK19.5-15D-AIDIming-700mA.IES

Candela Tabulation - (Cont.)

V/H	C270. 0	C292. 5	C315. 0	C337. 5
γ 53. 0	0. 00	0. 00	0. 00	0. 00
γ 54. 0	0. 00	0. 00	0. 00	0. 00
γ 55. 0	0. 00	0. 00	0. 00	0. 00
γ 56. 0	0. 00	0. 00	0. 00	0. 00
γ 57. 0	0. 00	0. 00	0. 00	0. 00
γ 58. 0	0. 00	0. 00	0. 00	0. 00
γ 59. 0	0. 00	0. 00	0. 00	0. 00
γ 60. 0	0. 00	0. 00	0. 00	0. 00
γ 61. 0	0. 00	0. 00	0. 00	0. 00
γ 62. 0	0. 00	0. 00	0. 00	0. 00
γ 63. 0	0. 00	0. 00	0. 00	0. 00
γ 64. 0	0. 00	0. 00	0. 00	0. 00
γ 65. 0	0. 00	0. 00	0. 00	0. 00
γ 66. 0	0. 00	0. 00	0. 00	0. 00
γ 67. 0	0. 00	0. 00	0. 00	0. 00
γ 68. 0	0. 00	0. 00	0. 00	0. 00
γ 69. 0	0. 00	0. 00	0. 00	0. 00
γ 70. 0	0. 00	0. 00	0. 00	0. 00
γ 71. 0	0. 00	0. 00	0. 00	0. 00
γ 72. 0	0. 00	0. 00	0. 00	0. 00
γ 73. 0	0. 00	0. 00	0. 00	0. 00
γ 74. 0	0. 00	0. 00	0. 00	0. 00
γ 75. 0	0. 00	0. 00	0. 00	0. 00
γ 76. 0	0. 00	0. 00	0. 00	0. 00
γ 77. 0	0. 00	0. 00	0. 00	0. 00
γ 78. 0	0. 00	0. 00	0. 00	0. 00
γ 79. 0	0. 00	0. 00	0. 00	0. 00
γ 80. 0	0. 00	0. 00	0. 00	0. 00
γ 81. 0	0. 00	0. 00	0. 00	0. 00
γ 82. 0	0. 00	0. 00	0. 00	0. 00
γ 83. 0	0. 00	0. 00	0. 00	0. 00
γ 84. 0	0. 00	0. 00	0. 00	0. 00
γ 85. 0	0. 00	0. 00	0. 00	0. 00
γ 86. 0	0. 00	0. 00	0. 00	0. 00
γ 87. 0	0. 00	0. 00	0. 00	0. 00
γ 88. 0	0. 00	0. 00	0. 00	0. 00
γ 89. 0	0. 00	0. 00	0. 00	0. 00
γ 90. 0	0. 00	0. 00	0. 00	0. 00
γ 91. 0	0. 00	0. 00	0. 00	0. 00
γ 92. 0	0. 00	0. 00	0. 00	0. 00
γ 93. 0	0. 00	0. 00	0. 00	0. 00
γ 94. 0	0. 00	0. 00	0. 00	0. 00
γ 95. 0	0. 00	0. 00	0. 00	0. 00
γ 96. 0	0. 00	0. 00	0. 00	0. 00
γ 97. 0	0. 00	0. 00	0. 00	0. 00
γ 98. 0	0. 00	0. 00	0. 00	0. 00
γ 99. 0	0. 00	0. 00	0. 00	0. 00

-
-
-

IES Indoor Report

Photometric Filename:AD20157-3W-B3535-3090-LDK19.5-15D-AIDIming-700mA.IES

Candela Tabulation - (Cont.)

V/H	C270.0	C292.5	C315.0	C337.5
γ 100.0	0.00	0.00	0.00	0.00
γ 101.0	0.00	0.00	0.00	0.00
γ 102.0	0.00	0.00	0.00	0.00
γ 103.0	0.00	0.00	0.00	0.00
γ 104.0	0.00	0.00	0.00	0.00
γ 105.0	0.00	0.00	0.00	0.00
γ 106.0	0.00	0.00	0.00	0.00
γ 107.0	0.00	0.00	0.00	0.00
γ 108.0	0.00	0.00	0.00	0.00
γ 109.0	0.00	0.00	0.00	0.00
γ 110.0	0.00	0.00	0.00	0.00
γ 111.0	0.00	0.00	0.00	0.00
γ 112.0	0.00	0.00	0.00	0.00
γ 113.0	0.00	0.00	0.00	0.00
γ 114.0	0.00	0.00	0.00	0.00
γ 115.0	0.00	0.00	0.00	0.00
γ 116.0	0.00	0.00	0.00	0.00
γ 117.0	0.00	0.00	0.00	0.00
γ 118.0	0.00	0.00	0.00	0.00
γ 119.0	0.00	0.00	0.00	0.00
γ 120.0	0.00	0.00	0.00	0.00
γ 121.0	0.00	0.00	0.00	0.00
γ 122.0	0.00	0.00	0.00	0.00
γ 123.0	0.00	0.00	0.00	0.00
γ 124.0	0.00	0.00	0.00	0.00
γ 125.0	0.00	0.00	0.00	0.00
γ 126.0	0.00	0.00	0.00	0.00
γ 127.0	0.00	0.00	0.00	0.00
γ 128.0	0.00	0.00	0.00	0.00
γ 129.0	0.00	0.00	0.00	0.00
γ 130.0	0.00	0.00	0.00	0.00
γ 131.0	0.00	0.00	0.00	0.00
γ 132.0	0.00	0.00	0.00	0.00
γ 133.0	0.00	0.00	0.00	0.00
γ 134.0	0.00	0.00	0.00	0.00
γ 135.0	0.00	0.00	0.00	0.00
γ 136.0	0.00	0.00	0.00	0.00
γ 137.0	0.00	0.00	0.00	0.00
γ 138.0	0.00	0.00	0.00	0.00
γ 139.0	0.00	0.00	0.00	0.00
γ 140.0	0.00	0.00	0.00	0.00
γ 141.0	0.00	0.00	0.00	0.00
γ 142.0	0.00	0.00	0.00	0.00
γ 143.0	0.00	0.00	0.00	0.00
γ 144.0	0.00	0.00	0.00	0.00
γ 145.0	0.00	0.00	0.00	0.00
γ 146.0	0.00	0.00	0.00	0.00

-
-
-

IES Indoor Report

Photometric Filename:AD20157-3W-B3535-3090-LDK19.5-15D-AIDIming-700mA.IES

Candela Tabulation - (Cont.)

V/H	C270. 0	C292. 5	C315. 0	C337. 5
γ 147. 0	0. 00	0. 00	0. 00	0. 00
γ 148. 0	0. 00	0. 00	0. 00	0. 00
γ 149. 0	0. 00	0. 00	0. 00	0. 00
γ 150. 0	0. 00	0. 00	0. 00	0. 00
γ 151. 0	0. 00	0. 00	0. 00	0. 00
γ 152. 0	0. 00	0. 00	0. 00	0. 00
γ 153. 0	0. 00	0. 00	0. 00	0. 00
γ 154. 0	0. 00	0. 00	0. 00	0. 00
γ 155. 0	0. 00	0. 00	0. 00	0. 00
γ 156. 0	0. 00	0. 00	0. 00	0. 00
γ 157. 0	0. 00	0. 00	0. 00	0. 00
γ 158. 0	0. 00	0. 00	0. 00	0. 00
γ 159. 0	0. 00	0. 00	0. 00	0. 00
γ 160. 0	0. 00	0. 00	0. 00	0. 00
γ 161. 0	0. 00	0. 00	0. 00	0. 00
γ 162. 0	0. 00	0. 00	0. 00	0. 00
γ 163. 0	0. 00	0. 00	0. 00	0. 00
γ 164. 0	0. 00	0. 00	0. 00	0. 00
γ 165. 0	0. 00	0. 00	0. 00	0. 00
γ 166. 0	0. 00	0. 00	0. 00	0. 00
γ 167. 0	0. 00	0. 00	0. 00	0. 00
γ 168. 0	0. 00	0. 00	0. 00	0. 00
γ 169. 0	0. 00	0. 00	0. 00	0. 00
γ 170. 0	0. 00	0. 00	0. 00	0. 00
γ 171. 0	0. 00	0. 00	0. 00	0. 00
γ 172. 0	0. 00	0. 00	0. 00	0. 00
γ 173. 0	0. 00	0. 00	0. 00	0. 00
γ 174. 0	0. 00	0. 00	0. 00	0. 00
γ 175. 0	0. 00	0. 00	0. 00	0. 00
γ 176. 0	0. 00	0. 00	0. 00	0. 00
γ 177. 0	0. 00	0. 00	0. 00	0. 00
γ 178. 0	0. 00	0. 00	0. 00	0. 00
γ 179. 0	0. 00	0. 00	0. 00	0. 00
γ 180. 0	0. 00	0. 00	0. 00	0. 00