

IES Indoor Report

Photometric Filename:AW21020-8W-C-3090-LDK-24D-AIDIming-500MA.IES

Indoor Luminaire Photometric Data

Description Information

Luminaire Name:AW21020	Lum. Catalog: Downlight	Test ID:
Lamp Name: C	Lamp Catalog: COB	Test Date: 2024/01/10
Manufacture:	Shld. Ang(°):24	Test Machine:GON-2000
Test Lab: Test	Frequency(Hz):50	Lamp CCT(K): 3000 Ra: 90
Lum. Size(W*L*H):0.034m*0.034m*0.000m	Lum. Area(m2):0.001	Lum. W(kg): 0.000
Test System: C, γ	Test Step: C=22.5 γ=1.0	Temp.(°C): 25
		Humidity(%): 50.0

Character Parameter

Lamp Speciality Parameter		Luminaire Speciality Parameter	
Rated Flux(lm): 111.660	Luminaire Flux(lm): 111.660	Field Angle(10%Imax): 48.3(°)	
Rated Power(W): 8	Luminaire Efficiency: 100.00%	Down Lumens&Percent: 111.654lm 99.99%	
Rated Voltage(V): 220	Luminaire EER(lm/W): 14.920	Up Lumens&Percent: 0.006lm 0.01%	
Tested Power(W): 7.484	Max. Candela(cd): 474.836	S/MH: C0_a180=0.430 C90_270=0.435	
Lamps' Inside: 1	Max Cand@Ang.(°): C=0.0 γ=4.0	CIE Type: Semi-Direct	
Tested Electrics(V, A, pf):219.7, 0.062, 0.540	Beam Angle(50%Imax): 24.5(°)	ErP Φ use(90°): 109.994lm	
Lamp Size(W*L*H):0.034m*0.034m*0.000m	Left=-10.1°, Right=14.4°	IRF(%): 839.111	

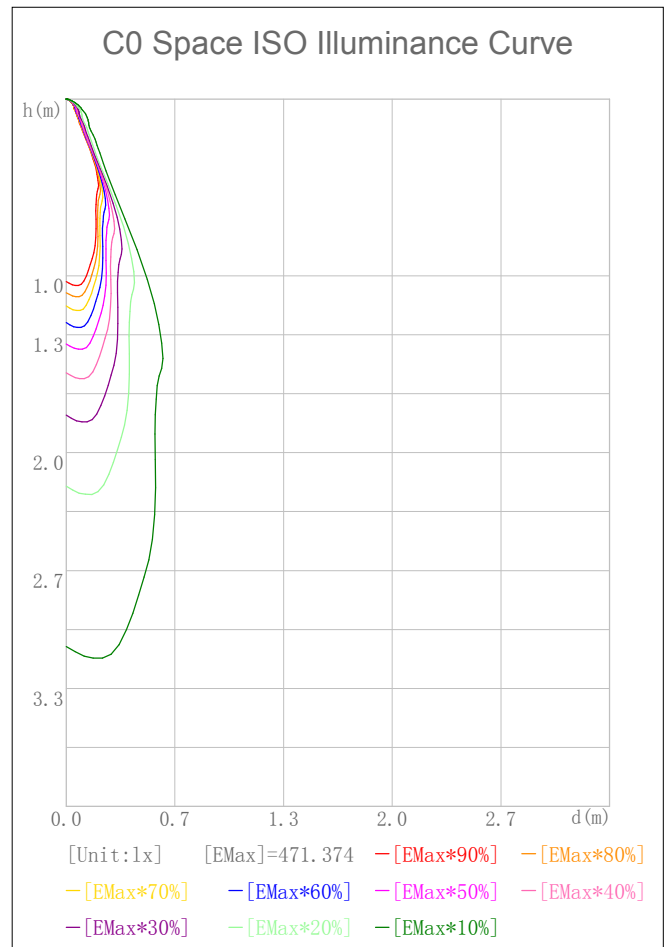
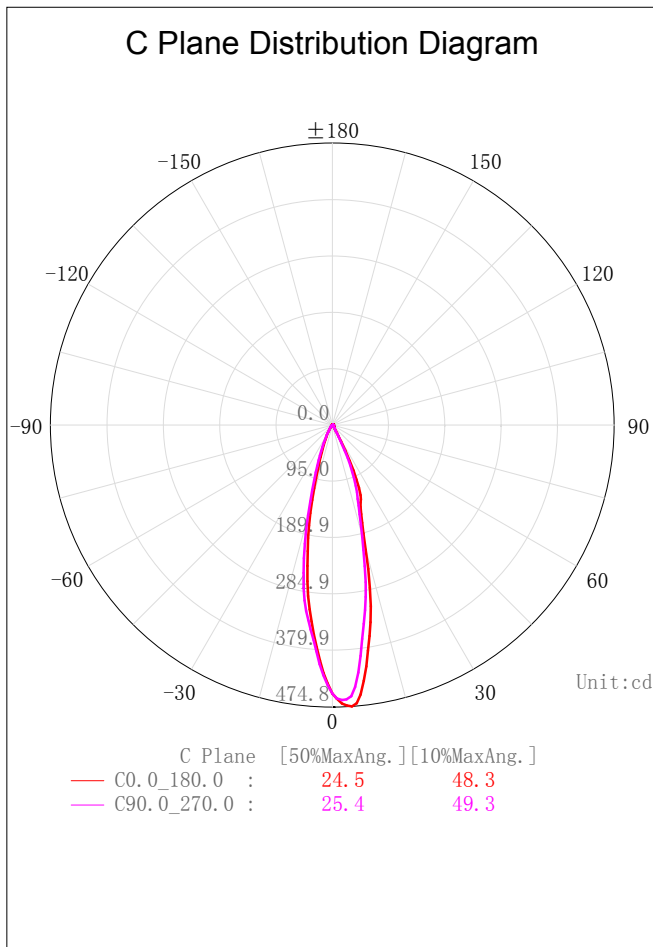

IES Indoor Report

Photometric Filename:AW21020-8W-C-3090-LDK-24D-AIDIming-500MA.IES

2D Plane Light Intensity Distribution Curve

Lum. Name: AW21020	Lum. Catalog: Downlight	Test ID:
Lamp Name: C	Lamp Catalog: COB	Test Lab: Test
Manufacture:	Test Machine:GON-2000	Test Date: 2024/01/10

C Plane Distribution Diagram

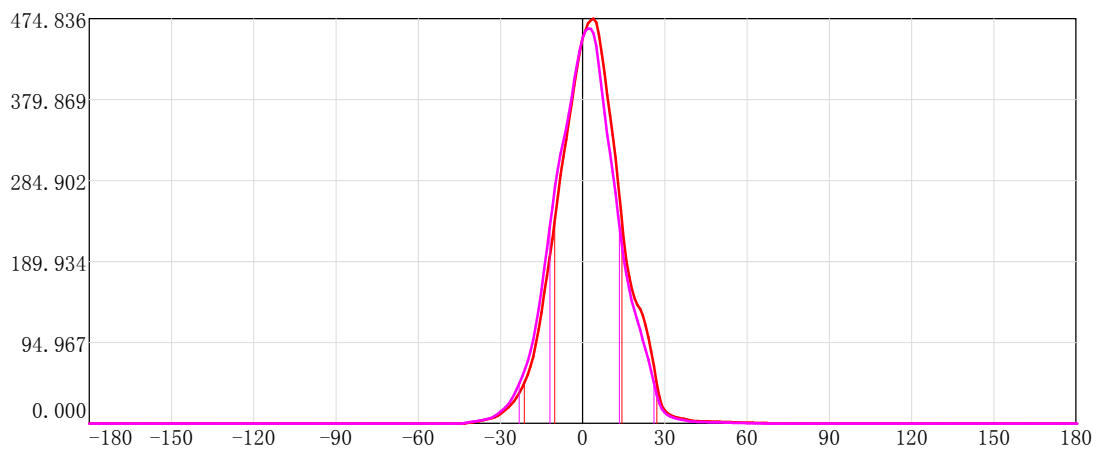
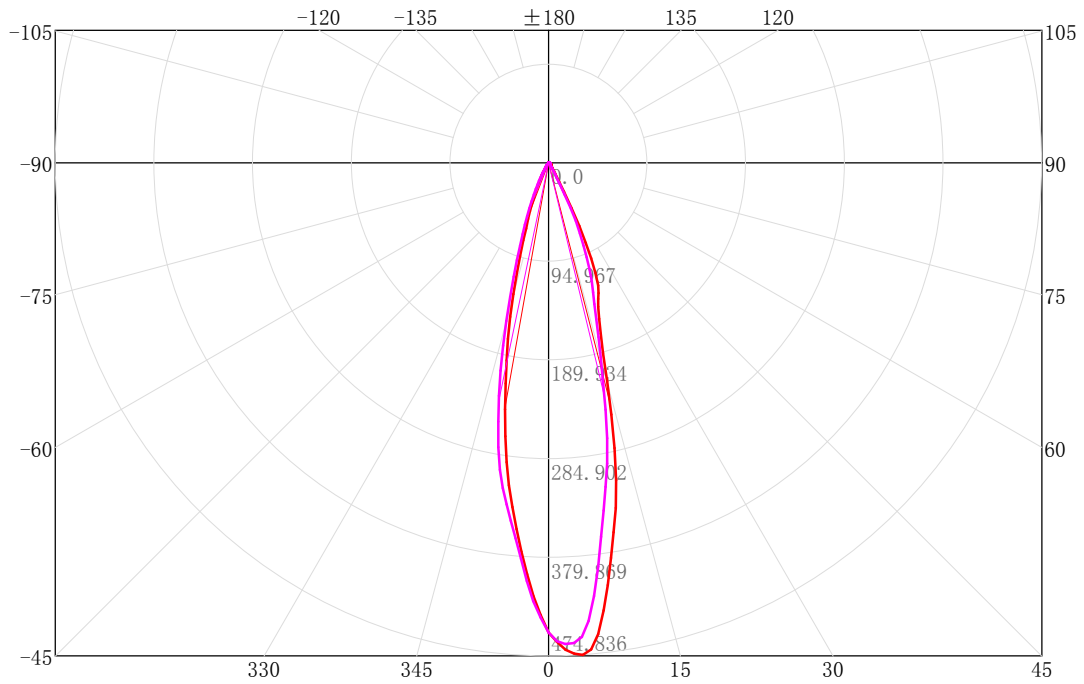

	C Plane	[50%MaxAng.]	[10%MaxAng.]	Unit:cd
—	C0.0_180.0 :	24.5	48.3	
—	C90.0_270.0 :	25.4	49.3	

IES Indoor Report

Photometric Filename:AW21020-8W-C-3090-LDK-24D-AIDIming-500MA.IES

3D Light Intensity Distribution Modal

Lum. Name: AW21020	Lum. Catalog: Downlight	Test ID:
Lamp Name: C	Lamp Catalog: COB	Test Lab: Test
Manufacture:	Test Machine:GON-2000	Test Date: 2024/01/10

3D Light Intensity Distribution Modal

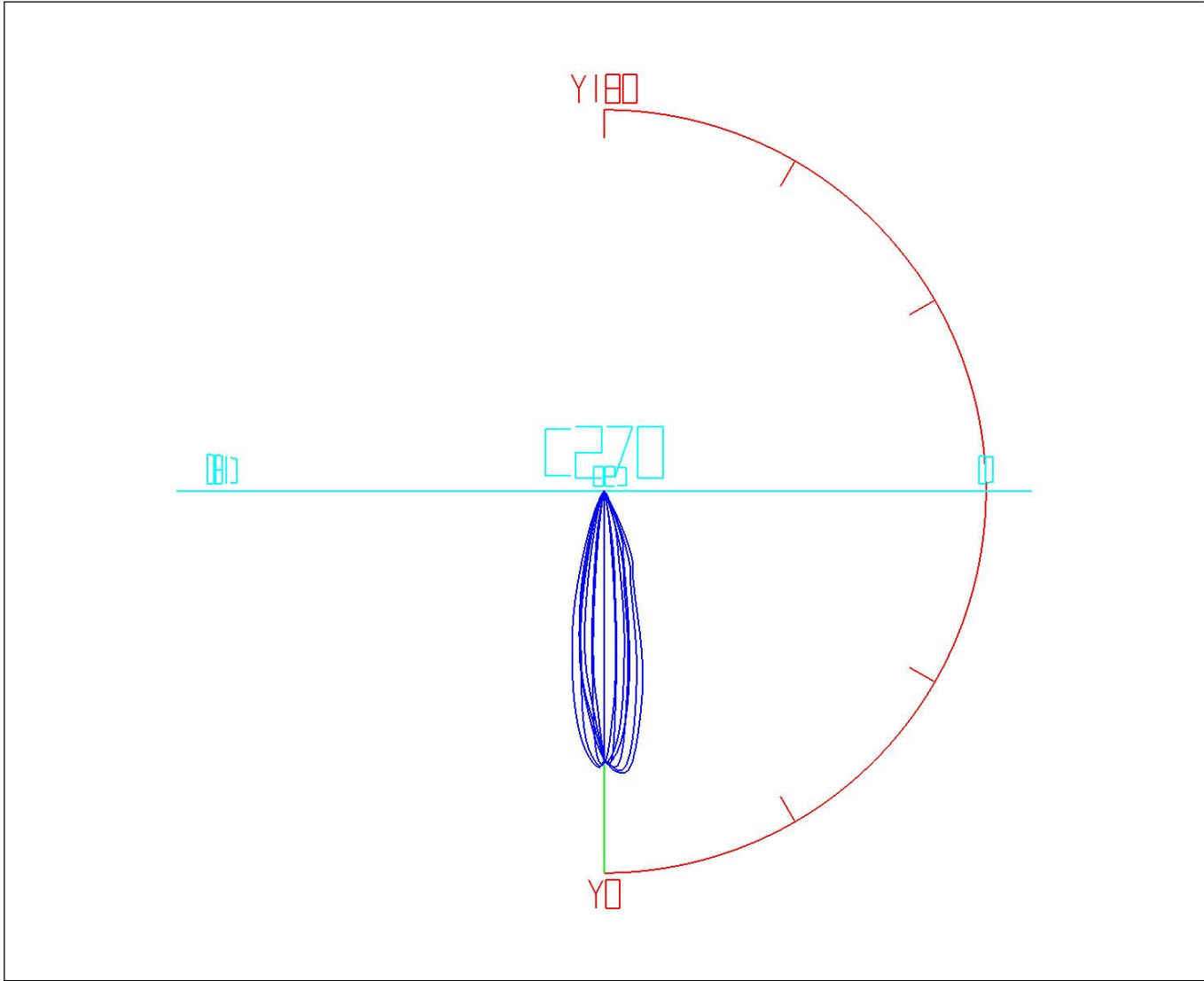

Curves: 3D Model ——— Fixture ——— Vert. HUD ——— Hori. HUD ———
View Angles: Orient:0 Tilt:0 Roll:0 Spin:0

IES Indoor Report

Photometric Filename:AW21020-8W-C-3090-LDK-24D-AIDIming-500MA.IES

Zonal Flux Tabulation

Zone (γ)	Zone Flux (lm)	Sums Flux (lm)	Zone%Lamp	Sums%Lamp	Zone (γ)	Zone Flux (lm)	Sums Flux (lm)	Zone%Lamp	Sums%Lamp
0.0-1.0	0.43	0.43	0.39	0.39	47.0-48.0	0.07	110.81	0.06	99.24
1.0-2.0	1.28	1.71	1.15	1.54	48.0-49.0	0.07	110.88	0.06	99.31
2.0-3.0	2.10	3.82	1.88	3.42	49.0-50.0	0.07	110.95	0.06	99.37
3.0-4.0	2.88	6.69	2.58	5.99	50.0-51.0	0.07	111.02	0.06	99.42
4.0-5.0	3.59	10.28	3.21	9.21	51.0-52.0	0.06	111.08	0.06	99.48
5.0-6.0	4.21	14.49	3.77	12.97	52.0-53.0	0.06	111.14	0.05	99.53
6.0-7.0	4.72	19.21	4.23	17.20	53.0-54.0	0.06	111.20	0.05	99.58
7.0-8.0	5.12	24.33	4.59	21.79	54.0-55.0	0.05	111.25	0.05	99.63
8.0-9.0	5.40	29.73	4.84	26.63	55.0-56.0	0.05	111.30	0.04	99.68
9.0-10.0	5.59	35.32	5.01	31.63	56.0-57.0	0.04	111.34	0.04	99.72
10.0-11.0	5.68	41.01	5.09	36.72	57.0-58.0	0.04	111.38	0.04	99.75
11.0-12.0	5.68	46.69	5.09	41.81	58.0-59.0	0.04	111.42	0.03	99.79
12.0-13.0	5.57	52.26	4.99	46.80	59.0-60.0	0.03	111.46	0.03	99.82
13.0-14.0	5.37	57.63	4.81	51.61	60.0-61.0	0.03	111.49	0.03	99.84
14.0-15.0	5.11	62.73	4.57	56.18	61.0-62.0	0.03	111.51	0.03	99.87
15.0-16.0	4.81	67.55	4.31	60.49	62.0-63.0	0.03	111.54	0.02	99.89
16.0-17.0	4.52	72.07	4.05	64.55	63.0-64.0	0.02	111.56	0.02	99.91
17.0-18.0	4.26	76.33	3.82	68.36	64.0-65.0	0.02	111.58	0.02	99.93
18.0-19.0	4.03	80.36	3.61	71.97	65.0-66.0	0.02	111.60	0.01	99.94
19.0-20.0	3.81	84.17	3.41	75.38	66.0-67.0	0.01	111.61	0.01	99.96
20.0-21.0	3.60	87.77	3.23	78.61	67.0-68.0	0.01	111.62	0.01	99.97
21.0-22.0	3.37	91.14	3.02	81.62	68.0-69.0	0.01	111.63	0.01	99.97
22.0-23.0	3.10	94.24	2.77	84.40	69.0-70.0	0.01	111.64	0.01	99.98
23.0-24.0	2.78	97.02	2.49	86.89	70.0-71.0	0.00	111.64	0.00	99.98
24.0-25.0	2.43	99.44	2.17	89.06	71.0-72.0	0.00	111.64	0.00	99.99
25.0-26.0	2.04	101.48	1.83	90.89	72.0-73.0	0.00	111.65	0.00	99.99
26.0-27.0	1.65	103.13	1.47	92.36	73.0-74.0	0.00	111.65	0.00	99.99
27.0-28.0	1.30	104.43	1.16	93.52	74.0-75.0	0.00	111.65	0.00	99.99
28.0-29.0	1.02	105.45	0.92	94.44	75.0-76.0	0.00	111.65	0.00	99.99
29.0-30.0	0.82	106.27	0.74	95.17	76.0-77.0	0.00	111.65	0.00	99.99
30.0-31.0	0.67	106.94	0.60	95.78	77.0-78.0	0.00	111.65	0.00	99.99
31.0-32.0	0.56	107.51	0.50	96.28	78.0-79.0	0.00	111.65	0.00	99.99
32.0-33.0	0.48	107.98	0.43	96.71	79.0-80.0	0.00	111.65	0.00	99.99
33.0-34.0	0.41	108.40	0.37	97.08	80.0-81.0	0.00	111.65	0.00	99.99
34.0-35.0	0.36	108.76	0.33	97.40	81.0-82.0	0.00	111.65	0.00	99.99
35.0-36.0	0.32	109.08	0.29	97.69	82.0-83.0	0.00	111.65	0.00	99.99
36.0-37.0	0.29	109.37	0.26	97.95	83.0-84.0	0.00	111.65	0.00	99.99
37.0-38.0	0.25	109.62	0.22	98.17	84.0-85.0	0.00	111.65	0.00	99.99
38.0-39.0	0.21	109.84	0.19	98.37	85.0-86.0	0.00	111.65	0.00	99.99
39.0-40.0	0.18	110.02	0.16	98.53	86.0-87.0	0.00	111.65	0.00	99.99
40.0-41.0	0.16	110.17	0.14	98.67	87.0-88.0	0.00	111.65	0.00	99.99
41.0-42.0	0.13	110.31	0.12	98.79	88.0-89.0	0.00	111.65	0.00	99.99
42.0-43.0	0.11	110.42	0.10	98.89	89.0-90.0	0.00	111.65	0.00	99.99
43.0-44.0	0.10	110.51	0.09	98.97	90.0-91.0	0.00	111.65	0.00	99.99
44.0-45.0	0.08	110.60	0.07	99.05	91.0-92.0	0.00	111.65	0.00	99.99
45.0-46.0	0.08	110.67	0.07	99.11	92.0-93.0	0.00	111.65	0.00	99.99
46.0-47.0	0.07	110.74	0.07	99.18	93.0-94.0	0.00	111.65	0.00	99.99

-
-
-

IES Indoor Report

Photometric Filename:AW21020-8W-C-3090-LDK-24D-AIDIming-500MA.IES

Zonal Flux Tabulation - (Cont.)

Zone (γ)	Zone Flux (lm)	Sums Flux (lm)	Zone%Lamp	Sums%Lamp	Zone (γ)	Zone Flux (lm)	Sums Flux (lm)	Zone%Lamp	Sums%Lamp
94.0-95.0	0.00	111.65	0.00	99.99	141.0-142.0	0.00	111.65	0.00	99.99
95.0-96.0	0.00	111.65	0.00	99.99	142.0-143.0	0.00	111.65	0.00	99.99
96.0-97.0	0.00	111.65	0.00	99.99	143.0-144.0	0.00	111.65	0.00	99.99
97.0-98.0	0.00	111.65	0.00	99.99	144.0-145.0	0.00	111.65	0.00	99.99
98.0-99.0	0.00	111.65	0.00	99.99	145.0-146.0	0.00	111.65	0.00	99.99
99.0-100.0	0.00	111.65	0.00	99.99	146.0-147.0	0.00	111.65	0.00	99.99
100.0-101.0	0.00	111.65	0.00	99.99	147.0-148.0	0.00	111.65	0.00	99.99
101.0-102.0	0.00	111.65	0.00	99.99	148.0-149.0	0.00	111.65	0.00	99.99
102.0-103.0	0.00	111.65	0.00	99.99	149.0-150.0	0.00	111.65	0.00	99.99
103.0-104.0	0.00	111.65	0.00	99.99	150.0-151.0	0.00	111.65	0.00	99.99
104.0-105.0	0.00	111.65	0.00	99.99	151.0-152.0	0.00	111.65	0.00	99.99
105.0-106.0	0.00	111.65	0.00	99.99	152.0-153.0	0.00	111.65	0.00	99.99
106.0-107.0	0.00	111.65	0.00	99.99	153.0-154.0	0.00	111.65	0.00	100.00
107.0-108.0	0.00	111.65	0.00	99.99	154.0-155.0	0.00	111.66	0.00	100.00
108.0-109.0	0.00	111.65	0.00	99.99	155.0-156.0	0.00	111.66	0.00	100.00
109.0-110.0	0.00	111.65	0.00	99.99	156.0-157.0	0.00	111.66	0.00	100.00
110.0-111.0	0.00	111.65	0.00	99.99	157.0-158.0	0.00	111.66	0.00	100.00
111.0-112.0	0.00	111.65	0.00	99.99	158.0-159.0	0.00	111.66	0.00	100.00
112.0-113.0	0.00	111.65	0.00	99.99	159.0-160.0	0.00	111.66	0.00	100.00
113.0-114.0	0.00	111.65	0.00	99.99	160.0-161.0	0.00	111.66	0.00	100.00
114.0-115.0	0.00	111.65	0.00	99.99	161.0-162.0	0.00	111.66	0.00	100.00
115.0-116.0	0.00	111.65	0.00	99.99	162.0-163.0	0.00	111.66	0.00	100.00
116.0-117.0	0.00	111.65	0.00	99.99	163.0-164.0	0.00	111.66	0.00	100.00
117.0-118.0	0.00	111.65	0.00	99.99	164.0-165.0	0.00	111.66	0.00	100.00
118.0-119.0	0.00	111.65	0.00	99.99	165.0-166.0	0.00	111.66	0.00	100.00
119.0-120.0	0.00	111.65	0.00	99.99	166.0-167.0	0.00	111.66	0.00	100.00
120.0-121.0	0.00	111.65	0.00	99.99	167.0-168.0	0.00	111.66	0.00	100.00
121.0-122.0	0.00	111.65	0.00	99.99	168.0-169.0	0.00	111.66	0.00	100.00
122.0-123.0	0.00	111.65	0.00	99.99	169.0-170.0	0.00	111.66	0.00	100.00
123.0-124.0	0.00	111.65	0.00	99.99	170.0-171.0	0.00	111.66	0.00	100.00
124.0-125.0	0.00	111.65	0.00	99.99	171.0-172.0	0.00	111.66	0.00	100.00
125.0-126.0	0.00	111.65	0.00	99.99	172.0-173.0	0.00	111.66	0.00	100.00
126.0-127.0	0.00	111.65	0.00	99.99	173.0-174.0	0.00	111.66	0.00	100.00
127.0-128.0	0.00	111.65	0.00	99.99	174.0-175.0	0.00	111.66	0.00	100.00
128.0-129.0	0.00	111.65	0.00	99.99	175.0-176.0	0.00	111.66	0.00	100.00
129.0-130.0	0.00	111.65	0.00	99.99	176.0-177.0	0.00	111.66	0.00	100.00
130.0-131.0	0.00	111.65	0.00	99.99	177.0-178.0	0.00	111.66	0.00	100.00
131.0-132.0	0.00	111.65	0.00	99.99	178.0-179.0	0.00	111.66	0.00	100.00
132.0-133.0	0.00	111.65	0.00	99.99	179.0-180.0	0.00	111.66	0.00	100.00
133.0-134.0	0.00	111.65	0.00	99.99					
134.0-135.0	0.00	111.65	0.00	99.99					
135.0-136.0	0.00	111.65	0.00	99.99					
136.0-137.0	0.00	111.65	0.00	99.99					
137.0-138.0	0.00	111.65	0.00	99.99					
138.0-139.0	0.00	111.65	0.00	99.99					
139.0-140.0	0.00	111.65	0.00	99.99					
140.0-141.0	0.00	111.65	0.00	99.99					

-
-
-

IES Indoor Report

Photometric Filename:AW21020-8W-C-3090-LDK-24D-AIDIming-500MA.IES

Rectangle ISO Lighting Intensity Diagram

Lum. Name: AW21020	Lum. Catalog: Downlight	Test ID:
Lamp Name: C	Lamp Catalog: COB	Test Lab: Test
Manufacture:	Test Machine:GON-2000	Test Date: 2024/01/10

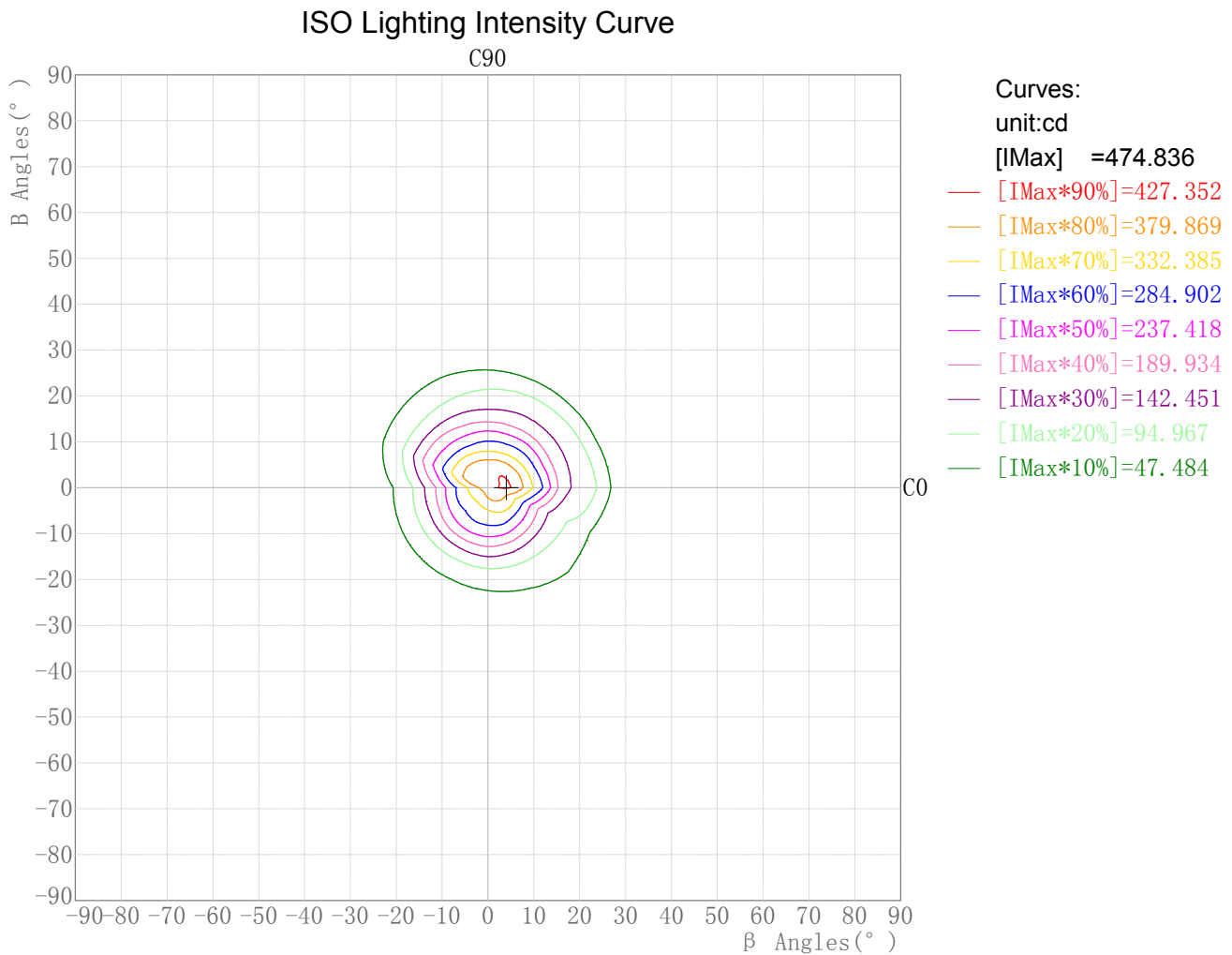

Maximum Light Intensity(cd): 474.84

Maximum Cand.@Angle: H=4.0°,V=0.0°

IES Indoor Report

Photometric Filename:AW21020-8W-C-3090-LDK-24D-AIDIming-500MA.IES

Round ISO Lighting Intensity Diagram

Lum. Name: AW21020	Lum. Catalog: Downlight	Test ID:
Lamp Name: C	Lamp Catalog: COB	Test Lab: Test
Manufacture:	Test Machine:GON-2000	Test Date: 2024/01/10

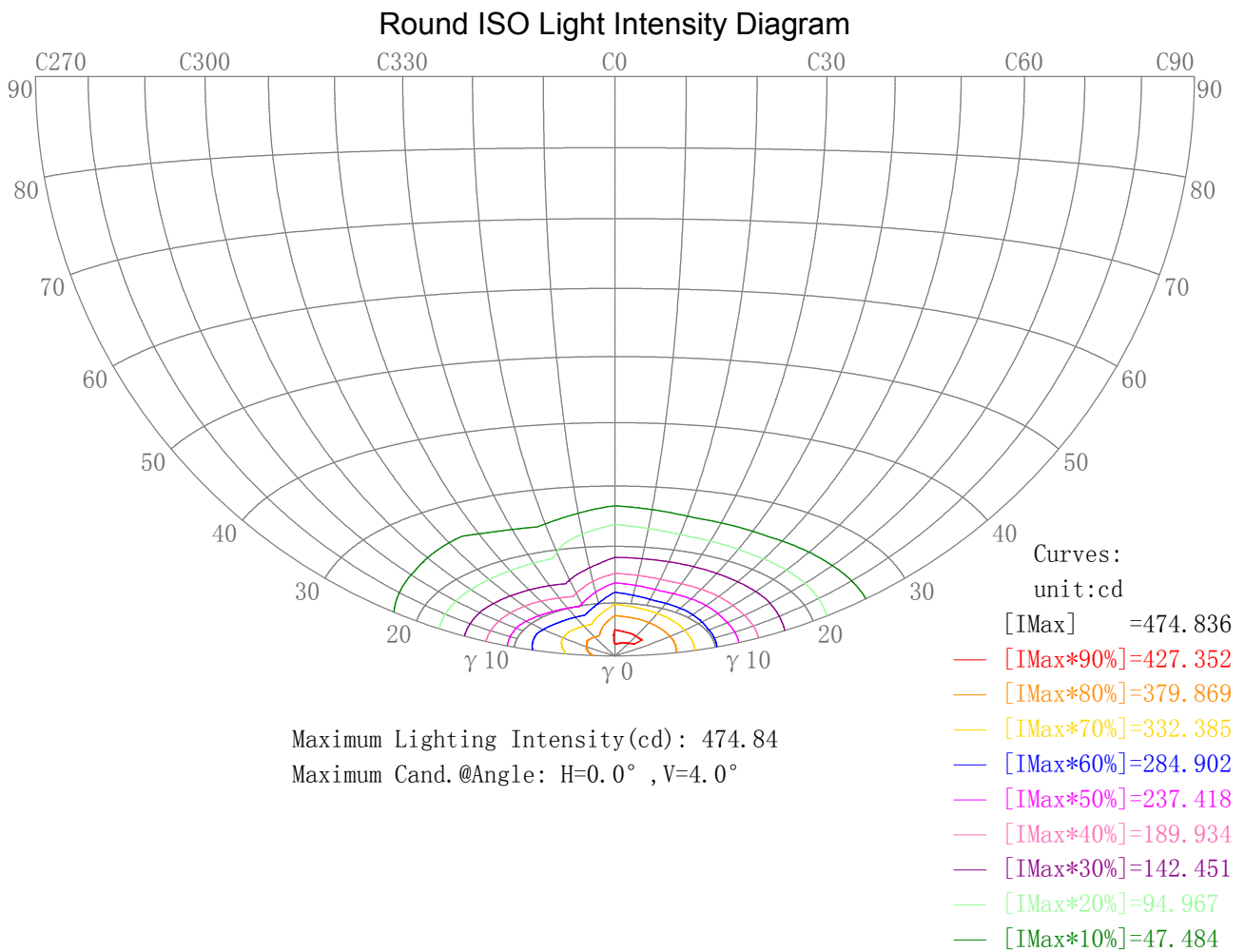

IES Indoor Report

Photometric Filename:AW21020-8W-C-3090-LDK-24D-AIDIming-500MA.IES

Plane ISO-Illuminance Diagram

Lum. Name: AW21020	Lum. Catalog: Downlight	Test ID:
Lamp Name: C	Lamp Catalog: COB	Test Lab: Test
Manufacture:	Test Machine: GON-2000	Test Date: 2024/01/10

Plane ISO-Illuminance Curve

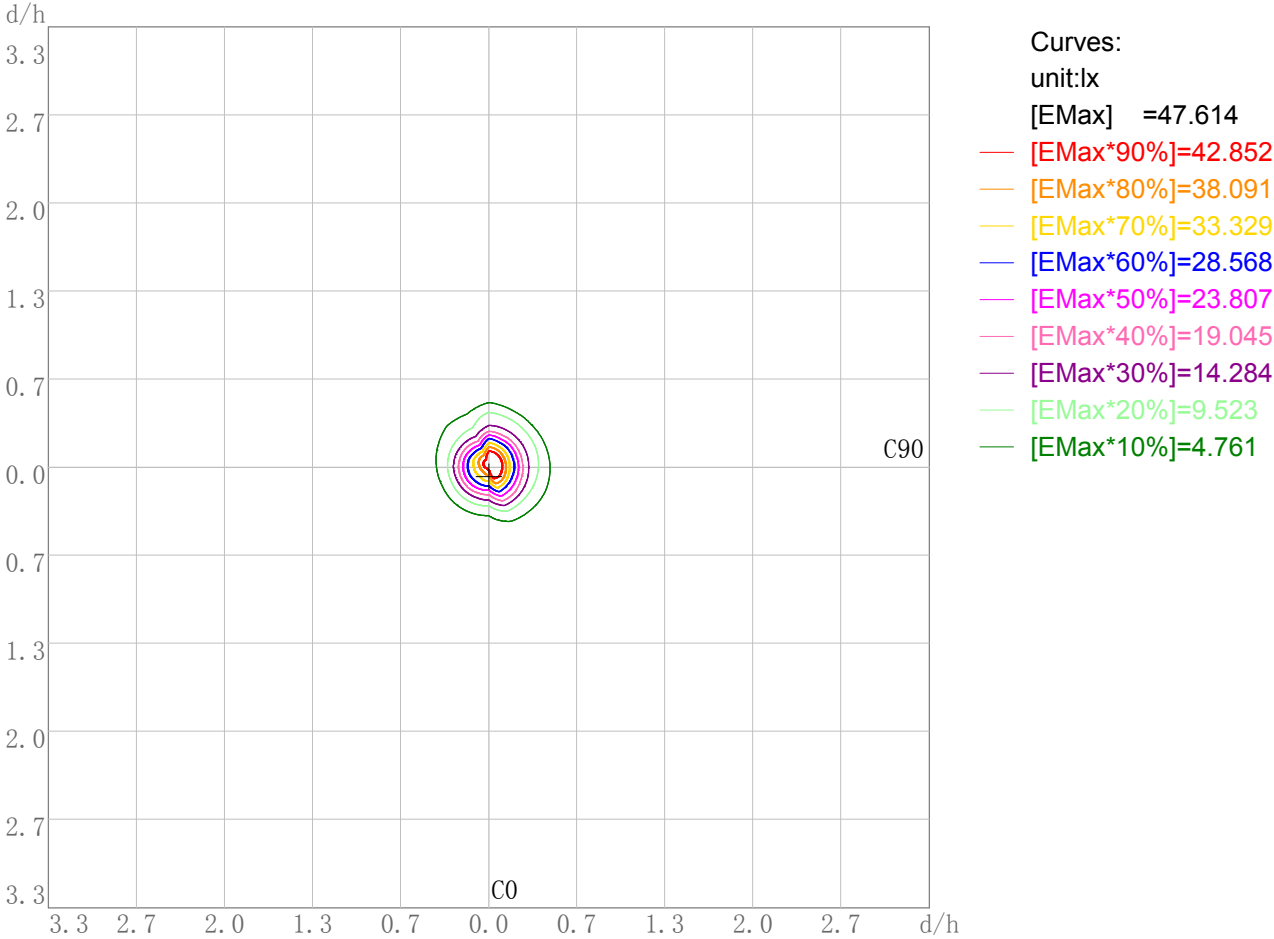

Working Plane Luminaire Mounting Height(m): 3.00
 Working Plane Maximum Illuminance(lx): 47.61
 Working Plane Maximum Illuminance Position(d/h):H0.0 V0.1

IES Indoor Report

Photometric Filename:AW21020-8W-C-3090-LDK-24D-AIDIming-500MA.IES

3D Plane ISO Illuminance Diagram

Lum. Name: AW21020	Lum. Catalog: Downlight	Test ID:
Lamp Name: C	Lamp Catalog: COB	Test Lab: Test
Manufacture:	Test Machine: GON-2000	Test Date: 2024/01/10

3D Plane Illuminance Modal

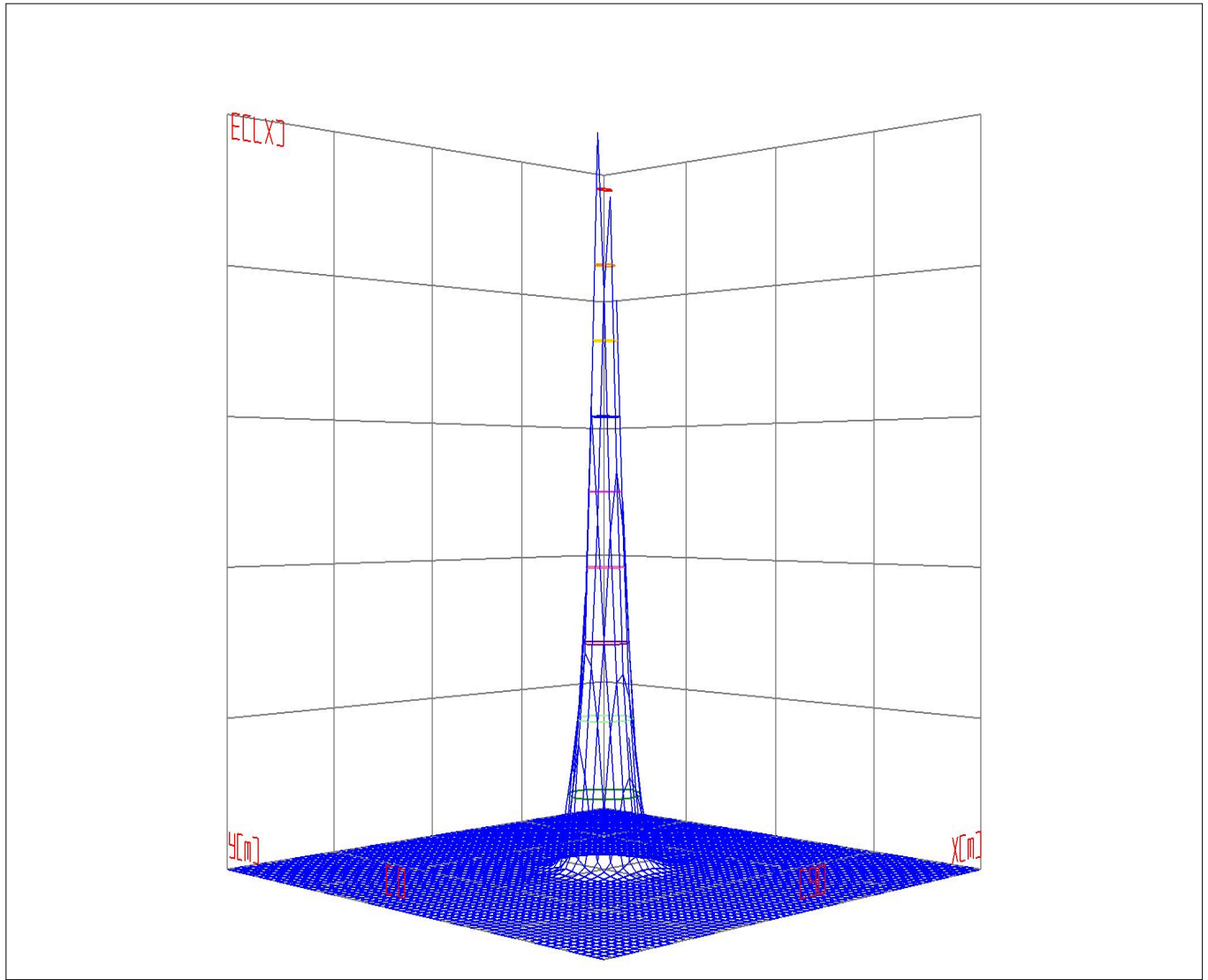

Curves: 3D Model — 90% — 80% — 70% — 60% — 50% — 40% — 30% — 20% — 10% —
View Angles(deg): 0 Height(m): 3.0 Distance(m): 10.0

IES Indoor Report

Photometric Filename:AW21020-8W-C-3090-LDK-24D-AIDIming-500MA.IES

Space ISO Illuminance Diagram

Lum. Name: AW21020	Lum. Catalog: Downlight	Test ID:
Lamp Name: C	Lamp Catalog: COB	Test Lab: Test
Manufacture:	Test Machine: GON-2000	Test Date: 2024/01/10

Space ISO Illuminance Curve

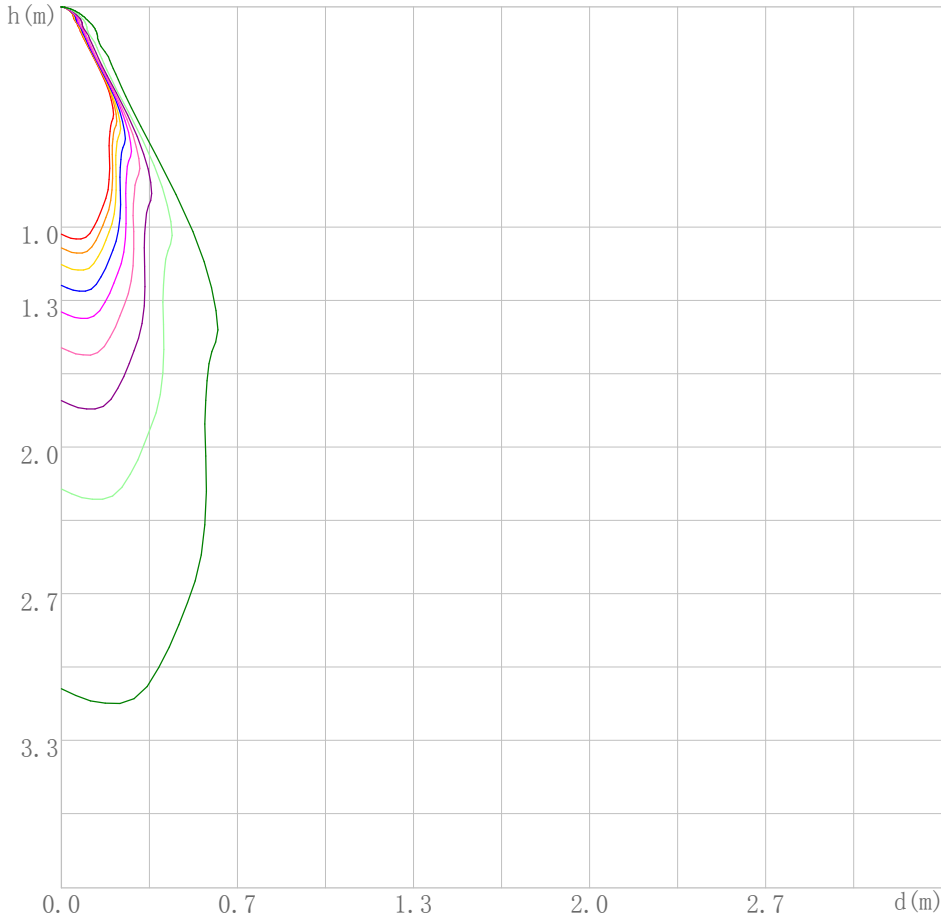

- Curves:
[Unit: lx]
[EMax] =471.374
- [EMax*90%]=424.237
 - [EMax*80%]=377.099
 - [EMax*70%]=329.962
 - [EMax*60%]=282.825
 - [EMax*50%]=235.687
 - [EMax*40%]=188.550
 - [EMax*30%]=141.412
 - [EMax*20%]=94.275
 - [EMax*10%]=47.137

Space Plane Maximum Illuminance and @Angle:471.37lx,4.0deg
Plane Maximum Lighting Intensity and @Angle:474.836cd,0deg

IES Indoor Report

Photometric Filename:AW21020-8W-C-3090-LDK-24D-AIDIming-500MA.IES

Illuminance-Distance Diagram

Lum. Name: AW21020	Lum. Catalog: Downlight	Test ID:
Lamp Name: C	Lamp Catalog: COB	Test Lab: Test
Manufacture:	Test Machine:GON-2000	Test Date: 2024/01/10

Illuminance-Distance Curve

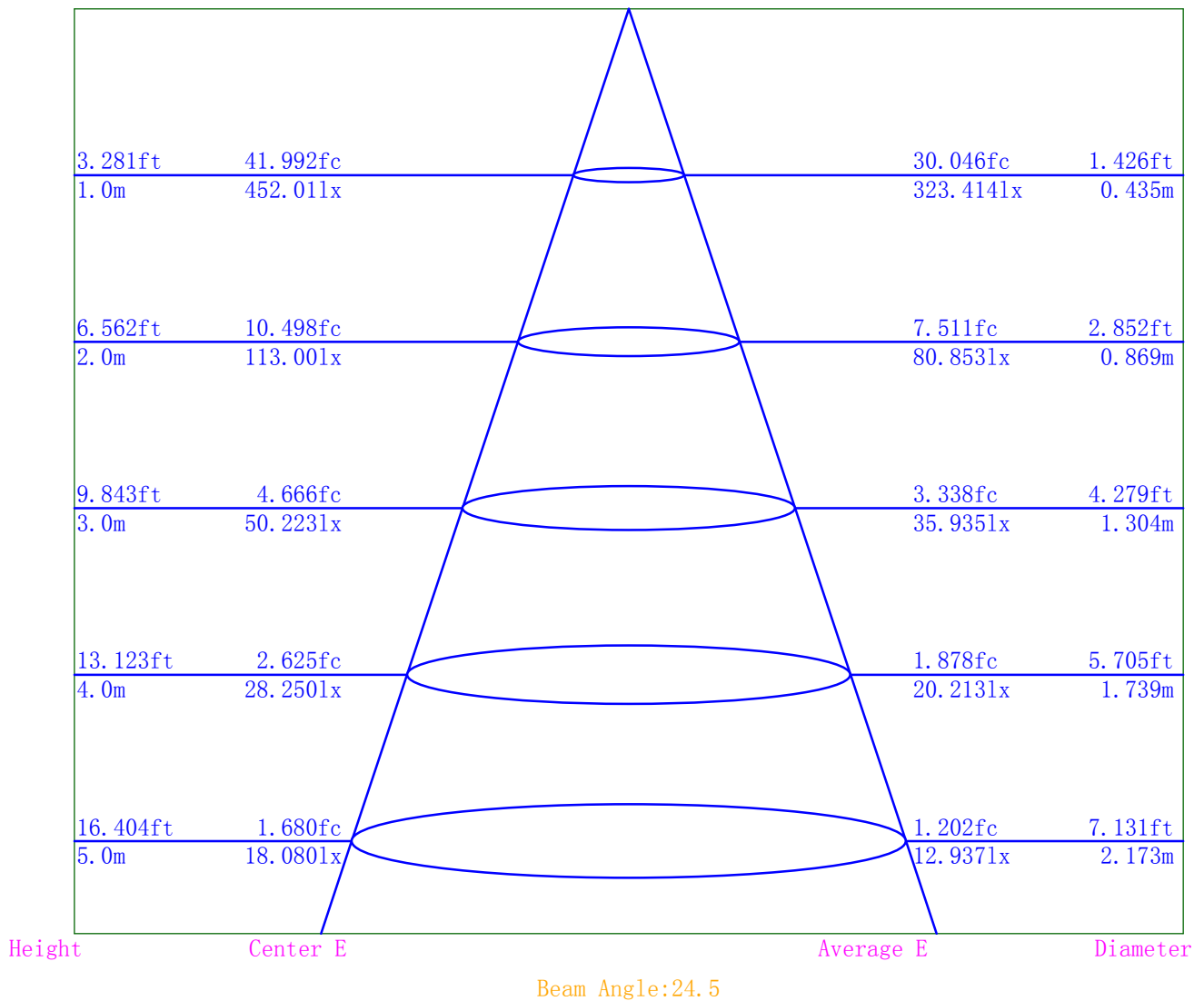

IES Indoor Report

Photometric Filename:AW21020-8W-C-3090-LDK-24D-AIDIming-500MA.IES

Indoor Luminance Limiting Curves

Lum. Name: AW21020	Lum. Catalog: Downlight	Test ID:
Lamp Name: C	Lamp Catalog: COB	Test Lab: Test
Manufacture:	Test Machine:GON-2000	Test Date: 2024/01/10

Glare Grade Table

GI	Quality	Using Illuminance							
		a	b	c	d	e	f	g	h
1.15	A	2000	1000	500	<=300				
1.5	B		2000	1000	500	<=300			
1.85	C			2000	1000	500	<=300		
2.2	D				2000	1000	500	<=300	
2.55	E	a				2000	1000	500	<=300
			b	c	d	e	f	g	h

Luminance Table

Gama (deg)	45	50	55	60	65	70	75	80	85
C0	3901	3649	3240	2375	1964	1445	1025	384	0
C90	2709	2377	1760	1197	596	0	0	0	0

Luminance Limiting Curve

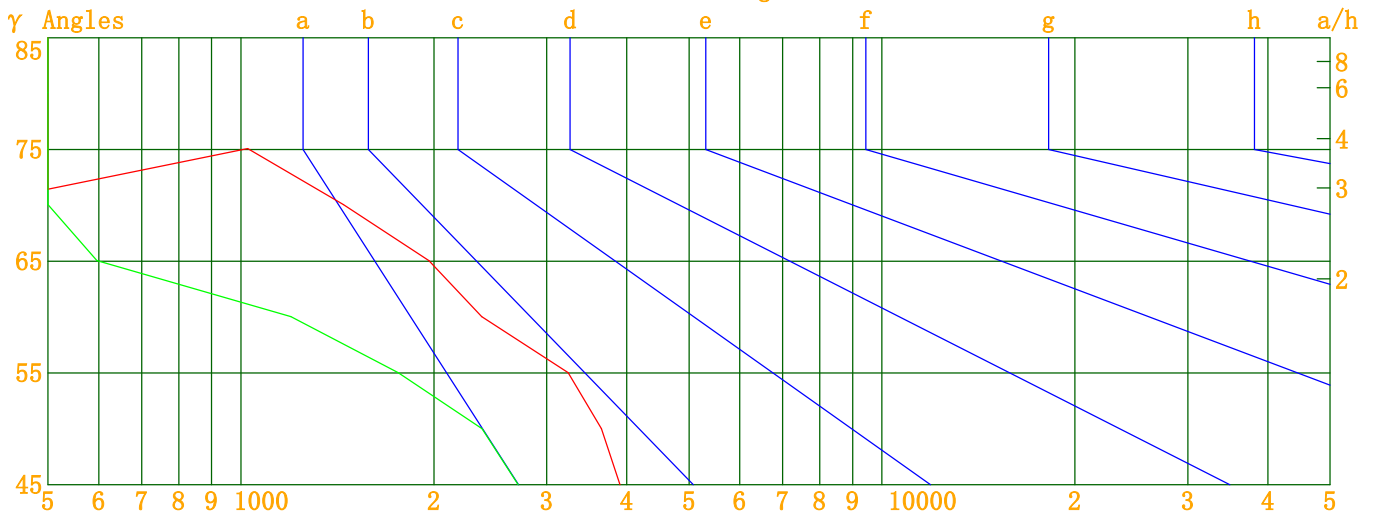

Luminous Size: Length(m)=-0.034 Width(m)=-0.034 Height(m)=0.000 Area(m^2)=0.000908
 Luminous Type: Without Luminous Side
 Luminous Curves: C0-C180 Color: — C90-C270 Color: —

IES Indoor Report

Photometric Filename: AW21020-8W-C-3090-LDK-24D-AIDIming-500MA.IES

Indoor Budgetary Estimate Table

Lum. Name: AW21020	Lum. Catalog: Downlight	Test ID:
Lamp Name: C	Lamp Catalog: COB	Test Lab: Test
Manufacture:	Test Machine: GON-2000	Test Date: 2024/01/10

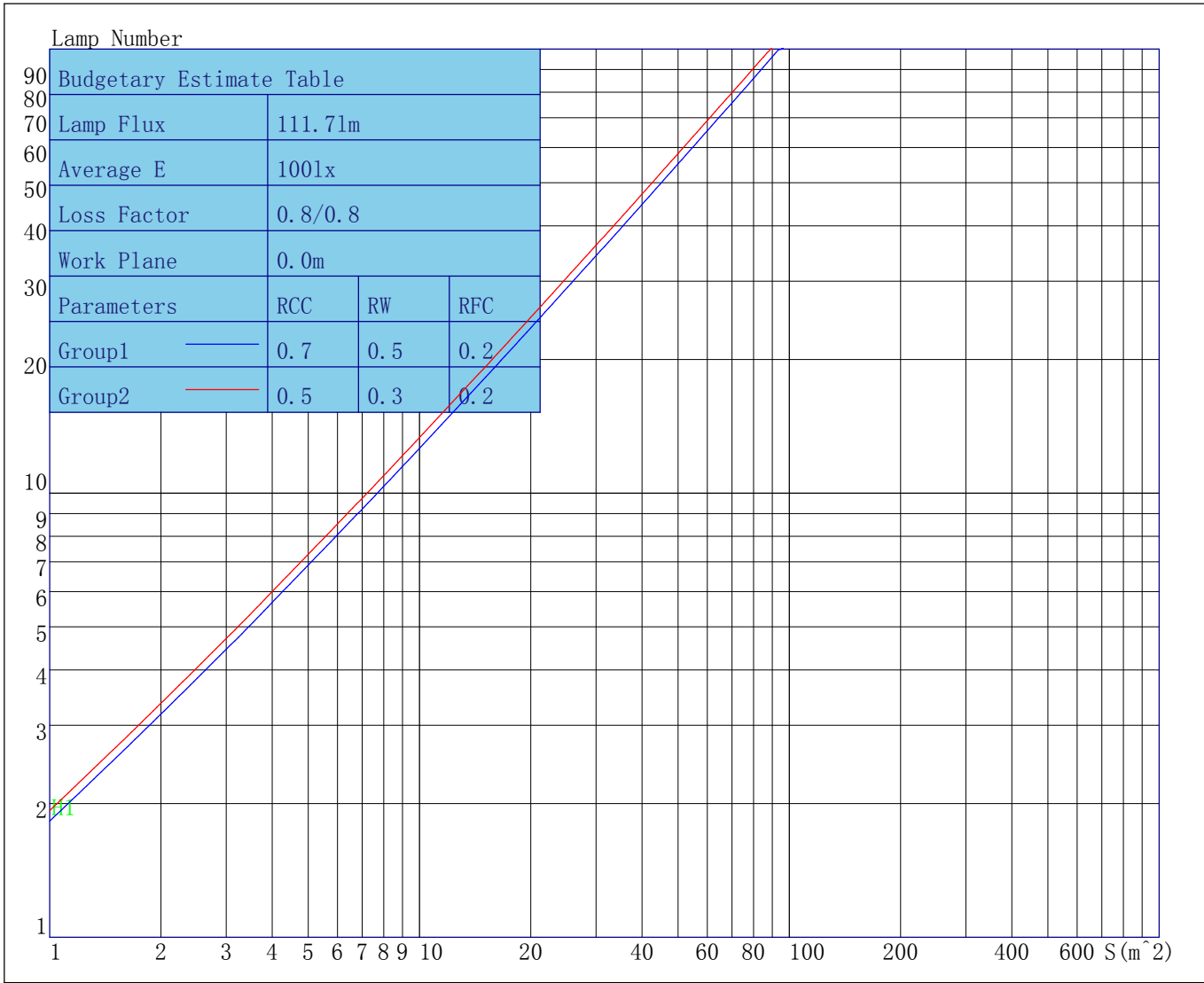

Parameters1: Rhocc = 0.7 Rhow = 0.5 Rhofc = 0.2 LLF = 0.8
 Parameters2: Rhocc = 0.5 Rhow = 0.3 Rhofc = 0.2 LLF = 0.8
 Average Illuminance(lx): 100 Cavity Height: H1(m) = 2

IES Indoor Report

Photometric Filename:AW21020-8W-C-3090-LDK-24D-AIDIming-500MA.IES

Indoor Coefficient of Utilization Table

Lum. Name: AW21020	Lum. Catalog: Downlight	Test ID:
Lamp Name: C	Lamp Catalog: COB	Test Lab: Test
Manufacture:	Test Machine:GON-2000	Test Date: 2024/01/10

Coefficients of Utilization - Zonal Cavity Method																		
Coef.	Effective Floor Cavity Reflectance RFC=0.20																	
RhoCC (%)	80				70				50			30			10			0
RhoW (%)	70	50	30	10	70	50	30	10	50	30	10	50	30	10	50	30	10	0
RCR	Coefficient of Utilization(%)																	
0	119	119	119	119	116	116	116	116	111	111	111	106	106	106	102	102	102	100
1	115	113	111	109	113	111	109	107	107	105	104	103	102	101	100	99	98	96
2	111	107	104	102	109	106	103	100	102	100	98	100	98	96	97	96	94	93
3	107	102	99	96	105	101	98	95	99	96	94	96	94	92	94	92	91	89
4	104	98	94	91	102	97	93	90	95	92	89	93	91	88	92	89	88	86
5	100	94	90	87	99	94	90	87	92	89	86	90	87	85	89	87	84	83
6	97	91	87	84	96	90	86	83	89	85	83	88	85	82	86	84	82	81
7	94	88	83	80	93	87	83	80	86	82	80	85	82	79	84	81	79	78
8	92	85	81	78	91	84	80	77	83	80	77	83	79	77	82	79	77	76
9	89	82	78	75	88	82	78	75	81	77	75	80	77	75	80	77	74	73
10	87	80	76	73	86	79	75	73	79	75	73	78	75	72	77	74	72	71

IES Indoor Report

Photometric Filename:AW21020-8W-C-3090-LDK-24D-AIDIming-500MA.IES

Unified Glare Rating Table

Lum. Name: AW21020	Lum. Catalog: Downlight	Test ID:
Lamp Name: C	Lamp Catalog: COB	Test Lab: Test
Manufacture:	Test Machine:GON-2000	Test Date: 2024/01/10

Unified Glare Rating Table

Ceiling RCC	0.70	0.70	0.50	0.50	0.30	0.70	0.70	0.50	0.50	0.30	
Wall RW	0.50	0.30	0.50	0.30	0.30	0.50	0.30	0.50	0.30	0.30	
Floor RFC	0.20	0.20	0.20	0.20	0.20	0.20	0.20	0.20	0.20	0.20	
Room Size	Vewed crosswise					Vewed endwise					
X=2H	Y=2H	6.5	7.4	6.8	7.7	8.0	6.8	7.7	7.1	8.0	8.3
	Y=3H	6.8	7.6	7.2	7.9	8.3	6.6	7.4	7.0	7.8	8.1
	Y=4H	6.8	7.5	7.2	7.9	8.3	6.5	7.3	6.9	7.6	8.0
	Y=6H	6.7	7.4	7.1	7.8	8.2	6.4	7.1	6.8	7.4	7.8
	Y=8H	6.7	7.3	7.1	7.7	8.1	6.3	7.0	6.8	7.4	7.8
	Y=12H	6.6	7.2	7.0	7.6	8.0	6.3	6.9	6.7	7.3	7.7
X=4H	Y=2H	6.2	7.0	6.6	7.3	7.7	6.7	7.4	7.1	7.8	8.2
	Y=3H	6.5	7.1	7.0	7.6	8.0	6.5	7.1	7.0	7.6	8.0
	Y=4H	6.5	7.1	7.0	7.5	8.0	6.4	6.9	6.8	7.4	7.8
	Y=6H	6.5	6.9	6.9	7.4	7.9	6.3	6.8	6.8	7.2	7.7
	Y=8H	6.4	6.8	6.9	7.3	7.7	6.2	6.6	6.7	7.1	7.6
	Y=12H	6.3	6.7	6.8	7.2	7.7	6.1	6.5	6.6	7.0	7.5
X=8H	Y=4H	6.3	6.8	6.8	7.2	7.7	6.2	6.6	6.7	7.1	7.6
	Y=6H	6.3	6.6	6.8	7.1	7.6	6.1	6.4	6.6	6.9	7.4
	Y=8H	6.2	6.5	6.7	7.0	7.5	6.0	6.3	6.5	6.8	7.3
	Y=12H	6.1	6.4	6.6	6.9	7.5	6.0	6.2	6.5	6.7	7.3
X=12H	Y=4H	6.3	6.6	6.8	7.1	7.6	6.1	6.5	6.6	7.0	7.5
	Y=6H	6.2	6.5	6.7	7.0	7.5	6.0	6.3	6.6	6.8	7.3
	Y=8H	6.1	6.4	6.6	6.9	7.5	6.0	6.2	6.5	6.7	7.3
Variations with the objverer position at spacings											
S=1.0H	1.7/-2.8					0.0/0.0					
S=1.5H	3.5/-3.8					0.0/0.0					
S=2.0H	5.8/-7.3					6.9/0.0					
Reduced UGR Table:											
Nordic Standard Table:	BKO					BKO					
Correction Value	0.4					0.2					

o the CIE Pub. 117, data has been corrected, refers to the lamp's lumens 8.2flm.

-
-
-

IES Indoor Report

Photometric Filename:AW21020-8W-C-3090-LDK-24D-AIDIming-500MA.IES

Candela Tabulation

V/H	C0.0	C22.5	C45.0	C67.5	C90.0	C112.5	C135.0	C157.5	C180.0	C202.5	C225.0	C247.5
γ 0.0	452.01	452.01	452.01	452.01	452.01	452.01	452.01	452.01	452.01	452.01	452.01	452.01
γ 1.0	460.91	457.78	457.38	457.47	460.42	463.86	464.49	465.53	435.14	426.64	424.28	427.21
γ 2.0	469.06	466.45	465.11	463.68	463.27	463.44	462.95	462.72	417.34	406.16	403.29	409.38
γ 3.0	473.01	472.02	469.71	466.44	462.75	460.30	457.63	455.76	396.47	385.50	382.47	388.18
γ 4.0	474.84	473.87	469.73	464.20	457.48	454.45	450.30	446.13	375.10	367.29	362.88	367.60
γ 5.0	470.29	466.94	459.56	451.49	442.59	443.08	440.67	433.41	353.92	351.32	345.53	350.87
γ 6.0	456.16	450.27	439.43	428.80	419.08	423.69	426.84	418.18	333.08	335.51	329.03	338.46
γ 7.0	434.01	426.95	411.58	398.77	391.59	398.11	407.01	399.78	312.70	316.85	313.92	325.41
γ 8.0	410.40	399.13	382.28	368.23	363.48	368.73	380.94	378.89	290.85	295.36	298.33	310.19
γ 9.0	384.96	370.09	355.67	342.34	338.72	338.55	351.93	356.62	266.34	273.05	280.43	291.27
γ 10.0	360.93	342.23	331.66	319.67	316.69	312.44	323.11	332.94	241.02	249.25	260.16	270.29
γ 11.0	338.45	314.78	308.33	296.51	294.87	290.04	296.39	307.81	216.41	223.35	238.75	246.82
γ 12.0	312.04	286.84	282.55	271.04	270.82	268.72	273.71	283.72	194.40	198.00	212.82	220.38
γ 13.0	281.70	257.33	254.36	243.96	243.83	245.35	254.33	261.88	173.97	174.54	185.83	193.92
γ 14.0	249.53	227.75	225.78	217.01	217.16	220.56	235.13	241.11	152.84	152.79	160.75	168.81
γ 15.0	217.53	202.53	200.20	193.21	193.96	197.82	213.71	218.50	130.76	132.94	138.90	145.69
γ 16.0	190.46	182.49	178.47	174.51	174.45	178.02	189.79	195.11	110.64	114.87	119.64	124.59
γ 17.0	171.91	166.36	162.44	160.96	157.36	160.45	165.24	170.86	93.61	98.90	102.72	105.33
γ 18.0	157.90	155.93	153.51	151.50	142.96	143.32	142.77	147.77	78.43	84.26	87.26	88.71
γ 19.0	146.35	149.52	144.87	140.50	131.76	126.74	123.79	126.72	66.71	70.39	74.01	75.37
γ 20.0	139.27	141.52	132.69	128.47	121.36	113.66	108.38	108.20	57.35	59.28	63.06	65.18
γ 21.0	134.26	129.11	119.09	115.37	109.85	102.65	95.55	92.74	49.55	50.65	53.07	55.61
γ 22.0	127.24	113.77	104.02	101.65	97.87	93.06	84.27	80.22	42.62	43.55	45.24	47.95
γ 23.0	114.96	97.08	87.39	87.65	86.33	84.00	74.31	69.27	36.34	37.77	39.29	41.61
γ 24.0	100.45	79.92	70.52	72.80	74.55	72.67	65.25	59.64	30.91	32.68	34.22	35.57
γ 25.0	84.85	62.76	54.56	56.62	61.62	62.05	56.33	51.06	26.41	28.20	29.37	29.92
γ 26.0	67.53	45.58	38.74	41.05	47.59	51.99	48.12	43.74	22.61	24.07	24.91	25.02
γ 27.0	48.32	30.45	25.77	28.03	34.11	41.10	40.70	37.88	19.30	20.48	21.13	21.18
γ 28.0	31.41	20.46	17.91	19.19	23.62	30.37	33.92	32.97	16.44	17.55	18.06	18.21
γ 29.0	20.68	15.01	13.38	14.03	16.81	21.95	27.45	28.42	13.73	15.12	15.59	15.86
γ 30.0	15.27	11.78	10.42	10.88	12.70	16.19	21.35	23.92	11.26	12.99	13.56	13.80
γ 31.0	12.28	9.53	8.34	8.67	10.10	12.49	16.37	19.77	9.13	11.05	11.81	11.97
γ 32.0	10.27	7.87	6.89	7.13	8.29	10.18	12.87	16.10	7.64	9.25	10.19	10.07
γ 33.0	8.80	6.70	5.91	6.02	6.97	8.61	10.55	13.15	6.48	7.69	8.58	8.39
γ 34.0	7.68	5.83	5.15	5.20	6.03	7.38	8.96	11.01	5.54	6.50	7.17	7.00
γ 35.0	6.76	5.15	4.54	4.57	5.28	6.40	7.74	9.47	4.71	5.54	6.14	5.94
γ 36.0	6.06	4.60	4.02	4.05	4.69	5.64	6.79	8.29	4.02	4.74	5.29	5.18
γ 37.0	5.48	4.05	3.46	3.47	4.14	4.99	6.00	7.34	3.35	4.02	4.56	4.49
γ 38.0	4.97	3.21	2.74	2.79	3.44	4.44	5.33	6.53	2.67	3.35	3.87	3.90
γ 39.0	4.16	2.56	2.41	2.42	2.73	3.89	4.76	5.81	2.11	2.71	3.24	3.33
γ 40.0	3.38	2.29	2.17	2.17	2.37	3.00	4.24	5.17	1.60	2.10	2.64	2.79
γ 41.0	3.03	2.09	2.00	2.01	2.12	2.48	3.68	4.59	1.12	1.58	2.09	2.24
γ 42.0	2.83	1.95	1.92	1.92	1.95	2.22	2.97	4.09	0.65	1.11	1.61	1.74
γ 43.0	2.68	1.91	1.85	1.85	1.87	1.98	2.46	3.55	0.00	0.66	1.16	1.30
γ 44.0	2.55	1.93	1.79	1.78	1.80	1.84	2.17	2.94	0.00	0.09	0.74	0.81
γ 45.0	2.50	1.89	1.74	1.73	1.74	1.76	2.00	2.37	0.00	0.00	0.04	0.13
γ 46.0	2.45	1.81	1.70	1.69	1.66	1.71	1.87	2.12	0.00	0.00	0.00	0.00

-
-
-

IES Indoor Report

Photometric Filename:AW21020-8W-C-3090-LDK-24D-AIDIming-500MA.IES

Candela Tabulation - (Cont.)

V/H	C0.0	C22.5	C45.0	C67.5	C90.0	C112.5	C135.0	C157.5	C180.0	C202.5	C225.0	C247.5
γ 47.0	2.37	1.75	1.64	1.60	1.61	1.60	1.77	1.97	0.00	0.00	0.00	0.00
γ 48.0	2.30	1.71	1.57	1.54	1.54	1.57	1.69	1.83	0.00	0.00	0.00	0.00
γ 49.0	2.23	1.66	1.49	1.48	1.45	1.48	1.60	1.77	0.00	0.00	0.00	0.00
γ 50.0	2.13	1.59	1.43	1.37	1.39	1.40	1.53	1.71	0.00	0.00	0.00	0.00
γ 51.0	2.06	1.52	1.37	1.32	1.33	1.37	1.46	1.66	0.00	0.00	0.00	0.00
γ 52.0	1.98	1.44	1.28	1.27	1.25	1.30	1.37	1.59	0.00	0.00	0.00	0.00
γ 53.0	1.89	1.34	1.18	1.15	1.17	1.25	1.31	1.47	0.00	0.00	0.00	0.00
γ 54.0	1.77	1.20	0.99	0.99	1.06	1.18	1.24	1.40	0.00	0.00	0.00	0.00
γ 55.0	1.69	1.05	0.89	0.86	0.92	1.05	1.16	1.33	0.00	0.00	0.00	0.00
γ 56.0	1.53	0.94	0.82	0.79	0.79	0.98	1.07	1.23	0.00	0.00	0.00	0.00
γ 57.0	1.38	0.85	0.75	0.73	0.73	0.84	1.01	1.17	0.00	0.00	0.00	0.00
γ 58.0	1.26	0.78	0.66	0.70	0.67	0.72	0.92	1.09	0.00	0.00	0.00	0.00
γ 59.0	1.16	0.71	0.59	0.62	0.60	0.63	0.79	1.01	0.00	0.00	0.00	0.00
γ 60.0	1.08	0.66	0.52	0.56	0.54	0.57	0.66	0.93	0.00	0.00	0.00	0.00
γ 61.0	1.02	0.60	0.50	0.50	0.47	0.51	0.58	0.85	0.00	0.00	0.00	0.00
γ 62.0	0.94	0.54	0.42	0.46	0.39	0.44	0.51	0.72	0.00	0.00	0.00	0.00
γ 63.0	0.87	0.47	0.35	0.40	0.34	0.40	0.47	0.54	0.00	0.00	0.00	0.00
γ 64.0	0.81	0.40	0.31	0.36	0.28	0.34	0.40	0.45	0.00	0.00	0.00	0.00
γ 65.0	0.75	0.36	0.24	0.28	0.23	0.28	0.33	0.39	0.00	0.00	0.00	0.00
γ 66.0	0.69	0.31	0.21	0.22	0.16	0.24	0.28	0.34	0.00	0.00	0.00	0.00
γ 67.0	0.63	0.24	0.14	0.14	0.13	0.19	0.21	0.26	0.00	0.00	0.00	0.00
γ 68.0	0.54	0.17	0.08	0.09	0.07	0.12	0.19	0.20	0.00	0.00	0.00	0.00
γ 69.0	0.50	0.13	0.02	0.05	0.02	0.11	0.16	0.16	0.00	0.00	0.00	0.00
γ 70.0	0.45	0.08	0.00	0.01	0.00	0.02	0.09	0.13	0.00	0.00	0.00	0.00
γ 71.0	0.43	0.02	0.00	0.00	0.00	0.00	0.02	0.08	0.00	0.00	0.00	0.00
γ 72.0	0.35	0.00	0.00	0.00	0.00	0.00	0.00	0.02	0.00	0.00	0.00	0.00
γ 73.0	0.28	0.00	0.00	0.00	0.00	0.00	0.00	0.00	0.00	0.00	0.00	0.00
γ 74.0	0.23	0.00	0.00	0.00	0.00	0.00	0.00	0.00	0.00	0.00	0.00	0.00
γ 75.0	0.24	0.00	0.00	0.00	0.00	0.00	0.00	0.00	0.00	0.00	0.00	0.00
γ 76.0	0.17	0.00	0.00	0.00	0.00	0.00	0.00	0.00	0.00	0.00	0.00	0.00
γ 77.0	0.12	0.00	0.00	0.00	0.00	0.00	0.00	0.00	0.00	0.00	0.00	0.00
γ 78.0	0.08	0.00	0.00	0.00	0.00	0.00	0.00	0.00	0.00	0.00	0.00	0.00
γ 79.0	0.02	0.00	0.00	0.00	0.00	0.00	0.00	0.00	0.00	0.00	0.00	0.00
γ 80.0	0.06	0.00	0.00	0.00	0.00	0.00	0.00	0.00	0.00	0.00	0.00	0.00
γ 81.0	0.05	0.00	0.00	0.00	0.00	0.00	0.00	0.00	0.00	0.00	0.00	0.00
γ 82.0	0.00	0.00	0.00	0.00	0.00	0.00	0.00	0.00	0.00	0.00	0.00	0.00
γ 83.0	0.00	0.00	0.00	0.00	0.00	0.00	0.00	0.00	0.00	0.00	0.00	0.00
γ 84.0	0.00	0.00	0.00	0.00	0.00	0.00	0.00	0.00	0.00	0.00	0.00	0.00
γ 85.0	0.00	0.00	0.00	0.00	0.00	0.00	0.00	0.00	0.00	0.00	0.00	0.00
γ 86.0	0.00	0.00	0.00	0.00	0.00	0.00	0.00	0.00	0.00	0.00	0.00	0.00
γ 87.0	0.00	0.00	0.00	0.00	0.00	0.00	0.00	0.00	0.00	0.00	0.00	0.00
γ 88.0	0.00	0.00	0.00	0.00	0.00	0.00	0.00	0.00	0.00	0.00	0.00	0.00
γ 89.0	0.00	0.00	0.00	0.00	0.00	0.00	0.00	0.00	0.00	0.00	0.00	0.00
γ 90.0	0.00	0.00	0.00	0.00	0.00	0.00	0.00	0.00	0.00	0.00	0.00	0.00
γ 91.0	0.00	0.00	0.00	0.00	0.00	0.00	0.00	0.00	0.00	0.00	0.00	0.00
γ 92.0	0.00	0.00	0.00	0.00	0.00	0.00	0.00	0.00	0.00	0.00	0.00	0.00
γ 93.0	0.00	0.00	0.00	0.00	0.00	0.00	0.00	0.00	0.00	0.00	0.00	0.00

-
-
-

IES Indoor Report

Photometric Filename:AW21020-8W-C-3090-LDK-24D-AIDIming-500MA.IES

Candela Tabulation - (Cont.)

V/H	C0.0	C22.5	C45.0	C67.5	C90.0	C112.5	C135.0	C157.5	C180.0	C202.5	C225.0	C247.5
γ 141.0	0.00	0.00	0.00	0.00	0.00	0.00	0.00	0.00	0.00	0.00	0.00	0.00
γ 142.0	0.00	0.00	0.00	0.00	0.00	0.00	0.00	0.00	0.00	0.00	0.00	0.00
γ 143.0	0.00	0.00	0.00	0.00	0.00	0.00	0.00	0.00	0.00	0.00	0.00	0.00
γ 144.0	0.00	0.00	0.00	0.00	0.00	0.00	0.00	0.00	0.00	0.00	0.00	0.00
γ 145.0	0.00	0.00	0.00	0.00	0.00	0.00	0.00	0.00	0.00	0.00	0.00	0.00
γ 146.0	0.00	0.00	0.00	0.00	0.00	0.00	0.00	0.00	0.00	0.00	0.00	0.00
γ 147.0	0.00	0.00	0.00	0.00	0.00	0.00	0.00	0.00	0.00	0.00	0.00	0.00
γ 148.0	0.00	0.00	0.00	0.00	0.00	0.00	0.00	0.00	0.00	0.00	0.00	0.00
γ 149.0	0.00	0.00	0.00	0.00	0.00	0.00	0.00	0.00	0.00	0.00	0.00	0.00
γ 150.0	0.00	0.00	0.00	0.00	0.00	0.00	0.00	0.00	0.00	0.00	0.00	0.00
γ 151.0	0.01	0.00	0.00	0.00	0.00	0.00	0.00	0.00	0.00	0.00	0.00	0.00
γ 152.0	0.05	0.00	0.00	0.00	0.00	0.00	0.00	0.00	0.00	0.00	0.00	0.00
γ 153.0	0.13	0.00	0.00	0.00	0.00	0.00	0.00	0.00	0.00	0.00	0.00	0.00
γ 154.0	0.19	0.00	0.00	0.00	0.00	0.00	0.00	0.00	0.00	0.00	0.00	0.00
γ 155.0	0.25	0.00	0.00	0.00	0.00	0.00	0.00	0.00	0.00	0.00	0.00	0.00
γ 156.0	0.31	0.00	0.00	0.00	0.00	0.00	0.00	0.00	0.07	0.00	0.00	0.00
γ 157.0	0.32	0.00	0.00	0.00	0.00	0.00	0.00	0.00	0.13	0.00	0.00	0.00
γ 158.0	0.36	0.00	0.00	0.00	0.00	0.00	0.00	0.00	0.00	0.00	0.00	0.00
γ 159.0	0.29	0.00	0.00	0.00	0.00	0.00	0.00	0.00	0.00	0.00	0.00	0.00
γ 160.0	0.02	0.00	0.00	0.00	0.00	0.00	0.00	0.00	0.00	0.00	0.00	0.00
γ 161.0	0.00	0.00	0.00	0.00	0.00	0.00	0.00	0.00	0.00	0.00	0.00	0.00
γ 162.0	0.00	0.00	0.00	0.00	0.00	0.00	0.00	0.00	0.00	0.00	0.00	0.00
γ 163.0	0.00	0.00	0.00	0.00	0.00	0.00	0.00	0.00	0.00	0.00	0.00	0.00
γ 164.0	0.00	0.00	0.00	0.00	0.00	0.00	0.00	0.00	0.00	0.00	0.00	0.00
γ 165.0	0.00	0.00	0.00	0.00	0.00	0.00	0.00	0.00	0.00	0.00	0.00	0.00
γ 166.0	0.00	0.00	0.00	0.00	0.00	0.00	0.00	0.00	0.00	0.00	0.00	0.00
γ 167.0	0.00	0.00	0.00	0.00	0.00	0.00	0.00	0.00	0.00	0.00	0.00	0.00
γ 168.0	0.00	0.00	0.00	0.00	0.00	0.00	0.00	0.00	0.00	0.00	0.00	0.00
γ 169.0	0.00	0.00	0.00	0.00	0.00	0.00	0.00	0.00	0.00	0.00	0.00	0.00
γ 170.0	0.00	0.00	0.00	0.00	0.00	0.00	0.00	0.00	0.00	0.00	0.00	0.00
γ 171.0	0.00	0.00	0.00	0.00	0.00	0.00	0.00	0.00	0.00	0.00	0.00	0.00
γ 172.0	0.00	0.00	0.00	0.00	0.00	0.00	0.00	0.00	0.00	0.00	0.00	0.00
γ 173.0	0.00	0.00	0.00	0.00	0.00	0.00	0.00	0.00	0.00	0.00	0.00	0.00
γ 174.0	0.00	0.00	0.00	0.00	0.00	0.00	0.00	0.00	0.00	0.00	0.00	0.00
γ 175.0	0.00	0.00	0.00	0.00	0.00	0.00	0.00	0.00	0.00	0.00	0.00	0.00
γ 176.0	0.00	0.00	0.00	0.00	0.00	0.00	0.00	0.00	0.00	0.00	0.00	0.00
γ 177.0	0.00	0.00	0.00	0.00	0.00	0.00	0.00	0.00	0.00	0.00	0.00	0.00
γ 178.0	0.00	0.00	0.00	0.00	0.00	0.00	0.00	0.00	0.00	0.00	0.00	0.00
γ 179.0	0.00	0.00	0.00	0.00	0.00	0.00	0.00	0.00	0.00	0.00	0.00	0.00
γ 180.0	0.00	0.00	0.00	0.00	0.00	0.00	0.00	0.00	0.00	0.00	0.00	0.00
V/H	C270.0	C292.5	C315.0	C337.5								
γ 0.0	452.01	452.01	452.01	452.01								
γ 1.0	437.77	449.51	453.56	457.47								
γ 2.0	421.98	436.08	443.63	448.85								
γ 3.0	403.00	419.36	431.70	437.26								
γ 4.0	381.95	399.55	417.40	421.43								
γ 5.0	362.87	379.51	398.99	400.93								

-
-
-

IES Indoor Report

Photometric Filename:AW21020-8W-C-3090-LDK-24D-AIDIming-500MA.IES

Candela Tabulation - (Cont.)

V/H	C270. 0	C292. 5	C315. 0	C337. 5
γ 6. 0	346. 47	362. 77	375. 69	376. 74
γ 7. 0	331. 24	346. 95	348. 99	350. 20
γ 8. 0	316. 06	327. 07	320. 79	320. 95
γ 9. 0	299. 10	303. 99	293. 75	289. 63
γ 10. 0	277. 98	280. 30	268. 51	258. 80
γ 11. 0	253. 67	255. 65	244. 32	230. 51
γ 12. 0	229. 25	229. 05	220. 34	203. 88
γ 13. 0	205. 18	202. 66	195. 33	179. 74
γ 14. 0	181. 40	178. 09	170. 81	159. 37
γ 15. 0	157. 45	156. 89	148. 51	142. 97
γ 16. 0	134. 46	135. 89	130. 37	129. 99
γ 17. 0	114. 83	117. 99	116. 45	119. 01
γ 18. 0	98. 52	102. 80	105. 54	109. 09
γ 19. 0	84. 52	90. 93	97. 14	102. 54
γ 20. 0	73. 04	81. 60	89. 88	98. 29
γ 21. 0	63. 68	73. 58	82. 71	92. 83
γ 22. 0	55. 41	65. 76	75. 95	82. 59
γ 23. 0	47. 59	57. 27	69. 55	69. 01
γ 24. 0	40. 35	49. 28	62. 53	54. 32
γ 25. 0	33. 81	42. 15	53. 78	37. 84
γ 26. 0	27. 96	35. 51	43. 34	23. 05
γ 27. 0	23. 28	29. 73	31. 29	13. 43
γ 28. 0	19. 61	24. 46	20. 07	8. 86
γ 29. 0	16. 57	18. 79	11. 89	6. 82
γ 30. 0	13. 78	13. 29	7. 80	5. 61
γ 31. 0	11. 17	9. 13	6. 09	4. 68
γ 32. 0	8. 93	6. 88	5. 05	3. 94
γ 33. 0	7. 18	5. 68	4. 24	3. 28
γ 34. 0	5. 98	4. 78	3. 55	2. 70
γ 35. 0	5. 13	4. 10	2. 97	2. 22
γ 36. 0	4. 45	3. 50	2. 43	1. 80
γ 37. 0	3. 85	2. 89	1. 94	1. 19
γ 38. 0	3. 29	2. 40	1. 50	0. 43
γ 39. 0	2. 73	1. 88	1. 02	0. 05
γ 40. 0	2. 19	1. 44	0. 38	0. 00
γ 41. 0	1. 71	0. 98	0. 00	0. 00
γ 42. 0	1. 26	0. 29	0. 00	0. 00
γ 43. 0	0. 73	0. 00	0. 00	0. 00
γ 44. 0	0. 06	0. 00	0. 00	0. 00
γ 45. 0	0. 00	0. 00	0. 00	0. 00
γ 46. 0	0. 00	0. 00	0. 00	0. 00
γ 47. 0	0. 00	0. 00	0. 00	0. 00
γ 48. 0	0. 00	0. 00	0. 00	0. 00
γ 49. 0	0. 00	0. 00	0. 00	0. 00
γ 50. 0	0. 00	0. 00	0. 00	0. 00
γ 51. 0	0. 00	0. 00	0. 00	0. 00
γ 52. 0	0. 00	0. 00	0. 00	0. 00

IES Indoor Report

Photometric Filename:AW21020-8W-C-3090-LDK-24D-AIDIming-500MA.IES

Candela Tabulation - (Cont.)

V/H	C270.0	C292.5	C315.0	C337.5
γ 53.0	0.00	0.00	0.00	0.00
γ 54.0	0.00	0.00	0.00	0.00
γ 55.0	0.00	0.00	0.00	0.00
γ 56.0	0.00	0.00	0.00	0.00
γ 57.0	0.00	0.00	0.00	0.00
γ 58.0	0.00	0.00	0.00	0.00
γ 59.0	0.00	0.00	0.00	0.00
γ 60.0	0.00	0.00	0.00	0.00
γ 61.0	0.00	0.00	0.00	0.00
γ 62.0	0.00	0.00	0.00	0.00
γ 63.0	0.00	0.00	0.00	0.00
γ 64.0	0.00	0.00	0.00	0.00
γ 65.0	0.00	0.00	0.00	0.00
γ 66.0	0.00	0.00	0.00	0.00
γ 67.0	0.00	0.00	0.00	0.00
γ 68.0	0.00	0.00	0.00	0.00
γ 69.0	0.00	0.00	0.00	0.00
γ 70.0	0.00	0.00	0.00	0.00
γ 71.0	0.00	0.00	0.00	0.00
γ 72.0	0.00	0.00	0.00	0.00
γ 73.0	0.00	0.00	0.00	0.00
γ 74.0	0.00	0.00	0.00	0.00
γ 75.0	0.00	0.00	0.00	0.00
γ 76.0	0.00	0.00	0.00	0.00
γ 77.0	0.00	0.00	0.00	0.00
γ 78.0	0.00	0.00	0.00	0.00
γ 79.0	0.00	0.00	0.00	0.00
γ 80.0	0.00	0.00	0.00	0.00
γ 81.0	0.00	0.00	0.00	0.00
γ 82.0	0.00	0.00	0.00	0.00
γ 83.0	0.00	0.00	0.00	0.00
γ 84.0	0.00	0.00	0.00	0.00
γ 85.0	0.00	0.00	0.00	0.00
γ 86.0	0.00	0.00	0.00	0.00
γ 87.0	0.00	0.00	0.00	0.00
γ 88.0	0.00	0.00	0.00	0.00
γ 89.0	0.00	0.00	0.00	0.00
γ 90.0	0.00	0.00	0.00	0.00
γ 91.0	0.00	0.00	0.00	0.00
γ 92.0	0.00	0.00	0.00	0.00
γ 93.0	0.00	0.00	0.00	0.00
γ 94.0	0.00	0.00	0.00	0.00
γ 95.0	0.00	0.00	0.00	0.00
γ 96.0	0.00	0.00	0.00	0.00
γ 97.0	0.00	0.00	0.00	0.00
γ 98.0	0.00	0.00	0.00	0.00
γ 99.0	0.00	0.00	0.00	0.00

-
-
-

IES Indoor Report

Photometric Filename:AW21020-8W-C-3090-LDK-24D-AIDIming-500MA.IES

Candela Tabulation - (Cont.)

V/H	C270.0	C292.5	C315.0	C337.5
γ 100.0	0.00	0.00	0.00	0.00
γ 101.0	0.00	0.00	0.00	0.00
γ 102.0	0.00	0.00	0.00	0.00
γ 103.0	0.00	0.00	0.00	0.00
γ 104.0	0.00	0.00	0.00	0.00
γ 105.0	0.00	0.00	0.00	0.00
γ 106.0	0.00	0.00	0.00	0.00
γ 107.0	0.00	0.00	0.00	0.00
γ 108.0	0.00	0.00	0.00	0.00
γ 109.0	0.00	0.00	0.00	0.00
γ 110.0	0.00	0.00	0.00	0.00
γ 111.0	0.00	0.00	0.00	0.00
γ 112.0	0.00	0.00	0.00	0.00
γ 113.0	0.00	0.00	0.00	0.00
γ 114.0	0.00	0.00	0.00	0.00
γ 115.0	0.00	0.00	0.00	0.00
γ 116.0	0.00	0.00	0.00	0.00
γ 117.0	0.00	0.00	0.00	0.00
γ 118.0	0.00	0.00	0.00	0.00
γ 119.0	0.00	0.00	0.00	0.00
γ 120.0	0.00	0.00	0.00	0.00
γ 121.0	0.00	0.00	0.00	0.00
γ 122.0	0.00	0.00	0.00	0.00
γ 123.0	0.00	0.00	0.00	0.00
γ 124.0	0.00	0.00	0.00	0.00
γ 125.0	0.00	0.00	0.00	0.00
γ 126.0	0.00	0.00	0.00	0.00
γ 127.0	0.00	0.00	0.00	0.00
γ 128.0	0.00	0.00	0.00	0.00
γ 129.0	0.00	0.00	0.00	0.00
γ 130.0	0.00	0.00	0.00	0.00
γ 131.0	0.00	0.00	0.00	0.00
γ 132.0	0.00	0.00	0.00	0.00
γ 133.0	0.00	0.00	0.00	0.00
γ 134.0	0.00	0.00	0.00	0.00
γ 135.0	0.00	0.00	0.00	0.00
γ 136.0	0.00	0.00	0.00	0.00
γ 137.0	0.00	0.00	0.00	0.00
γ 138.0	0.00	0.00	0.00	0.00
γ 139.0	0.00	0.00	0.00	0.00
γ 140.0	0.00	0.00	0.00	0.00
γ 141.0	0.00	0.00	0.00	0.00
γ 142.0	0.00	0.00	0.00	0.00
γ 143.0	0.00	0.00	0.00	0.00
γ 144.0	0.00	0.00	0.00	0.00
γ 145.0	0.00	0.00	0.00	0.00
γ 146.0	0.00	0.00	0.00	0.00

IES Indoor Report

Photometric Filename:AW21020-8W-C-3090-LDK-24D-AIDIming-500MA.IES

Candela Tabulation - (Cont.)

V/H	C270. 0	C292. 5	C315. 0	C337. 5
γ 147. 0	0. 00	0. 00	0. 00	0. 00
γ 148. 0	0. 00	0. 00	0. 00	0. 00
γ 149. 0	0. 00	0. 00	0. 00	0. 00
γ 150. 0	0. 00	0. 00	0. 00	0. 00
γ 151. 0	0. 00	0. 00	0. 00	0. 00
γ 152. 0	0. 00	0. 00	0. 00	0. 00
γ 153. 0	0. 00	0. 00	0. 00	0. 00
γ 154. 0	0. 00	0. 00	0. 00	0. 00
γ 155. 0	0. 00	0. 00	0. 00	0. 00
γ 156. 0	0. 00	0. 00	0. 00	0. 00
γ 157. 0	0. 00	0. 00	0. 00	0. 00
γ 158. 0	0. 00	0. 00	0. 00	0. 00
γ 159. 0	0. 00	0. 00	0. 00	0. 00
γ 160. 0	0. 00	0. 00	0. 00	0. 00
γ 161. 0	0. 00	0. 00	0. 00	0. 00
γ 162. 0	0. 00	0. 00	0. 00	0. 00
γ 163. 0	0. 00	0. 00	0. 00	0. 00
γ 164. 0	0. 00	0. 00	0. 00	0. 00
γ 165. 0	0. 00	0. 00	0. 00	0. 00
γ 166. 0	0. 00	0. 00	0. 00	0. 00
γ 167. 0	0. 00	0. 00	0. 00	0. 00
γ 168. 0	0. 00	0. 00	0. 00	0. 00
γ 169. 0	0. 00	0. 00	0. 00	0. 00
γ 170. 0	0. 00	0. 00	0. 00	0. 00
γ 171. 0	0. 00	0. 00	0. 00	0. 00
γ 172. 0	0. 00	0. 00	0. 00	0. 00
γ 173. 0	0. 00	0. 00	0. 00	0. 00
γ 174. 0	0. 00	0. 00	0. 00	0. 00
γ 175. 0	0. 00	0. 00	0. 00	0. 00
γ 176. 0	0. 00	0. 00	0. 00	0. 00
γ 177. 0	0. 00	0. 00	0. 00	0. 00
γ 178. 0	0. 00	0. 00	0. 00	0. 00
γ 179. 0	0. 00	0. 00	0. 00	0. 00
γ 180. 0	0. 00	0. 00	0. 00	0. 00